



Proceedings of the  
2015 Annual Conference on  
Sustainable Research and Innovation (SRI)

---

6-8 May, 2015

*Kenya School of Monetary Studies  
Nairobi, Kenya*

ISSN: 2079-6226



Proceedings of the  
2015 Annual Conference on Sustainable Research and Innovation  
Kenya School of Monetary Studies,  
Nairobi, Kenya  
6 - 8 May, 2015

The final version of the Proceedings will be made available on  
<http://www.jkuat-sri.com/ojs/index.php/proceedings/index>

© 2015 Sustainable Research and Innovation (SRI) Conference

Research, in the 21<sup>st</sup> century, is dependent on the multi-disciplinary approach for development of new knowledge and products. Industrialized countries spend a significant percentage of GDP on funding research in universities and other dedicated research institutions and centres. The challenge for developing countries, however, is that of building up capacity in order to ensure that industries remain competitive in the global markets, in addition to offering innovative solutions to the increasing socio-economic problems and developing efficient methods of using the depleting natural resources. The multi-disciplinary approach is a possible method of tackling these challenges.

The theme for the 2015 Annual conference is 'Sustainable Research and Innovation'. The conference aims to create a forum for scholars, industry and other stakeholder to interact and exchange ideas on new and existing knowledge in the field of engineering and related subjects. The conference is also a forum to enable participants to articulate challenges facing the society, and offer viable solutions. In addition, scholars are also able to create networks for multi-disciplinary and industrial based research that will solve national and international problems. The wide selection of topics listed herein below give the participants an opportunity to share experiences and articulate how their activities impact on the process of industrialization in Africa and other developing countries.

The 2015 Sustainable Research and Innovation Conference is the successor to the Departmental Annual Seminars previously organized by Department of Mechanical Engineering. The first seminar was held in 1995, under the theme: The Role of Mechanical Engineering in Changing Industry. Thereafter, seven seminars were held annually until 2001. After a few years break, the annual seminars resumed in 2006 with the 9th series titled 'Sustainable Research and Innovation' and in 2010 it was upgraded to a conference. This year, the conference has drawn participation from the academic field and industries in Kenya as well as various countries including Japan, Italy, Botswana and Nigeria. This year's conference has been supported by Jomo Kenyatta University of Agriculture and Technology (JKUAT), Kenya Maritime Authority (KMA) and Japan International Cooperation Agency (JICA).

The papers to be presented at the 2015 Sustainable Research and Innovation Conference will include, but are not limited to the following topics:

- i. Environmental management research
- ii. Sustainable research strategies
- iii. Energy generation and supply optimization
- iv. New and renewable energy solutions
- v. Technology transfer to industry and society
- vi. Industrialization strategies for vision 2030
- vii. Climate change and pollution control
- viii. Industrial processes performance and control
- ix. Optimization strategies in transport sector
- x. Emerging manufacturing trends
- xi. Power transmission and utilization
- xii. Communication improvement strategies
- xiii. Mineral exploration, mining and processing strategies
- xiv. Industrial maintenance processes
- xv. Quality management techniques

## CONFERENCE SPONSORS

---

The SRI conference seeks support from well-wishers in order to ensure that all the activities in preparation of and during the conference run smoothly. The donors have no influence over the selection or content of the presentations.

The 2015 Sustainable Research and Innovation Conference has received financial support commitment from the following partners:

### Diamond

---



### Platinum

---



## THE ADVISORY BOARD

---

Prof. Eng. B.W. Ikua  
Jomo Kenyatta University of  
Agriculture and Technology  
Kenya

Prof. G. Nyakoe  
Jomo Kenyatta University of  
Agriculture and Technology  
Kenya

Prof. S.M. Maranga  
Jomo Kenyatta University of  
Agriculture and Technology  
Kenya

Prof. Eng. J.M. Kihiu  
Jomo Kenyatta University of  
Agriculture and Technology  
Kenya

Prof. Eng. S.P. Ng'ang'a  
Jomo Kenyatta University of  
Agriculture and Technology  
Kenya

Dr. K. K. Kaberere  
Jomo Kenyatta University of  
Agriculture and Technology  
Kenya

Prof. B. M. Mati  
Jomo Kenyatta University of  
Agriculture and Technology  
Kenya

Prof. P. N. Kioni  
Jomo Kenyatta University of  
Agriculture and Technology  
Kenya

Dr. Eng. Karanja Kibicho  
Ministry of Foreign Affairs  
Kenya

Prof. F. Gatheri  
Technical University of Kenya  
Kenya

Prof. G. O. Rading  
University of Nairobi  
Kenya

Prof. Enrico Sciubba  
University of Roma  
Italy

Prof. Eiji Tomita  
Okayama University  
Japan

Prof. Hisataka Tanaka  
Tottori University  
Japan

Prof. Liu Zuyan  
Harbin Institute of Technology  
P. R. China

Prof. Krzysztof Badyda  
Warsaw University of Technology  
Poland

Prof. Jaros Milewski  
Warsaw University of Technology  
Poland

Prof. A. Beyene  
San Diego State University  
USA

## THE CONFERENCE SECRETARIAT

---

Prof. G. N. Nyakoe, Dean  
School of Mechanical, Manufacturing  
and Materials Engineering

Dr. H. Ndiritu, Chair,  
Department of Mechanical Engineering

Ms. L. Owino, Chair,  
Department of Mechatronic Engineering

Dr. U. Mutwiwa, Chair, Department  
of Biomechanical and Environmental  
Engineering

Dr. R. Kiplimo, Chair,  
Marine Engineering and Maritime Operations

Dr. B. Rop, Chair,  
Department of Mining, Materials  
and Petroleum Engineering

Dr. O. Muvengi, Convener  
SRI Secretariat

Ms. L. Wanja  
Treasurer

Mr. M. N. Kyalo  
Secretary

Mr. M. Hawi  
Communications Liaison

Dr. Eng. J. Messo  
Member

Dr. S. Ondimu  
Member

Ir. A. Muchiri  
Member

Mr. J. Ngoret  
Member

Ms. R. Ndeda  
Member

Ms. E. Wangui  
Member

Ms. J. Maina  
Member

Mr. J. Wamai  
Member

Mr. G. Bett  
Member

Mr. E. Munyao  
Member

Mrs. L. Rafwa  
Member

## TABLE OF CONTENTS

Foreword.....	i
Conference Themes.....	ii
Conference Sponsors.....	iii
Advisory Board.....	iv
Conference Secretariat.....	v
Table of Contents.....	vi
Key Performance Indicators for Manufacturing Safety in Paint Manufacturing: A Case of the Kenyan Industry; <b>Enoch Kimanzi, Bernard Ikua and Thomas Mbuya</b> .....	1
Performance Testing of Hydraulic Ram Pump; <b>R. N. Mbiu, S. M. Maranga and M. Mwai</b> .....	6
A Review of Unit Commitment in Deregulated Electricity Markets; <b>Adline Kerubo Bikeri, Christopher Maina Muriithi, Peter Kihato</b> .....	9
Sustainability Challenges and Opportunities of Generating Biogas from Water Hyacinth in Ndunga Village, Kenya; <b>Antony N. Kamau, Paul Njogu, Robert Kinyua and Mohamed Sessay</b> .....	14
Wireless Power Transmission using Solid State Tesla Coils; <b>Benard Mumo Makaa</b> .....	23
Simultaneous Consideration of Bus Voltage and Frequency in Load Shedding in a High Voltage AC Network; <b>Charles Mwaniki</b> .....	30
A Novel Method for Lattice Tower Vandalism Eradication; <b>Charles Ndungu and T. Njeru</b> .....	35
Development of Aids to Navigation Information System: A Case Study of Kenya Coast Waters; <b>Magdalene Wanjagi Njuki, Moses Murimi Ngigi</b> .....	38
Assessment of the Safety and Health Hazards in Existing Dumpsites in Kenya; <b>Kenneth Kamumbu</b> .....	46
Assessment of the Contribution of Recapitalization of Nigerian Banks to the Growth of Nigerian Real Sector; <b>Akinyele A. Idowu</b> .....	50
Design of Solar Energy Solution and Payback Scheme for Domestic Households; <b>Ruth Kara Njeri</b> .....	55
Review of Thermal Surface Drilling Technologies; <b>R. Ndeda, S. E. M. Sebusang, R. Marumo and E. O. Ogur</b> .....	61
The Implications of Geology and Structure on Iron Ore Mining at Wanjala Mine, Taita-Taveta County, Kenya; <b>Gilbert Kipng'etich Bett, Peter Keoko, Bernard K. Rop</b> .....	70
Investigation of Slow Light in Single Mode Fibres (SMF) for the Basis of Stimulated Brillouin Scattering and the Application in Sensing; <b>Douglas Osiemo</b> .....	74
Strain Rate Effect on the Tensile Behavior of Fiber Bundles Isolated from Nerve Root; <b>Atsutaka Tamura, Junji Murakami, Takao Koide</b> .....	80
Assessment of Environmental Challenges Posed by Ponds in Katsina City, Northern Nigeria; <b>Suleiman Iguda ladan</b> .....	86



Traffic Analysis in the Reduction of Power Consumption in Cellular Radio Access Network; <b>Shadrack Kimanathi, Philip Kibet, Stephen Musyoki</b> .....	93
The Proposed Gemstone Centre and its Likely Impacts on Small Scale Mining Industry in Taita Taveta County; <b>Seroni Anyona and Bernard Kipsang Rop</b> .....	98
The Character and Profile of Artisanal and Small-Scale Gemstone Mining Community in Taita Taveta County, Kenya; <b>Seroni Anyona and Bernard Kipsang Rop</b> .....	109
Shale Geochemistry of Source Rocks in Lokichar and Chalbi Basins, Northwestern Kenya Rift System; <b>Bernard Rop Gilbert K. Bett and Seroni Anyona</b> .....	126
Performance of Aluminium A356 Alloy based Buckets towards Bending Forces on Pelton Turbines; <b>R. N. Mbiu, S. M. Maranga and H. Ndiritu</b> .....	134
Integration of GIS and Multicriteria Evaluation for School Site Selection A Case Study of Belgut Constituency; <b>Philip Kiprono Talam and Moses Murimi Ngigi</b> .....	138
Statistical Comparison of Experts' Responses in a GIS-AHP Oil Pipeline Route Optimization; <b>Peter M. Macharia, Charles N Mundia and Miriam Wathuo</b> .....	150
Synchronous and Induction Machine Based Distributed Generation Islanding Detection: An Overview; <b>L. O. Mogaka, D. K. Murage, M. J. Saulo</b> .....	160
Effect of Capacitance on Electrical Discharge Machining Using an RC type Pulse Generation Circuit; <b>Kabini S. K., Bojer S. K., Ikua B. W., Kihuu J. M., Nyakoe G. N. and Mwangi J. W</b> .....	165
Developing a Sewerage Management System for Kisii Town Using GIS and Remote Sensing; <b>Henry Abuga, Charles Mundia Ndegwa</b> .....	167
Microwave Enhanced Organic Synthesis Green Chemistry- A Study in Transesterification; <b>Anil Kumar, Abraham Chirchir, David K Some, Kirimi H Kiriamiti</b> .....	179
Design of Adaptive Noise Canceler in Foetal Electrocardiogram Signal Extraction Using Simulated Annealing Algorithm; <b>Kevin Mwongera, Kibet Langat, E. N. Ndung'u</b> .....	187
Design of Adaptive Noise Canceller in Speech Signals Using Simulated Annealing Algorithm <b>Kevin Mwongera, Kibet Langat, E. N. Ndung'u</b> .....	192
Development of a Property Tax Information Management System for County Governments: A Case Study of Kapsabet Sub-county; <b>Faith Jeruto Birir, Moses Murimi Ngigi</b> .....	198
Using geospatial technologies to support compulsory land acquisition in Kenya – a case study of Kanunga – Nyaga road in Kiambu County; <b>Mary Kamunyu, David Kuria, Kenneth Mubea</b> .....	204
Development of a WebGIS Supported Road Traffic Accident Data Management System: A Case Study of Nairobi County; <b>Joseph Nanzala Munyendo, David Kuria and Kenneth Mubea</b> .....	218
Environmental Impacts of Artisanal and Small-scale Mining in Taita Taveta County; <b>Seroni Anyona and Bernard Kipsang Rop</b> .....	228
Determination of the Thermo-physical Properties of Walling Materials for Thermal Comfort in the Sub-Tropic Highland Climate, Kenya; <b>R. N. Kariuki, B. N. Mugwima and J. W. Kaluli</b> .....	242
Influence of Waste Lubrication Oil Combustion on Emissions; <b>B. O. Owiti, H. M. Ndiritu and B. B. Gathitu</b> .....	247

Pitting Corrosion Behavior of Duplex Stainless Steel (2205) in Thiosulfate-chloride Environment and in Simulated Hydrothermal Reactor /autoclave; <b>John Gerald Odhiambo, Li Zhang, Shen Yuanyuan, E. Musango Munyao, Lihua Dong</b>	254
A Review of Heliostat Technologies used in Concentrated Solar Power Plants; <b>Timothy Kiptui Kangogo and Karanja S. Kabini</b> .....	258
Use of the Maturity Method in Quality Control of Concrete: A Review; <b>Allan M. Kaburu, J.W. Kaluli and C. K. Kabubo</b>	264
Effect of Exhaust Gas Recirculation on Performance and Emission Characteristics of a Diesel Engine; <b>M. Hawi, R. Kiplimo, H. Ndiritu and E. Munyao</b> .....	267
Impact of training in manufacturing skills on growth of smallholder agro-processing industry in Bureti Sub county, Kericho County, Kenya; <b>J. Bittar Odoyo, Raphael O. Nyonje and Adhiambo Rawago-Odoyo</b> .....	273
The use of Separability Number and SARA Fractionation in Studying Asphaltenes Stability in Residual Fuel Oil; <b>John Otieno Odhiambo, Wei HaiJun, Jotham Muthoka Munyalo and Jia Fengguang</b> .....	281
A Review On Voltage Stability Improvement Using Artificial Neural Network Controlled Facts Devices; <b>Ariel Mutegi, C. M. Muriithi and M. J. Saulo</b> .....	288
Improved biogas production over immobilized methanogenic consortia; <b>Abraham Chirchir, A. Aoyi, K. Kiriamiti and A. Kumar</b> .....	294
Comparing the Performance of Linksys and D-Link under LOS Conditions; <b>Oteri Omae, Ndungu E. N and Kibet P. L</b> .....	304
Comparison of Wi-Fi Signal Indoor LOS Coverage and Propagation through Walls; <b>Oteri Omae, Ndungu E. N and Kibet P. L</b> .....	308
The distribution and reproductive patterns of the <i>Epinephelus</i> genera groupers off Kenyan South Coast inshore marine waters; <b>Ogongo Bernard Ochieng and Orembo B. Okeyo</b> .....	313
Analysis of Wind Power Integration for Power System Transient Stability; <b>James Kinyua Muriuki, C. M. Muriithi and L. M. Ngoo</b> .....	319
Fracture Mechanics Approach to Pressure Vessel Failures: A Review; <b>Joseph Mutava, Mutuku Muvengei, Kenneth Njoroge, John Kihuu</b> .....	328
Simulation of Drying Uniformity inside Hybrid Solar Biomass Dryer using ANSYS CFX; <b>Jackis Aukah., Mutuku Muvengei., Hiram Ndiritu and C. Onyango</b> .....	336
Tool Wear, Wear Mechanism and Dimensional Accuracy in Machining Al <sub>2</sub> Ti <sub>2</sub> SiCp MMC using CBN and PCD Tools; <b>Muguthu Joseph Njuguna and Dong Gao</b> .....	345
An Evaluation of Maintenance Practices in Kenya: Some preliminary results; <b>A. K. Muchiri, B.W. Ikuu, P.N. Muchiri, P.K. Irungu and K. Kibicho</b> .....	350
Application of Taguchi method in optimization of Electrical Discharge Machining of AlSiC Metal Matrix Composites; <b>Mwangi J. W, Ikuu B. W, Nyakoe G. N, Kabini S. K and Makenzi M. M</b> .....	355
Scouring abandoned mines in search for elusive metal (gold) in Kakamega's Rosterman area - A case study in Kenya; <b>Mathew Ndeto Kyalo, Irene Fedha Munyerere, B. Rop and S. M. Maranga</b> .....	362
Prediction of in-cylinder Conditions for a 2-stroke Marine Diesel Engine; <b>Elijah Musango Munyao, Jiang Guohe, Meshack Hawi, John Gerald Odhiambo</b> .....	367
In-situ Synthesis of Al-based Composites Reinforced with TiB <sub>2</sub> -TiC-Al <sub>2</sub> O <sub>3</sub> Ceramic Particulates; <b>Takahiro Akao, Kaname Tonoko, Tetsuhiko Onda, Zhong-chun Chen</b> .....	371

List of Contributors..... 371

# Key Performance Indicators for Manufacturing Safety in Paint Manufacturing: A Case of the Kenyan Industry

Enoch Kimanzi, Bernard Ikua and Thomas Mbuya

**Abstract**—Manufacturing safety is a key priority in the success of any business, as it can affect both the present and future competitive position of an organization. Organizations must measure safety in order to find areas of weakness, and then implement actions aimed at raising safety levels. Industrial accidents in the chemical industry indicate a need for both leading and lagging indicators of safety in the workplace. The purpose of this study was to formulate and validate a set of key performance indicators that can be used in the measurement and reporting of manufacturing safety, and ensure a safe working environment for the workers on a continuous basis. The results consisted of 21 Key Performance Indicators (KPIs), with fire safety being the most relevant KPI. The information gathered during a manufacturing safety performance measurement exercise can be used to implement activities directed towards reducing the level of worker exposure to health and safety risks within the factory.

**Keywords**—key performance indicators, manufacturing safety, paint, performance measurement

## I. INTRODUCTION

THE expanding global economy has brought in new challenges into the business world. Such challenges include increased competition for the diminishing resources, competitive global markets, fast technological innovations, and need to protect the environment on a larger scale. To survive in the face of these challenges, three competitive priorities, i.e. quality of the product/ service, cost of production and cycle time have been emphasized [1].

Another important business success factor that has not received due attention is safety at the workplace [1]. This has partially been attributed to the difficulty of implementing safety programs given the available resources and skills in most organizations [2]. Industrial accidents can influence an organization's present and future competitive position [3]. An example is the Piper Alpha disaster at the United Kingdom (UK) North Sea in 1986 which claimed 184 lives and led to the closure of Occidental's operations at the UK Continental shelf [3].

An injury-free working environment creates a positive

employee attitude and improved motivation, results in higher quality of outputs and lower production costs due to decreased rework, scrap, lost time, worker's compensation and lost workdays. The ultimate safety goal of a business should thus be to provide a productive and safe working environment for all employees. It is on the basis of this argument that organizations should aim at creating a positive safety climate within the workplace. Reference [4] defines safety climate as "a summary of molar perceptions that employees share about their work environments; a frame of reference for guiding appropriate and adaptive task behaviours." Safety climate simply reflects the workers' attitudes towards safety [5].

Industrial safety has been of concern in every other industry. For instance, in the United States of America (USA) alone, 44,000 to 98,000 patients die each year in the healthcare industry due to treatment errors, costing the government between \$17 and \$29 billion [6]. In the UK manufacturing sector, 41 fatalities, 6,809 major injuries, and 32,550 over three day absences were recorded during the 2002-2003 period [5].

The chemical industry has witnessed many fatal accidents over the last five decades. In June 1974, the Nypro (UK) site at Flixborough exploded killing 28 people and injuring another 36 [7]. The cause of the explosion, according to the court of inquiry, was a leakage of cyclohexane from a bypass pipe fixed two months earlier to enable repairs on a malfunctioning reactor tank. The cyclohexane vapour cloud explosion completely destroyed the plant.

In July 2006, a fire accident in a paint manufacturer's premises at Libra House, Kenya, resulted in over 10 casualties [8], [9]. According to [9], poor safety management, lack of appropriate warehousing facilities and compromising of safety for security were the main contributing factors to the accident. Another 8 employees lost their lives in the Kariobangi Light Industries' Picasso Chemicals factory fire accident in May 2011 [10].

The September 2011 Kenya Pipeline Company (KPC) oil pipeline tragedy claimed an estimated 75 lives [11]. According to [12] and [13], the cause of the oil spill was a ruptured gasket. Oil spilled into a nearby storm drain and heavy rains washed the oil into the Sinai village. The oil ignited and killed 75 persons and injured more than 120 others.

E. M. Kimanzi, Department of Mechanical Engineering, JKUAT (phone: +2540727559097; e-mail: enoch.kimanzi@uonbi.ac.ke).

B. W. Ikua, Department of Mechanical Engineering, JKUAT (e-mail: ikua\_bw@eng.jkuat.ac.ke).

T. O. Mbuya, Department of Mechanical and Manufacturing Engineering, UoN (e-mail: tmbuya@uonbi.ac.ke).

These statistics and others not mentioned here, point to the fact that accidents can occur due to several factors. Such factors include: human error, negligence, natural cause and unprofessional operation of equipment. The government of Kenya has made minimal efforts to regulate the hazards and risks posed by paint manufacturers both to their workforce and product users [14], [15]. This necessitates research into how manufacturing safety levels can be raised in chemical industries and more so paint manufacturing firms in Kenya.

Organizations can be reactive or proactive when dealing with safety issues in the workplace [18]. The reactive approach as a means of reducing accident losses has many shortcomings. The approach permits many fatalities and injuries to occur for evaluation of needs and priorities in safety measures [19]. Reference [19] proposes the integration of the safety management system into the total quality management program of an organization. Reference [1] proposes that organizations should use a more predictive strategy that monitors safety and health performance in operation (proactive approach).

CI unceasingly strives to improve the performance of production and service firms [20]. Performance improvement through CI has been witnessed at Motorola, General Electric, Honda, Honeywell and Sony among others [21]. The concept can be applied by organizations to raise their manufacturing safety levels as well.

The role of KPIs in improving performance is closely interrelated to risk management, performance management and benchmarking [17]. Risk management deals with risk perception, risk identification and risk audit. Performance measurement enables good planning, contributes to continuous improvement, and improves resource allocation [22], [23]. Benchmarking enables comparison between an organization and the best in the industry. A benchmark serves as a standard against which relative performance can be measured, whether internal or external. KPIs are good in identifying the performance data required and also in pointing out the shortcomings in available data. They enable an organization to benchmark the right attributes of performance. KPIs can be broadly classified into two categories: leading indicators and lagging indicators. Lagging indicators show how an entity has performed to date in a certain area. Leading indicators predict how that entity will perform in the future. Program performance may not be adequately addressed by either indicator category alone. Lagging indicators are characterized by time delay and may provide information too late for the right action to be taken. The leading indicators may fail to link the expected outcomes to the right operational activities. Both lagging and leading indicators should hold the potential to show some improvement over a given period of time.

According to reference [24], the practical use of KPIs involves industry-specific or organization-specific indicators. This may be so due to their specific context of application. A performance measurement system should not contain too many nor too few performance indicators. Too many

indicators may lead to loss of focus while too few may provide poor judgement as to the true performance of an organization or a part of it.

Reference [25] suggests a set of between seven and twelve indicators, although other literature shows that this number depends on the industry [24], [26], [27]. Once the main KPIs have been formulated, an organization can then define the sub-KPIs from which it can readily collect data for use in continuous improvement.

Key Performance Indicators (KPIs) are identified based on the objective that a Continuous Improvement (CI) program seeks to achieve [16]. This is usually so because a CI program seeks to close the gap between the status quo and the desired target. The next step is to identify opportunities for improvement and prioritize them based on return and criticality [17]. An action plan is then developed and implemented, and the results evaluated against the desired target. This becomes a cyclic process.

The most common KPI in health and safety has been accident and incident rate [1], [3]. Other key indicators are accident costs, investment in safety, levels of communication on health and safety issues, workforce involvement, health and safety policies, organizing for safety and management commitment to health and safety. Also important are testing of employee knowledge on health and safety issues, number of implemented corrective actions within agreed time scale, level of achievement in health and safety plans, sick leaves, absence due to injuries, and maintenance lag.

Industrial accidents in Kenyan paint manufacturing firms have led to loss of lives and impacted negatively on the national economy. The management of health and safety in any organization requires the selection, measurement and management of the right indicators [3]. The intent of this research was therefore to come up with a list of KPIs that can be applied to raise safety levels in paint manufacturing firms in Kenya and other developing countries. An initial list of KPIs was derived from existing literature and examination of risk factors in the manufacture of paint and allied products. This was then improved on during expert interviews and later validated using questionnaires.

## II. METHODOLOGY

### A. Research Design

A formal, communication type of study in form of a case study of the paint manufacturing industry was adopted. Expert interviews were conducted to enable formulation of health and safety KPIs in this industry. Questionnaires were then developed and distributed with the aim of collecting data that would enable validation of the formulated KPIs.

### B. Research Framework

The study involved two phases. Phase 1 of the study aimed to collect data on health and safety performance KPIs in the paint manufacturing industry. This data was then analyzed with the objective to come up with an initial list of health and safety KPIs. Phase 2 involved validation and prioritization of

the KPIs. Data collected during phase 2 was analyzed with the aim of producing a refined list of the KPIs.

### C. Study population

The population consisted of the production managers, safety professionals and other personnel directly involved in the planning for health and safety in paint and allied products manufacturing firms in Kenya. There are 23 paint and allied products manufacturing firms in Kenya [28].

A sample of 12 respondents was selected for participation in the interview stage of this study, of which 5 were large scale manufacturers and 7 were small scale manufacturers. Purposive sampling was used to select sample elements. The objective of using this form of sampling was to enable the researcher select those respondents who were experienced enough in the handling of safety programs within their workplace so as to provide relevant data to this study.

Elements from firms with established health and safety departments were among the first to be included in the sample. This was necessary to ensure that most of the required data was captured as these firms have better established safety infrastructure in place. In the validation phase of the study, since the questionnaire was easy to administer, a census survey of the 23 firms was used.

### D. Data Collection and Processing

Data was collected from the respondents using structured interviews and self-administered questionnaires. Structured interviews were used to collect data on different KPIs that formed the initial list. Validation questionnaires were designed and used to validate the KPIs generated in the interview phase of the study.

Literature synthesis and review of safety risks involved in the manufacturing of paints and allied products was used to supplement the data on KPIs that were collected from the selected field experts. It was also a good guide to the researcher in establishing points of authority from the interviewees.

Case analysis was used to analyze the responses collected during the interviews. Descriptive statistics such as mean and standard deviation were used to summarize the coded data.

## III. RESULTS AND DISCUSSION

### A. Analysis of Interview Responses

A total of 6 structured interviews were conducted in the first phase of the study. This represents 50% of the initial target of 12 interviews. The interview phase of this study sought data that was rich enough to provide a source for extracting relevant KPIs. To provide this kind of data, it would require the participant to be well knowledgeable in handling health and safety in the manufacturing setup.

Five of the six firms that participated in the interviews had established departments handling health and safety. Only one firm did not have such a department, but nonetheless, had a production manager who doubled as the head of safety. The other six firms that declined the interview are all light companies operating within residential areas.

A list of 21 KPIs was extracted from the 6 responses. The KPIs are as shown in Table I.

TABLE I  
KEY PERFORMANCE INDICATORS

Validated Key Performance Indicators	
• Accident and incident rates	• Maintenance function
• Cost of accidents	• Fire safety
• Management input	• Water supply
• Worker skill	• Warehousing/ material handling function
• Worker commitment and integrity	• Space utilization
• Plant Air quality	• Book Keeping
• Noise exposure	• Risk response
• Spillage management	• Communication
• Level of lighting	• General health of workers
• Safety gear	• General cleanliness of premises
• Waste disposal	

### B. Analysis of Questionnaires

A total of 23 questionnaires were distributed to all paint and allied products manufacturing firms in Kenya. A total of 11 duly filled questionnaires were collected. This represents a response rate of 47.8%. The respondents included some of those firms that had participated in the interview stage as well as those that did not. The inclusion of participants that were not part of phase 1 of the study was necessary to ensure validity of the data being sought for.

### C. Descriptive Statistics

The data was processed and the mean and standard deviation for each KPI computed. These values are important because they indicate what the industry perceives to be the right approach in terms of handling health and safety. Table II shows the computed Mean and Standard Deviation for each KPI. The KPIs are arranged in the decreasing order of the Mean, 9.91 being the highest and 8.0 being the lowest. The relevance scale of 1-10 points was divided into three regions, Least Relevant (0-2.9), Medium Relevance (3.0-6.9) and Most Relevant (7.0-10). Those with a mean value in the region of Least Relevance were to be dropped out of the list and retain only those KPIs with a mean value of 3.0 and above. The results show that all KPIs were relevant and therefore qualified to be part of the refined list of manufacturing safety KPIs.

TABLE II  
MEAN AND STANDARD DEVIATION STATISTICS

Rank	Descriptive Statistics		
	Key Performance Indicator	Mean	Standard Deviation
1	Fire safety	9.91	0.302
2	Waste disposal	9.82	0.405
3	Space utilization	9.73	0.905

Rank	Descriptive Statistics		
	Key Performance Indicator	Mean	Standard Deviation
4	Plant Air quality	9.55	0.934
5	Spillage management	9.55	0.522
6	Safety gear	9.55	0.934
7	General health of workers	9.55	0.820
8	Worker skill	9.45	1.214
9	Warehousing/ material handling function	9.45	0.820
10	Risk response	9.45	1.293
11	Communication	9.45	1.036
12	Noise exposure	9.36	0.809
13	Maintenance function	9.36	2.111
14	Accident and incident rates	9.18	2.089
15	General cleanliness of premises	9.09	1.921
16	Worker commitment and integrity	9.00	1.732
17	Level of lighting	8.91	1.640
18	Cost of accidents	8.73	2.284
19	Management input	8.73	2.687
20	Book Keeping	8.09	2.256
21	Water Supply	8.00	3.130

#### D. Nomenclature of the Key Performance Indicators

Respondents to the validation questionnaires were asked to suggest a different name for each of the KPIs depending on the actual names used in the industry, Health, Safety and Environment (HSE) audit requirements, and professional expertise, where applicable. 4 suggestions were made that the Book Keeping KPI should be renamed to Record of Past Incidences, Register Keeping, HSE Audits or Documentation. Documentation was adopted. The main reason for adopting this new nomenclature for the KPI was that Book Keeping could easily be confused with the book keeping function in accounting and also it was seen to fully define the measure in question.

Two out of the 11 respondents indicated that the Cooling Water Supply KPI should be renamed to Water Supply or Cooling Systems. The Water Supply suggestion was adopted since the argument was that both cooling and cleaning depend on water supply. This implies that water supply should be adequate for both functions which independently influence safety.

One respondent indicated that Safety Gear, Risk Response and Communication KPIs should be renamed to Personal Protective Equipments, Emergency Response and Internal & External Communication respectively. Risk Response was retained since the KPI involved both emergencies occurring within the premises and the policies in place to mitigate incidents, which may not adequately be covered under the

nomenclature of Emergency Response. The other two suggestions, that is, Personal Protective Equipments and Internal & External Communication were also not adopted since a majority of 10 out of 11 respondents indicated that the initial nomenclature assigned by the researcher was satisfactory. The respondents unanimously considered all the other 16 KPIs to have been appropriately named. This new nomenclature of the 2 KPIs was adopted for the final list of KPIs.

#### E. Additional Key Performance Indicators

The respondents were also asked to suggest other key performance indicators that may not have been captured in the validation questionnaire. 1 respondent indicated that training, first aid and conformity to legal requirements and other bodies should have been among the suggested KPIs. Training had been covered under Management Input as training relating to health, safety and environmental activities, and also under Worker Skill as training relating to the profession of the worker. It was therefore not included in the refined list of KPIs as a standalone KPI.

First Aid is an event that takes place in response to an accident or an incident, to stop the worsening of a condition as the victim awaits medical attention, or as remedy to minor mishaps. The cost of offering first aid can be measured, making first aid measurable in the sense of cost. However, the researcher had bundled this cost among other costs under Cost of Accidents and did not therefore qualify to be a KPI on its own.

Conformity to legal requirements and other bodies by an operational unit is an element that reflects the basic minimum requirements that have to be met to ensure continued operation of business and avoid related penalties. The intent of this research was to provide a model from which paint and allied product firms can design safety activities with the aim of achieving “zero defects”, that is, zero incidents in the management of health and safety.

Conformity to legal requirements and other bodies will only ensure that the basic minimum requirement is achieved and does not necessarily promote continuous improvement. Moreover, conforming to legal requirements is not optional; it is mandatory. According to [29], KPIs should be oriented towards improvement and not to conformance. Conformity cannot therefore be used as a KPI but as the first requirement to the application of the KPI model, which was the object of this research.

The results from the validation stage showed that all the 21 KPIs were highly relevant in the measurement and management of health and safety within the paint manufacturing industry. Only the nomenclature of one KPI changed from Book Keeping to Documentation. The KPI with the least mean was Water Supply with a mean value of 8.00 and standard deviation value of 3.13. Since the respondents were asked to score each KPI on a range of 1 to 10 points, a mean value of 8.00 would indicate highly relevant. Fire Safety was ranked the first with a mean value of 9.91 and standard deviation value of 0.302. This can be attributed to the

presence of highly inflammable liquids within the factory and the need to protect workers from fire risk.

Another important point to note is that the 21 KPIs consisted of 17 leading KPIs and 4 lagging KPIs. The 4 lagging KPIs, that is, general health of workers, accident and incident rates, cost of accidents, and documentation, appeared among the least relevant KPIs. This implies the acceptance by this particular industry that leading indicators, which promote proactive behavior towards manufacturing safety, are more desired as compared to lagging indicators.

#### IV. CONCLUSION

The use of key performance indicators in any process enables benchmarking of the process to the best-in-class practices, as practiced by world class manufacturing firms. This promotes the objectives of such programs as continuous improvement and lean manufacturing, and also prompts those in process quality monitoring and control to find ways of achieving new targets of quality. This study focused on manufacturing safety as one of the most important areas in manufacturing. Manufacturing safety can negatively influence product costs in cases where too many incidents or accidents occur. It can also affect public goodwill, corporate image and employee turnover rate.

The results of this research showed that all the identified 21 KPIs are necessary in the measurement and reporting of manufacturing safety within paint manufacturing firms. The results also showed that fire safety is the most important KPI. The nomenclature used was found to be satisfactory.

#### REFERENCES

[1] A. Ansari, and B. Modarress, "World-class strategies for safety: a Boeing approach", *International Journal of Operations & Production Management*, vol. 17(4), pp. 389-98, 1997.

[2] J.-C. Le Coze, "Outlines of a sensitising model for industrial safety assessment", *Safety Science*, vol. 51, pp. 187-201, 2012.

[3] K. Mearns, and J. I. Håvold, "Occupational health and safety and the balanced scorecard", *The TQM Magazine*, vol. 15(6), pp. 408-23, 2003.

[4] D. Zohar, "Safety climate in industrial organizations: theoretical and applied implications", *Journal of Applied Psychology*, vol. 65, pp. 96-102, 1980.

[5] S. Clarke, "Safety climate in an automobile manufacturing plant: The effects of work environment, job communication and safety attitudes on accidents and unsafe behavior", *Personnel Review*, vol. 35(4), pp. 413-30, 2006.

[6] T. Katz-Navon, E. Naveh, and Z. Stern, "Safety self-efficacy and safety performance: Potential antecedents and the moderation effect of standardization", *International Journal of Health Care Quality Assurance*, vol. 20(7), pp. 572-84, 2007.

[7] Health and Safety Executive, "Flixborough Nypro (UK) Explosion 1 June 1974: Accident summary", 1975. Retrieved February 22, 2013, from <http://www.hse.gov.uk/comah/sragtech/caseflixboroug74.htm>

[8] Ministry of State for Special Programmes, "Draft national policy for disaster management in Kenya", 2009. Retrieved April 2, 2013, from <http://www.ifrc.org/docs/idrl/765EN.pdf>

[9] S. Lehtinen, M. Joronen and S. S. Hinkkanen, (eds), "Accident prevention – A safe workplace", *African Newsletter on Occupational Health and Safety*, vol. 19(1), 2009. Retrieved April 2, 2013, from [http://www.ttl.fi/en/publications/electronic\\_journals/african\\_newsletter/Documents/african\\_newsletter1\\_2009.pdf](http://www.ttl.fi/en/publications/electronic_journals/african_newsletter/Documents/african_newsletter1_2009.pdf)

[10] C. Ombati, "Eight workers die in chemical factory fire", ICT Fire & Rescue, May 26, 2011. Retrieved April 2, 2013, from <http://ictfire.com/news/?p=253>, unpublished.

[11] Society for International Development, "Disaster preparedness in the GHEA: Taking a leaking ship to the high seas?," *Greater Horn of East Africa (GHEA) Outlook*, vol. 24, 2012. Retrieved June 18, 2013, from <http://www.sidint.net/docs/RF24.pdf>

[12] Kenya Alliance of Resident Associations, "Disasters: The elusive quest for disaster prevention and management," *Neighbourhood*, vol. 18, 2011. Retrieved August 5, 2013, from <http://kara.or.ke/resources/KARA%20OCTOBER%202011%20ISSUE.pdf>

[13] Mars Group Kenya, "Kenya Pipeline Company – Sinai fire disaster report callous to the extreme", 2012. Retrieved August 5, 2013, from <http://blog.marsgroupkenya.org/?p=2843>, unpublished.

[14] Ministry of Environment and Mineral Resources, "Kenya national profile to assess the chemicals management," 2011. Retrieved March 19, 2013, from <http://www.environment.go.ke/saicm/wp-content/uploads/2011/10/Kenya-National-Chemicals-Final1.pdf>

[15] C. Nganga, S. Clark and J. Weinberg, "Lead in Kenyan household paint," 2012. Retrieved March 19, 2013, from <http://ipen.org/iccm3/wp-content/uploads/2012/09/Lead-in-Kenyan-Household-Paint.pdf>

[16] A. S. I. Raouf, "Productivity enhancement using safety and maintenance integration: an Overview," *Kybernets*, vol. 33(7), pp. 1116-26, 2004.

[17] A. Enoma and S. Allen, "Developing key performance indicators for airport safety and security," *Facilities*, vol. 25(7), pp. 296-315, 2007.

[18] A. Waring, "Corporate health and safety strategy," *Facilities*, vol. 14(3/4), pp. 52-55, 1996.

[19] S. C.-K. Yu and B. Hunt, "A fresh approach to safety management systems in Hong Kong," *The TQM Magazine*, vol. 16(3), pp. 210-15, 2004.

[20] W. I. Zangwill and P. B. Kantor, "Toward a theory of continuous improvement and the learning curve," *Management Science*, vol. 44(7), pp. 910-20, 1998.

[21] N. Bhuiyan and A. Baghel, "An overview of continuous improvement: from the past to the present," *Management Decision*, vol. 43(5), pp. 761-71, 2005.

[22] D. Sinclair and M. Zairi, "Effective process management through performance management," *Business Process Re-Engineering and Management Journal*, vol. 19, pp. 46-51, 1995.

[23] A. Rose, "Measuring operational safety in aviation," *Aircraft Engineering and Aerospace Technology: An International Journal*, vol. 78(1), pp. 26-31, 2006.

[24] J. Hinks and P. McNay, "The creation of a management-by-variance tool for facilities management performance assessment," *Facilities*, vol. 17(1/2), pp. 31-53, 1999.

[25] S. F. Slater, E. M. Olson and V. K. Reddy, "Strategy based performance measurement," *Business Horizons*, vol. 40(4), pp. 37-44, 1997.

[26] O. O. Ugwu and T. C. Haupt, "Key Performance Indicators for infrastructure sustainability – A comparative study between Hong Kong and South Africa," *Journal of Engineering, Design and Technology*, vol. 3(1), pp. 30-43, 2005.

[27] S. Bäckström, H. Kyster-Hansen, M. Swahn and M. Blinge, Green Corridor Manual – Key Performance Indicators (KPIs) and policy measures in green transport corridor establishment. Karlshamn: NetPort.Karshamn, 2012.

[28] Kenya Postel Directories, Paints – Wholesale and manufacturers, 2013. Retrieved March 19, 2013, from <http://www.yellowpageskenya.com/search/?business=Paint-Wholesale+%26+Manufacturers&locality=&category=PaintWholesale+%26+Manufacturers&sorta=&start=0&page=1>, unpublished.

[29] E. Roubtsova and V. Michell, "Modelling and Validation of KPIs," 2013. Retrieved April 29, 2014, from [http://portal.ou.nl/documents/114964/20294245/TuW\\_symposium\\_20131123\\_elr\\_2.pdf](http://portal.ou.nl/documents/114964/20294245/TuW_symposium_20131123_elr_2.pdf), unpublished.



# Performance Testing of Hydraulic Ram Pump

R.N. Mbiu<sup>1\*</sup>, S. M. Maranga<sup>2</sup> and M. Mwai<sup>3</sup>

**Abstract**— Convectional water pumping methods that mainly depend on use of fossil fuel have become more and more uneconomical to maintain especially in developing countries. To replace these non-renewable energy sources many different alternative power sources are being researched on and implemented. One such renewable energy source is use of hydraulic ram pumps (hydrams) where rivers or streams with a considerable gradient are available. The hydraulic ram pump can be a viable and appropriate renewable energy water pumping technology. This paper highlights on design development of a durable and locally made hydram using inexpensive and readily available materials. A test rig was also fabricated and used to analyze the different parameters of the hydram i.e. the waste valve weights, pumping pressures, corresponding head and stroke lengths. Optimizing these parameters ensures that the hydram performance is enhanced and as a result giving the pump a longer life. The testing projected to solve major problems encountered in the operation of the hydram i.e. tuning of the valves for best performance of the pump. Experimental and analytical modeling results were generalized in Performance charts and compared to commercially available types operating characteristics. These results will enable targeted users to be able to select appropriate sizes for their water pumping needs.

**Keywords**— Water pumping, Hydraulic ram pump, Test rig.

## I. INTRODUCTION

KENYA is a country that is highly dependent on Agriculture, water plays major role [1]. With the changing climatic patterns [2], it has become difficult to depend on rain water hence the need for cheap ways of pumping water from a reservoir or river, which can be used for both domestic and agricultural use. Furthermore, environmental concern has also become one of the main issues worldwide due to its impact on health matters. The convention pumps uses fossil fuels which are also expensive hence the need to develop a cheap pump that is durable and easy to maintain.

The use of hydraulic ram pump is a viable and appropriate renewable energy water pumping technologies that have been employed to address the issue [3]. Different people have tried different kinds and designs of hydrams and the main challenges are the high noise from the waste valve, consistence wear on the waste valve rubber and corrosion problems [4]. This research addresses these challenges by making uses of aluminium alloy and optimizing on the weights at the waste valve.

The hydram is a simple pump which requires no external source of energy. This type of pump would not worry the user in the event that there is power blackout hence making it more reliable [5]. Due to the constant supply of water

given that the water source is constant as well, agriculture activities would very well thrive and hence leading to strong economy.

## II. GOVERNING EQUATIONS

The working principle of a hydraulic ram pump is that the pump uses the momentum of a relatively large amount of moving water on a lower level to pump a relatively small amount of water to a higher level.

A pipe is run from the pond to the pump which has a valve that allows water to flow through this pipe and build up pressure. The pump uses the water hammer effect to develop pressure that allows a portion of the input water to be lifted to a point higher than where the water originally started [6]. The amount of water pumped per day is calculated as:

$$D = (Q_2 * H * E)/h \quad (1)$$

Where:

- D = Amount delivered in liters per 24 hours. [m<sup>3</sup>/s]
- Q<sub>2</sub> = Quantity of water supplied in liters per minute. [m<sup>3</sup>/s]
- H = Fall or height of the source above the ram [ m]
- E = Efficiency of the ram
- H = Lift height of the point of use above the ram [m]

A hydram makes use of sudden stoppage of flow in a pipe to create a high pressure surge; the volumetric discharge from the drive pipe is given by:

$$Q = VA \quad (2)$$

Where,

- A = Area [m<sup>2</sup>]
- V = Velocity of flow. [m<sup>3</sup>/s]
- Q = Volumetric flow rate through the pipe. [m<sup>3</sup>/s]

The velocity of fluid flow in the driven pipe is given by

$$V_d = \frac{Q_d}{A_d} \quad (3)$$

Where,

- V<sub>d</sub> = Velocity of fluid flow[m<sup>2</sup>/s]
- Q<sub>d</sub> = Delivered volume [m<sup>3</sup>/s]
- A<sub>d</sub> = Area of the driven pipe [m<sup>2</sup>]

The efficiency E of the hydram is given by

$$E = (Q_d \times H_d) / [(Q + Q_w) \times H] \quad (4)$$

Where,

R. N. Mbiu, Department of Mechanical Engineering, JKUAT (phone: +254 720 568 273; e-mail: rnjihia2003@gmail.com).

S. M. Maranga, Department of Mechanical Engineering, JKUAT (e-mail: smmaranga@yahoo.com).

- E= Efficiency of the hydam
- $Q_d$ = Pumped flow [ $m^3/s$ ]
- $Q_w$  = Wasted flow [ $m^3/s$ ]
- H = Pump drive/supply head
- $H_d$  = Total head above the waste valve opening  
= (H+h) [m]
- H= Delivery head [m]

Operation time for the waste valve i.e. time during which velocity in supply pipe builds is given by;

$$t_1 = L \times \frac{V_d}{(h-H)g} \quad (5)$$

Where,

- H = Supply head [m]
- h = Delivery head [m]
- L= Drive pipe length [m]

### III. METHODOLOGY

A hydraulic ram pump was designed and fabricated using casting technology as shown in Figure 1. Recycled aluminium alloy which is locally, reliable and not expensive was used. The pump was also less susceptible to corrosion giving it a longer life span compared to those once fabricated from mild steel or G.I pipes. The aluminium alloy of tensile strength of 286Mpa was considered in the casting of the hydam body. The alloy is able to withstand the high pressures developed in the hydam air chamber [7].

Once pump was made, there was need for testing in order to determine the optimum conditions of operation. In the design of the test rig, the following variations were considered;

- i. Weights on the waste valve
  - ii. Heights of the supply head and
  - iii. Lengths of the drive pipe.
- These variations gave different results in;
- i. Delivery head
  - ii. The flow rate available
  - iii. The quantity of water to be delivered.
  - iv. Pressures in the air chamber
  - v. Waste valve frequency (strokes per second)

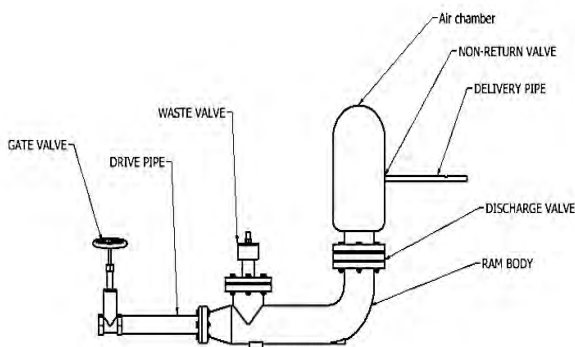

Fig. 1. Hydraulic Ram Pump

The delivery pipe was placed at a height approximately 6.82m but the water discharge could be to a higher height. The length of the pipe was 10 m and a diameter of 12.7mm. The drive pipe was getting water from a source at a head of 3.5 m, 2.5 m and 1.5 m. Its length was 5 m and a diameter of 50.8 mm.

The weights on the waste valve were 0.41 Kg, 0.64 Kg, 01.06 Kg, 1.40 Kg, 1.70 Kg, 2.04 and 3.1 Kg. With each mass, performance parameters of the hydam were recorded. These were; the discharge, pressure at the water exit from the hydam and the number of oscillations of the waste valve per second.

From the obtained data, other performance characteristics of the hydam were determined. These were; velocity of fluid flow in the discharge pipe, power required propelling the water, pressure at the drive pipe exit point and the operation time.

### IV. RESULTS AND DISCUSSION

Hydraulic ram pump test rig was fabricated as shown in Figure 2 and used to get the different parameters of the hydam that is, the waste valve weights, different working pressures on the air chamber and the delivery pipes, delivery heads and stroke frequencies. Provision for adjusting the head (H) allowed tests to be carried out at different drive heads.

Optimizing these parameters ensures that the hydam efficiency was increased and assurance of a pump with a longer life span.

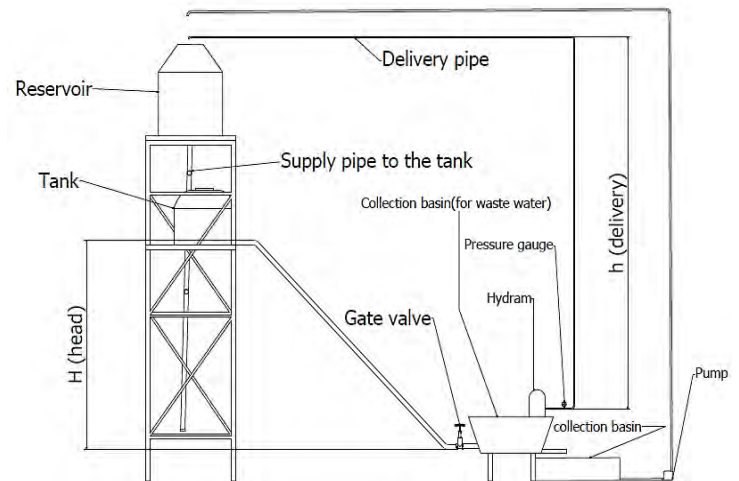
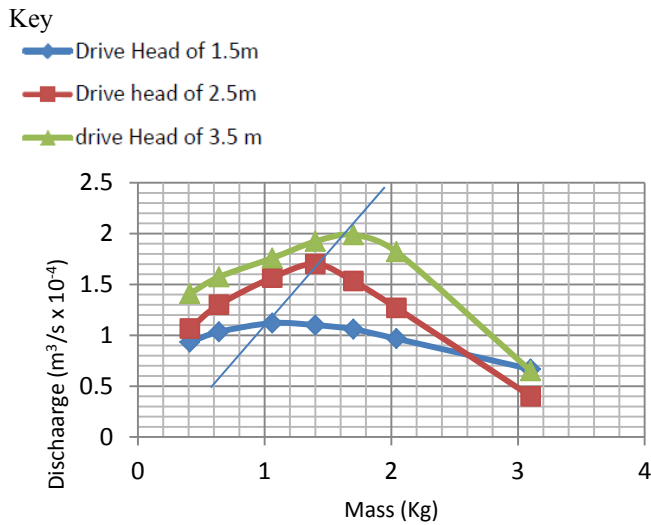

Fig. 2. Hydam Test Rig

The test rig was designed and the assembled hydraulic ram pump and other components from the source tank to the water delivery were connected. The hydam was tested with different weights on the waste valve.

The test rig intended to solve major problems encountered in the operation of the hydam like tuning of the waste valve weights to reduce on wear of the waste valve rubber, material selection that absorbs most of the noise and material that is resistance to corrosion for the best performance of the pump.



**Fig. 3.** A graph of discharge against mass at different drive heads

The amount of discharged water increases with an increase in the mass of the waste valve to an optimum quantity and thereafter, an increase in the mass of the waste valve causes a corresponding decrease in discharged water as show in Figure 3. Here, the masses that gave the optimal discharge were noted as the optimum masses for a given drive head.

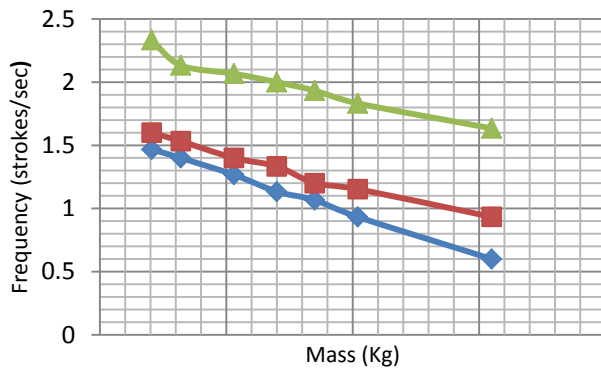

**Fig. 4.** A graph of discharge against frequency at different drive heads

Similarly an increase in the waste valve masses decreases the frequency linearly as shown in Figure 4.

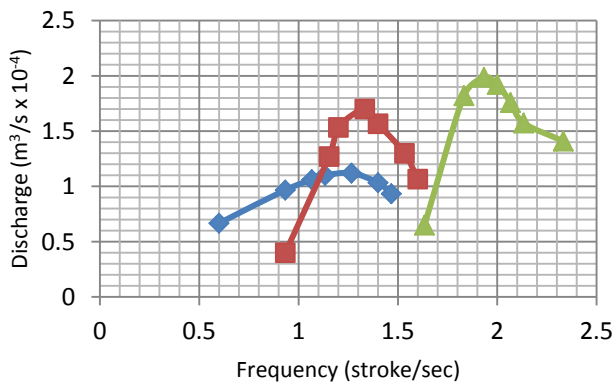

**Fig. 5.** A graph of discharge Q against frequency at different drive Heads

Discharge increase with the frequency of stroke until the optimum mass point then starts to decrease as show in Figure 5. The optimal discharge was found to be  $1.7 \times 10^{-4}$ ,  $1.1 \times 10^{-4}$  and  $0.8 \times 10^{-4} \text{ m}^3/\text{sec}$  and was achieved with the use of 1.40, 1.06 and 0.64Kg weights of the waste valve in the three experiments respectively. A further increase in mass resulted in a decrease in water delivered.

The amount of water delivered increases with an increase in the mass used on the waste valve. This is because a larger mass increases the thrust of water through the delivery valve thus pumping a larger amount of water per unit time as compared to when a smaller mass is used which gives a little thrust thus little quantity of water pumped. The amount of water discharged starts to decrease with further increase of the weights after the optimal discharge point.

## V. CONCLUSION

Different supply heads, delivery heads, stroke frequencies and weights on the waste valve were experimented in order to come up with an optimum size of a hydram pump presented in this study. Performance of the hydram was dependent on the drive head. Optimum weights for maximum discharge were noted at the maximum frequency. This type of hydram requires at least a drive head of 0.5 m which is capable of pumping to a head of 4 m. The waste valve and discharge valve are only two moving parts and requires replacement of the rubber in between due to wear and tear. Recycled aluminium alloy used absorbs most of the noise produced in the waste valve and the air chamber unlike hydrams fabricated from steel.

## ACKNOWLEDGEMENT

The authors thank Prof. Nemoto and Prof. Ando in Ashikaga Institute of Technology, for technical and experimental set support. Mr. Muigai and Mr. Nyanjui for casting technology transfer. This work was also supported by JICA through the Bright Project.

## REFERENCES

- [1] AltInbilek, D., Water and Hydropower For Sustainable Development. International Symposium; Water For Development World Wide, 2005, pp. 104-114.
- [2] GTZ Germany, International Fuel Prices 2007 (5th Edition), Frankfurt, 2007
- [3] Iversen HW, Analysis of the Hydraulic Ram, - journal of fluid Engineering, Transactions of the American society of Mechanical Engineers - 1975
- [4] William Callister, JR, Fundamentals of Materials science and Engineering, New York, John Wiley and sons, inc. chapter 14, page S-119 to S-125.
- [5] Robert L Daugherty , A. B, M. E ,Fluid mechanics with engineering application 8<sup>th</sup> Edition, New York St Louis San Francisco Auckland Bogota Hamburg.
- [6] Robert W. Fox Alan T. Mc Donald, Introduction to Fluid Mechanics 3<sup>rd</sup> Edition published in 1996 by the United Educational, Scientific and Cultural organization.
- [7] Gregory D. Jennings, PhD, PE, Hydraulic Ram pump [http://en.wikipedia.org/wiki/Hydraulic\\_ram](http://en.wikipedia.org/wiki/Hydraulic_ram).

# A Review of Unit Commitment in Deregulated Electricity Markets

Adline K. Bikeri, Christopher M. Muriithi, and Peter K. Kihato

**Abstract**— As electricity markets undergo deregulation all over the world, the approach to the unit commitment problem (UCP) changes significantly. The independent system operator (ISO) relies on bid prices from the various generation companies (GENCOs) to make commitment decisions – a situation that is significantly different from the traditional regulated environment. Each GENCO sets up their own independent unit commitment strategies with the aim of maximizing profit based on the cost characteristics of their generators and revenues from predicted prices of energy and reserve in what is known as the Profit Based Unit Commitment (PBUC). This paper reviews the state of the art in the solution of the PBUC problem in deregulated environments. Various solution methodologies available in literature are discussed and some of the research needs on the topic are highlighted.

**Keywords**— Deregulated Electricity Markets, Independent System Operator, Generation Companies, Profit Based Unit Commitment.

## I. INTRODUCTION

OVER the last two decades or so, there have been significant changes in the operation of electric power systems. One of the main changes has been the restructuring or deregulation of many power systems especially in the developed world; though aspects of deregulation are also beginning to take root in developing nations. Deregulation is the unbundling of vertically integrated power systems into generation (GENCOs), transmission (TRANSCOs) and distribution (DISCOs) companies [1]. The main aim of deregulation is to create competition among GENCOs and hence provide different choices of generation options at lower prices to consumers [2]. With deregulation, one of the main differences is the approach to what is known as the Unit Commitment Problem (UCP).

Traditionally, the UCP is defined as a constrained optimization problem in which optimal turn-on and turn-off schedules for a group of power generation units under some operational constraints are determined over a given time horizon [3], [4]. The objective is to minimize the power generation costs while meeting the hourly forecasted power

demands. The generation costs include fuel, startup, shutdown, and no-load costs. Constraints include capacity reserve, minimum up/down time, maximum power flow in the transmission lines and operating limits etc. In simple terms, the solution of the UCP is the process of deciding when and which generating units at each power station to start-up and shut-down.

In the deregulated environment, generation units are not owned by a single company. There are a number of GENCOs who bid for a share of the market through an Independent System Operator (ISO). The ISO relies on the bid prices to determine which units to use at what time. Individual GENCOs therefore have to determine a schedule for their generators with the main aim of maximizing their profits in the competitive electricity market. In this sense, the UCP has been coined slightly differently as the Profit Based Unit Commitment (PBUC) problem [2]. Over the past fifteen years or so, there has been extensive research on the topic of the PBUC problem with most papers focusing on the solution methodology as this is the main challenge for what can be described as a very complex optimization problem.

This paper summarizes recent work on the profit based unit commitment problem with a main focus on the proposed solution methodologies for deregulated electricity markets. It also highlights the main research needs in this area as the electric energy sub-sector moves towards the promising future of competition in service delivery.

## II. BACKGROUND

From the GENCOs point of view, an optimal solution to the PBUC problem is very important because of the potential economic consequences. Reducing the fuel cost by as little as 0.5 percent can result in savings of millions of dollars per year for large GENCOs which would translate to significant gains in profit [5]. However, the UCP is a mixed combinatorial and continuous optimization problem, which is very complex to solve because of its enormous dimension, a non-linear objective function, and a large number of constraints [6]. Solution methodologies for the traditional UC problem can be found in [3]–[10].

In the deregulated environment, an efficient solution methodology is key to the success of the operations of an individual GENCO. Numerous methodologies for solving the PBUC problem have been proposed in literature. These methodologies can be classified as *classical methods* and

A. K. Bikeri, Department of Electrical and Electronic Engineering, JKUAT (corresponding author. phone: +254 726156716; e-mail: adlinebikeri@gmail.com).

C. M. Muriithi, Department of Electrical and Power Engineering, TUK (e-mail: cmmainamuriithi@gmail.com).

P. K. Kihato, Department of Electrical and Electronic Engineering, JKUAT (e-mail: pkihato@jkuat.ac.ke).

*non-classical methods.* Classical methods include Priority Listing (PL), Dynamic Programming (DP), Branch and Bound, Mixed Integer Programming (MIP), and Lagrangian Relaxation (LR) [10]–[15]. Non-classical methods include Genetic Algorithm (GA), Memetic Algorithm, Ant colony optimization (ACO), Particle swarm optimization (PSO), Artificial bee colony (ABC), Imperialistic competitive algorithm (ICA), Muller method among others [16]–[25]. There have also been proposals for hybridization of some of these methods taking advantage of the strengths of two or more methods to provide a more effective solution algorithm [26]–[33].

One of the biggest needs for GENCOs in deregulated markets is an effective tool for making unit commitment decisions and developing bidding strategies [5]. Firstly, such a tool should be able to accurately capture the dynamic environment that is the competitive electricity market. This includes the incorporation of decisions from competitors which significantly affects market prices and eventually GENCO profits. Secondly, different countries have deregulated to different levels and hence the market characteristics will not be similar. A proposed tool should be flexible enough to capture these differences. The tool should also be able to handle the increased complexity brought about by factors such as uncertainties in electricity prices. Incorporation of non-classical solution methodologies for better solution quality is therefore vital. Finally, the tool should also be able to incorporate system wide policy decisions that affect GENCO operations such as emission constraints and price caps where applicable.

### III. PROBLEM FORMULATION

The Profit Based Unit Commitment problem in deregulated power systems determines the generating unit schedules for maximizing the profit of GENCOs subject to operational constraints such as load demand, spinning reserve and ramp rate limits. Profit ( $PF$ ) is defined as the difference between revenue ( $RV$ ) obtained from sale of energy and in some cases reserve; minus the total operating cost ( $TC$ ) of the GENCO. The objective function of the PBUC problem is given as [13]:

$$\text{Maximize } PF = RV - TC \quad (1)$$

The GENCO revenue comes from selling power to the both the energy and reserve markets. Revenue from the energy market depends on the spot power price while revenue from the reserve market depends on the method of paying for reserve in the particular market. In literature, three strategies for reserve payments have been suggested viz., payment for power delivered, payment for reserve allocated and price process for reserve power. Generally, the reserve price will be higher than the spot price and could significantly affect commitment decisions and overall bidding strategies.

The objective function given in (1) is formulated subject to the following constraints.

1. *Power Balance Constraints:* In PBUC, power generation by a single GENCO may be less than the demand and reserve at a given time. This is because a number of GENCOs are available to serve the system load and a single generator may not be able to meet the load anyway. This is fundamentally different from the “generation equals demand” constraint of the traditional UC problem. The relaxed power balance constraint allows for more flexibility in the unit commitment schedule [17].

2. *Unit Generation Limits:* Generation units usually have operational maximum and minimum power output limits within which the unit output must be maintained.

3. *Minimum Up/Down Time Constraints:* A thermal unit can only undergo gradual temperature changes. Hence, there is a minimum up-time once the unit is running and; for a de-committed unit, a minimum down time before it can be recommitted.

4. *Ramp Rate Limits:* The ramp rate limits confine the power output increase or decrease between adjacent hours for certain units.

5. *Crew Constraints:* To cater for limitations in the number of operational personnel, restrictions on the number of units to be turned ON at the same time may be included.

## IV. SOLUTION METHODOLOGIES

### A. Classical Methods

Falling under the category of classical methods for solving the PBUC problem are Priority Listing (PL), Dynamic Programming (DP), Branch and Bound (B&B), Mixed Integer Programming (MIP), and Lagrangian Relaxation (LR). In the PL method, plants are activated according to a pre-prepared list while schedules are adapted to respect technical restrictions such as minimum up and down times, and minimum and maximum operating points [11]. The PL method is a simple, almost rule of thumb method but the quality of solution is rather rough [1]. In fact using PL almost never results in an optimal solution. Reference [12] gives an Improved Pre-prepared Power Demand (IPPD) table for solving the PBUC problem in a deregulated environment. The method, quite similar to the traditional PL method gives a reasonable qualitative solution with significantly less computation time.

Dynamic programming (DP) is one of the earliest optimization based techniques to be applied to the UC problem and is still used extensively all over the world especially in regulated markets [7]. The DP technique employs a systematic searching algorithm that tries to achieve an optimal solution without having to access all possible combinations. Generating units are classified into related groups from which the optimal path is searched with a reduced number of possible combinations as a result of the classification. The method however suffers from the problem of huge computational time as the number of units being considered grows and hence for large systems with hundreds of units, DP as a solution algorithm for the PBUC problem becomes impractical. In [13], a DP approach is used to obtain a near-optimal unit

commitment in a competitive power market. More significantly though, the problem formulation is incorporated into a Multi-area unit commitment with import/export and tie-line constraints. The method therefore illustrates the process of maximization of GENCO profit in a multi-area system.

Reference [14] uses the classical MILP to solve the PBUC problem. The main contribution of the paper is however not the solution methodology but rather a quantification of the sub-optimality of profit that can be expected in a Price Based Unit Commitment (PBUC) when incorrect price forecasts are used. The results show how crucial an accurate price forecasting regime is for the realization of expected profits. In [15], the MIP and LR methods are compared and the authors note that though the MIP method produces more optimal results, the computation time and memory requirements would be a major obstacle when applying MIP to large UC problems.

Lagrangian Relaxation (LR) is one of the most popular of the classical methods. The main advantage of the method is the speed with which the algorithm converges to a solution [15]. It has however been pointed out that the method suffers from often being stuck at local optima. This is because the quality of the solution strongly depends on the algorithm used to update the Lagrangian multipliers. For this reason, a number of the more recent papers combine LR with one or more of the non-classical methods so as to improve the quality of the solution [31]–[33].

### *B. Non-classical Methods*

Non-classical methods for solving the PBUC problem include Genetic Algorithm (GA), Particle Swarm Optimization (PSO), Muller Method, Shuffled Frog Leaping Algorithm (SFLA), Imperialistic Competitive Algorithm (ICA), Ant Colony Optimization (ACO), Artificial Bee Colony (ABC), Simulated Annealing (SA), Tabu Search (TS), among others. These heuristic algorithms have the advantage that they do not require derivative information to solve the optimization problem [18]. It is actually possible to encode the variables so that the optimization is done with the encoded variables with little attention to the systematic movement towards an optimal solution. The second major advantage is that these methods are better capable of searching through the entire solution space for the global optimal solution. Because of these advantages, they are more capable of dealing with the complex nonlinear constraints related to the PBUC problem and thus heuristic methods have received much more attention from researchers over the last few years.

Reference [16] uses genetic algorithms to solve the PBUC problem. The authors show the improved solution quality of the GA method compared to classical methods. The algorithm is tested with the two interconnected regions of the National Electricity Market in Australia and hence illustrates the practicality on an actual power market. An earlier example of the implementation of GA to solve the PBUC problem is given in [17].

In [18], an improved discrete binary particle swarm optimization (PSO) and a standard value PSO are used

iteratively to solve the PBUC problem. The effectiveness of the solution methodology is illustrated for a GENCO with ten units in a competitive market. The PSO technique is also used to solve the GENCOs PBUC problem in a day ahead competitive electricity market in [19]. Apart from the traditional PSO technique, the authors also test three other PSO techniques: Chaotic PSO (CPSO), New PSO (NPSO) and Dispersed PSO (DPSO) and compare the results. Generation, spinning reserve, non-spinning reserve, and system constraints are considered in proposed formulation. To tackle the problem of long computation time that is usually associated with heuristic methods, [20] proposes a Parallel Particle Swarm Optimization (PPSO) solution to the PBUC problem. The method uses a cluster of computers performing parallel operations in a distributed environment and the results show the effectiveness of parallel computing in handling the huge dimensions of the PBUC problem. The authors report significant reductions in algorithm computation time. The time complexity and the solution quality with respect to the number of processors in the cluster are also investigated.

The Muller method is used for solving the PBUC problem in [21]. The methodology is implemented in two stages. Initially, the determination of units to be committed is obtained by a simple approach and then a non-linear programming sub problem of economic dispatch is solved by the Muller method. The biggest promise with this method is reduced computational time though the initial allocation generally results in a sub-optimal solution.

Reference [22], uses the Shuffled Frog Leaping Algorithm (SFLA) to solve the Profit Based Unit Commitment problem under deregulated environment with emission constraints. The bi-objective function optimization problem is formulated as a maximization of the Generation Companies profit and a minimization of the emission output of the thermal units.

A relatively newer heuristic method known as the Imperialistic Competitive Algorithm (ICA) is used in [23] to solve the PBUC problem in a competitive environment. The algorithm is presented as a tool to be used by GENCOs in making commitment decisions for maximum profit in the day-ahead energy market. The method is validated on a typical 10 generating unit system available in the literature.

The Nodal Ant Colony Optimization (NACO) technique is used in [24] while the Parallel Artificial Bee Colony (PABC) algorithm is used in [25] to solve the PBUC problem. The main contribution of [25] is to illustrate how an effective utilization of computing resources can be used to reduce the time complexity for a large scale power system. A message passing interface based technique is used in the PABC algorithm in distributed and shared memory models to implement the algorithm.

The main challenge with heuristic methods is that the computation process is usually rather time consuming especially as the number of generating units increases. However, these algorithms can be easily implemented in high-speed parallel computing techniques with which the challenge of long computational time can be overcome [20],

[25].

### C. Hybrid Methods

The classical, gradient based search algorithms tend to be faster in convergence but suffer from getting stuck in local optima. The non-classical heuristic methods on the other hand are better at searching through the solution space but are more time consuming. Because of these characteristics a number of researchers have proposed hybrid methods which combine two or more of the above techniques for better solution quality in terms of computation time and solution quality.

Reference [26] was one of the first papers on hybrid methods for the PBUC problem. The paper presented a hybrid model between Lagrangian relaxation (LR) and genetic algorithm (GA) to solve the unit commitment problem with the GA being used to update the Lagrangian multipliers. Better results than those obtained from traditional unit commitment are reported. Reference [27] proposes a hybrid artificial immune system (AIS) based GA algorithm method to solve the PBUC problem. The authors report that the incorporation of the AIS into the GA algorithm results in increased diversity in the initial strings to ensure that the GA searches the entire problem space hence resulting in better solutions.

In [28] an advanced memetic algorithm based solution methodology for the PBUC problem is presented. The algorithm exhaustively looks onto the traditional memetic algorithm solution methodology and proposes several alterations and adaptations on the initialization, selection, crossover, and mutation so as to fit the unique features of the PBUC problem. Reference [29] presents a hybrid optimization technique based on Memetic Particle Swarm Optimization (MPSO) with Cauchy Mutation (CM) to solve the self-scheduling problem in a competitive electricity market. The MPSO is basically a combination of a local search algorithm with the traditional PSO. CM is used to reduce the diversity in the searching process of the PSO.

A hybrid model between Lagrangian Relaxation (LR) and Quantum inspired Particle Swarm Optimization (QPSO) is used to solve the PBUC problem in [30]. Constraints including load demand, spinning reserve, generation limits and minimum up and down time constraints are included and the method is tested on two different size systems. The authors report higher quality solutions compared to other methods in literature. A second example of the hybrid LR-PSO algorithm can be found in [31]. Again the authors highlight the improvement in solution quality by updating the Lagrangian multipliers using the PSO technique.

Reference [32] uses a hybrid Lagrange Relaxation (LR) - Evolutionary Programming (EP) model to solve the PBUC problem in a deregulated electricity market. Here, significantly, a consideration of the losses in the transmission system is included resulting in higher profits for the GENCO as they supply not only system load but also network losses. A hybrid LR-EP method is also used in [33] with an important consideration of both the power and reserve prices.

## V. RESEARCH NEEDS

A review of the literature on profit based unit commitment in deregulated environments as carried out in this paper reveals that there has been a significant effort over the last 10 to 15 years in trying out various solution methodologies for solving what is a very complex optimization problem. However, a number of research needs still exist as outlined below:

1. Most research considers only energy price in the problem formulation and ignore reserve price. The profit from reserve sales could be significant especially in systems with higher load or generation volatility such as grids with large penetration of wind/solar power. It is important to include payments for reserve in the problem formulation and analyze the effects of various reserve payment regimes on Unit commitment decisions in deregulated markets.
2. Apart from ignoring reserve payments, most work is done with a pre-assumed energy spot market price. The electricity spot market usually has volatilities which should be considered in the solution of the unit commitment problem.
3. An assumption of a perfect electricity market dominates the reviewed papers. It is known that most electricity markets are still dominated by one or two major generation companies (usually the offshoot of the previous utility) and hence these markets take an oligopolistic structure. Market power will have a significant effect on decision making hence it is important that the market model used captures these characteristics.
4. There is also usually no inclusion of other system policy decisions such as environmental considerations which could alter commitment decisions. There is need to carry out an analysis of the effects of such policies on GENCO profits and consequently recommend any changes that would be required in the adopted unit commitment regime as a result of such policies.

## VI. CONCLUSION

This paper gives an overview of the profit based unit commitment problem in deregulated electricity markets. Recent literature on the topic is reviewed which reveals significant efforts have been placed on finding better solution methodologies for the optimization problem. These methodologies range from the classical gradient based methods to the newer heuristic type methods and also hybrids of these methodologies. A number of research gaps have been identified. These mainly include need to include all aspects of the practical market place including reserve payments, spot market price volatility, imperfect complete environment and environmental considerations in the problem formulation.

## REFERENCES

- [1] A.J. Wood, B.F. Wollenberg, and G.B. Sheble, *Power Generation Operation and Control*, 3rd ed., New Jersey: John Wiley & Sons, Inc., 2013, pp 42-57.
- [2] M. Shahidehpour and M. Alomoush. *Restructured Electrical Power Systems, Operation, Trading, and Volatility*, 1st ed., New York, Marcel Dekker, 2000, pp. 1-11.

- [3] W.L. Snyder, H.D. Powell, and J.C. Rayburn, "Dynamic programming approach to unit commitment," *IEEE Trans. Power Systems*, vol. 2, no. 2, pp. 339-348, May 1987.
- [4] V. Sudhir, E.C. Adrian, K. Imhof, and M. Shishir, "Implementation of a Lagrangian based unit commitment problem," *IEEE Trans. Power Systems*, vol. 4, no. 4, pp. 1373-1380, Nov. 1989.
- [5] N.P. Padhy, "Unit commitment problem under deregulated environment – A Review," *Power Engineering Society General Meeting*, vol. 2, pp. 1088-1094, July 2003.
- [6] N. P. Padhy, "Unit commitment – a bibliographical survey," *IEEE Trans. Power Systems*, vol. 19 (2), pp. 1196-1205, May 2004.
- [7] P.G. Lowery, "Generating unit commitment by dynamic programming," *IEEE Trans. Power Apparatus and Systems*, vol. PAS-85, no.5, pp.422-426, May 1996.
- [8] C.P. Cheng, C.W. Liu, and C.C. Liu, "Unit commitment by Lagrangian relaxation and genetic algorithm," *IEEE Trans. Power System*, vol. 15, no. 2, pp. 707-714, May 2000.
- [9] M.C. Arroyo and M. Jose, "A computationally efficient mixed-integer linear formulation for the thermal unit commitment problem," *IEEE Trans. Power System*, vol. 21, no. 3, pp. 1371-348, May 2000.
- [10] I. G. Damousis, A. G. Bakirtzis, and P. S. Dokopoulos, "A solution to the unit commitment problem using integer-coded genetic algorithm," *IEEE Trans. Power Systems*, vol. 19, no. 2, pp. 1165-1172, May 2004.
- [11] E. Delarue, D. Cattrysse, and W. D'haeseleer, "Enhanced priority list unit commitment method for power systems with a high share of renewables," *Electric Power Systems Research*, vol. 105, pp. 115-123, Dec. 2013.
- [12] K. Chandram, N. Subrahmanyam, and M. Sydulu. "Improved Pre-prepared Power Demand Table and Muller's Method to Solve the Profit Based Unit Commitment Problem," *J. of Electrical Engineering & Technology*, vol. 4, no. 2, pp. 159-167, June 2009.
- [13] A. Rajan, C. Christober, P. Sundarajan, V. Jamuna, R. Madhusubash, and B. Udayakumar, "Multi-Area Unit Commitment in Deregulated Electricity Market using DP Approach," *Inter. J. Recent Trends in Engineering & Technology*, vol. 3, no. 3, pp 210- 213, May2010.
- [14] E. Delarue, P. van Den Bosch, W. D'haeseleer, "Effect of the accuracy of price forecasting on profit in a Price Based Unit Commitment," *Electric Power Systems Research*, vol. 80, no. 10, pp. 1306-1313, Oct. 2010.
- [15] T. Li and M. Shahidehpour, "Price-Based Unit Commitment: A Case of Lagrangian Relaxation versus Mixed Integer Programming," *IEEE Trans. Power Systems*, vol. 20, no. 4, pp. 2015-2025, Nov. 2005.
- [16] C.A. Baloi, J.A. Belward, and M. Bulmer, "Genetic unit commitment model in a deregulated power energy environment," in *Proc. International congress on modelling and simulation*, Townsville, Australia, 2003, pp. 1078-1083.
- [17] C.W. Richter Jr, and G. B. Sheble, "A profit-based unit commitment GA for the competitive environment," *IEEE Trans. Power Systems*, vol. 15, no. 2, pp. 715-721, May 2000.
- [18] Y. Xiaohui, Y. Yanbin, W. Cheng, and Z. Xiaopan, "An Improved PSO Approach for Profit-based Unit Commitment in Electricity Market," presented at the Transmission and Distribution Conference and Exhibition: Asia and Pacific, Dalian, China, 2005 IEEE/PES
- [19] J. Raglend, C. Raghuveer, G. R. Avinash, N.P. Padhy, and D.P. Kothari, "Solution to profit based unit commitment problem using particle swarm optimization," *Applied Soft Computing*, vol 10, no. 4, pp. 1247-1256, Sept. 2010.
- [20] C.C. Columbus and S.P. Simon, "Profit based unit commitment for GENCOs using parallel PSO in a distributed cluster," *ACEEE Int. J. Electrical and Power Engineering*, vol. 2, no. 3, Nov. 2011.
- [21] K. Chandram, N. Subrahmanyam, and M. Sydulu, "New approach with Muller method for Profit Based Unit Commitment," in *Proc. Electric Utility Deregulation and Restructuring and Power Technologies*, Nanjing, China, 2008, pp. 952-957.
- [22] T. Venkatesana, M.Y. Sanavullahb, "SFLA approach to solve PBUc problem with emission limitation," *International Journal of Electrical Power & Energy Systems*, vol. 46, pp. 1-9, March 2013.
- [23] M.J. Ghadi, and A. Baghrmian, "A New Heuristic Method for Solving Unit Commitment Problem in Competitive Environment," *International Journal of Soft Computing and Engineering*, vol. 2, no. 6, pp. 2231-2307, Jan. 2013
- [24] C.C. Columbus, K. Chandrasekaran, and S.P. Simon, "Nodal ant colony optimization for solving profit based unit commitment problem for GENCOs," *Applied Soft Computing*, vol. 12, no. 1, pp. 145-160, Jan. 2012.
- [25] C.C. Columbus and S.P. Simon, "Profit based unit commitment: A parallel ABC approach using a workstation cluster," *Computers & Electrical Engineering*, vol. 38, no. 3, pp. 724-745, May. 2012.
- [26] H. Y. Yamin and S. M. Shahidehpour, "Unit commitment using a hybrid model between Lagrangian relaxation and genetic algorithm in competitive electricity markets," *Electric Power Systems Research*, vol. 68, no. 2, pp. 83-92, Feb. 2003.
- [27] K. Lakshmi and S. Vasantharathna, "Hybrid Artificial Immune System Approach for Profit Based Unit Commitment Problem," *J. Electrical Eng. Technology*, vol. 8, no. 1, pp. 742-751, March 2013.
- [28] D.K. Dimitroulas, P.S. Georgilakis, "A new memetic algorithm approach for the price based unit commitment problem," *Applied Energy*, vol 88, no. 12, pp. 4687-4699, Dec. 2011.
- [29] R.B. Muthu, S. Periasamy, "Profit Based Self Scheduling of the Genco's by Using Particle Swarm Optimization," *UPB Scientific Bulletin, Series C: Electrical Engineering*, vol. 74, no. 2, 2012.
- [30] K. Asokan, and R. Ashokkumar, "Emission Controlled Profit based Unit Commitment for GENCOs using MPPD Table with ABC Algorithm under Competitive Environment," *WSEAS Transactions on Systems*, vol. 13, pp. 523-542, 2014.
- [31] D.J. Nahomi and V. Yuvaraju, "A new approach for Profit-Based Unit Commitment Using Lagrangian Relaxation combined with Particle Swarm Optimization algorithm," *Inter. J. Communications and Engineering*, vol. 4, no. 4, pp. 159-166, Mar. 2012.
- [32] S.C. Selvi, M. Moses, C. Rajan, "LR-EP Approach for solving Profit Based Unit Commitment Problem with Losses in Deregulated Markets," *Przeglad Elektrotechniczny*, vol. 11, pp. 210 - 213, 2013.
- [33] P. Attaviriyanupap, H. Kita, E. Tanaka, and J. Hasegawa, "A Hybrid LR-EP for Solving New Profit-Based UC Problem under Competitive Environment," *IEEE Trans. Power Systems*, vol. 18, no. 1, pp. 229-237, Feb. 2003.



# Sustainability Challenges and Opportunities of Generating Biogas from Water Hyacinth in Ndunga Village, Kenya

Antony N. Kamau, Paul Njogu, Robert Kinyua and Mohamed Sessay

**Abstract**— Recent studies show possibilities of producing bio-energy from water hyacinth thus generating avenues for research, technological development and marketing of its energy products. As the search for alternatives to clean energy sources intensifies in this age of industrialization, coupled with the increasing energy costs on conventional energy sources, water hyacinth holds a strong promise in the production of clean renewable energy. Though it possess significant benefits, there is need to understand the viability and sustainability of such a technology through assessment of likely socio-economic and environmental impacts to the local community and environment in general. Thus the study was to determine potential of water hyacinth *E. crassipes* as a suitable source of renewable energy in an effort to pursue alternative approaches in the management of water hyacinth in Lake Victoria. The study was carried out in a small village called Ndunga along Lake Victoria in three phases employing both descriptive and analytical data collection techniques. The study established that indeed the utilization of water hyacinth to yield biogas adds value to the noxious weed, whereas the bi-product slurry can be added in to the soil, as a bio fertilizer, to boost its nutrient composition. Thus contributing to sustainable management of water hyacinth in the lake, whereas bridging present gaps in energy provision for the rural communities living along water hyacinth infested ecosystems. A concept of waste to wealth in enhancing sustainable development.

**Keywords**— Biogas, Lake Victoria, Water Hyacinth.

## I. INTRODUCTION

### A. Background

Water Hyacinth is a free- floating flowering weed whose origin is in South America. It is an aquatic freshwater plant biologically known as *E. crassipes*, belonging to the family Pontederiaceae, related to the lily family (Liliaceae) which reproduces both asexually through stolens and sexually by seed propagation, and remains viable for up to 20 years making it difficult to control [8]. In aquatic systems, water hyacinth is normally distributed by water currents, wind and boats among others agents. It was first introduced as an ornamental crop species in many countries more than a century ago, and later realized to be an invasive species due to its adaptability to a wide range of fresh water ecosystems

A. Kamau, Institute of Environment and Energy Technology, JKUAT  
(corresponding author: e-mail: antonyndegwa.k@gmail.com).

causing interference to human activities and adversely affecting flora and fauna making it to be considered as a noxious weed in many parts of the world that significantly endanger the livelihoods of millions of poor people in the tropics.. Also, the invasion of water hyacinth in water ways is reported to cause challenges in hydro-electric generation, irrigation and as well as increased in water loss in aquatic systems through evapo-transpiration. The weed provides breeding grounds for schistosome (bilharzia)-carrying snails and malaria-carrying mosquitoes. In Lake Victoria for example, the infestation currently covers 12,000 ha and is affecting the livelihoods of more than 40 million people in Kenya, Tanzania and Uganda [8].

By the end of 1997, media agencies reported a 70% decline in economic activities at the Kenyan port of Kisumu as a result of the water hyacinth choking the port and fish landing grounds [7]. As a result huge amount of money and efforts have been invested, since its introduction, to manage its growth with world leading environment conservation institutions like the World Conservation Council (IUCN), the United Nations Environment Program (UNEP), and the Ramsar Convention on Wetlands classifying water hyacinth as the world's most destructive plant species, costing billions of dollars in damages each year.

### B. Presence in Africa

In the developing world, it has been used in traditional medicine and even used to remove toxic elements from polluted water bodies [8]. Due to its ability to grow very fast and depleting nutrients and oxygen rapidly from water bodies, adversely affecting flora and fauna, it has been considered as a noxious weed in many parts of the world and significantly endangering the livelihoods of millions of poor people in the tropics. The influx of water hyacinth has resulted in serious socioeconomic and environmental problems for millions of people in riparian communities. Normally, the weed proliferates to form extensive floating mats that cause complete blockage of waterways making fishing and other water related human activities such as recreation and navigation very difficult. Also invasion of water ways by water hyacinth is reported to cause challenges in hydro-electric generation, irrigation and as well as increased in water loss in aquatic systems through evapo-transpiration. The weed also provides breeding grounds for schistosome (bilharzia)-carrying snails and malaria-carrying mosquitoes. The cost of water hyacinth infestation for countries in the region is

estimated to be of the order of billions of dollars. For example, in Lake Victoria, the infestation currently covers 12,000 ha and is affecting the livelihoods of more than 40 million people in Kenya, Tanzania and Uganda [8]. By the end of 1997, media agencies reported a 70% decline in economic activities at the Kenyan port of Kisumu as a result of the water hyacinth choking the port and fish landing grounds [7].

According to [24] report, it is indicated that under favorable conditions water hyacinth can achieve a growth rate of 17.5 metric tons per hectare per day. World leading environment conservation entities like the World Conservation Council (IUCN), the United Nations Environment Program (UNEP), and the Ramsar Convention on Wetlands have classified water hyacinth as the world's most destructive plant species, costing billions of dollars in damages each year.

In Kenya, although water hyacinth is known to have been kept in Nairobi and Mombasa as an ornamental plant since early 1957, it appeared in the natural water systems of Lake Victoria in the late 1980s [11]. Lake Victoria has a surface area of 68,800 Km<sup>2</sup> and an adjoining catchment of 184,000 Km<sup>2</sup>, and is the world's second largest body of fresh water, second only to Lake Superior [11]. The lake touches the equator in its northern reach enclosing innumerable small, shallow bays and inlets, many of which include swamps and wetlands which differ a great deal from one another and from the off-shore environment of the lake. Kenya, Tanzania and Uganda control 6, 49, and 45%, of the lake surface [7] respectively. The gross annual economic product from the lake catchment is in the order of US\$3–4 billion, supporting an estimated population of 25 million at per capita annual incomes in the range US\$90–270 [8]. Thus providing for the livelihood of about one third of the combined populations of the three countries, and about the same proportion of the combined gross domestic product. Economically, the lake catchment is principally fishing with substantial subsistence agricultural activities. In Kenya and Uganda, the areas of coffee and tea in the lake's catchment are a significant part of those nations' major agricultural exports.

The lake is also seen as a source of food, energy, drinking and irrigation water, transport, and as a repository for human, agricultural and industrial waste. The population around the riparian communities has been noted to grow fast, leading to increased resource use and conflict around the Lake Basin rendering the lake as environmentally unstable. The lake ecosystem has undergone substantial changes which have accelerated the dominance by the toxic blue–green algae [25]. The frequency of water-borne diseases has increased. Water hyacinth has choked important waterways and landings [25]. Massive depletion of oxygen in the deeper waters of the lake threatens the artisanal fisheries and biodiversity. Scientists advance two main hypothesis for these extensive changes. First, the introduction of Nile Perch as an exotic species some 30 years ago has altered the food web structure. The second hypothesis is that nutrient inputs from its catchment are causing eutrophication, creating favorable conditions for proliferation of Water hyacinth. Thus, although the lake and its fishery have shown evidence of dramatic changes in the

past three decades, the problems have arisen mainly as a result of human activities in the lake basin. Efforts among various actors have been put in place all over Africa to remove water hyacinth from waterways. This is been done by hand, by machine, using chemical pesticides and biological control methods. Though great efforts and resources have been directed towards its complete eradication continues to be elusive with discrepancies among policy makers, environmental agencies and research scientists on the best way to control this invasive species and the practical benefits that can be obtained. The Convention on Biological Diversity recommends that each contracting party take measures to prevent the introduction of exotic species and to control or to eradicate those that threaten ecosystems, habitats or species. Hence concerns over introduction of other sustainable control measures continue to be explored, forming the rationale to this study. Achieving solutions to possible shortage in fossil fuels and environmental problems that the world is facing today requires long-term potential actions for sustainable development. In this context, renewable energy resources appear to be one of the most efficient and effective solutions.

#### *C. Potential of Water Hyacinth for production of renewable energy*

In efforts to manage water hyacinth, recent studies, [5], report possibilities of producing energy (bio-fuels) from the water hyacinth. This has generated ample avenues of research, development and marketing of the hyacinth's energy products. As the search for alternatives to clean energy sources intensifies in this age of modernization and industrialization, fuelled by increasing energy costs and needs, water hyacinth holds a strong promise in the 21<sup>st</sup> century. In Kenya for example, growth in the industrial sector accounts for more energy requirement, hence the need to generate more energy at a lower cost to support the energy needs of the marginalized groups and rural communities who play a big role in the growth of an economy. Currently, Kenya's major source of energy for commercial use is petroleum and electricity, while wood fuel and charcoal provides energy needs for majority of rural communities and the urban poor. According to Vision 2030, the government remains committed to continued institutional reforms encouraging innovation in the energy sector (Kenya Vision, 2030). It is in that perspective that efforts by various actors in the energy sector in Kenya and around the world, have been intensified research to generate biogas using water hyacinth. For example, currently a partnership between Jomo Kenyatta University of Agriculture and Technology through its Institute of Energy and Environmental Technology and Japan International Cooperation Agency has set up a prototype facility at Ndunga beach to assess biogas production technology using water hyacinth with the objective of scaling up renewable energy production for rural development through the 'Bright Project'. As concerns over introduction of other sustainable control measures to the water hyacinth menace, the emergence of this technology that seeks to use water hyacinth for biogas production is not only seen as a

breakthrough in clean energy revolution but also a significant measure in the control of the invasive species in fresh water ecosystems. A technology that upholds the concept of waste to wealth in enhancing sustainable development.

This study hypothesized that biogas production using water hyacinth enhances sustained management of water hyacinth in Lake Victoria and promotes socio economic activities for the community living in Ndunga beach in the lake region.

#### *D. Study Objective*

The study seek to identify the social, economic and environmental impacts of utilizing water hyacinth as feedstock for biogas production in Ndunga, to determine the viability and sustainability of this technology.

#### *E. Study Questions*

In doing so, the study focused on answering 3 key research questions notably:

1. How has water hyacinth affected the livelihoods of the community in Ndunga beach?
2. Does water hyacinth hold significant value as a source of renewable energy to address energy gaps in Dunga and to warrant adoption of the technology by the community?
3. How environmentally sustainable is this technological development?

## II. METHODOLOGY

A preliminary study of Ndunga village was carried out to map out all stakeholders relevant to this study leading to the identification of study respondents. The study focused on the locals, the business community, government as well as the non-governmental organizations whose activities revolved around the lake management. Among the respondents identified were local community members who included fishermen, farmers, small enterprise owners, employees of government bodies operating in the region as well as officials of non-governmental organizations operating in the area; all of whose activities have been affected by water hyacinth infestation of the lake in one way or another. A total of 50 respondents, an estimate of 16% of Ndunga's population, were interviewed, with a response rate of 96% of the respondents.

Stratified random sampling procedure was then used to identify sample respondent. Data was collected using questionnaires administered through interviews schedules. Focus group discussions were also held to collect data that would otherwise not be captured from individual interviews. This technique was helpful in profiling social, economic and environmental issues related to water hyacinth invasion of the lake, obtain information on potential risk factors and benefits associated with this technological development in water hyacinth management and renewable energy development. The choice of data collection method to specific respondents was based on how best the respondent was able to provide information effectively and conveniently. Desktop review of relevant literature was done to acquire information on benefits

of similar technologies applied elsewhere in rural setups world.

Satellite images were also acquired to show hyacinth spatial distribution and the dynamic of water hyacinth over a specific period of time. The study emphasised on cost-benefit relationship analysis of the findings as the overarching factor in determining the viability and sustainability of this technological development. Thus qualitative and quantitative data analysis methods were employed in the study. Frequency distribution tables and measures of central tendency (mean), measures of variability (standard deviation) were used to generate logical information from collected data. The analysis was aided by the use of SPSS software, which produced the various statistical results. Tables, charts and other diagrammatic representation of data were used to present the data, summarize responses for further analysis and interpretation of findings as well as facilitate comparison of various variables.

## III. RESULTS AND DISCUSSIONS

### *A. Study Site Characteristics*

Located on the eastern side of Kisumu, Dunga beach exhibits a set of unique characteristics that determines its identity and the behaviour of its people. Physically, the beach forms a gulf that borders Lake Victoria from the eastern side of Kisumu. This largely influences fishing as the main economic activity and source of livelihood for majority of the community members. Also, as an enclosed community with only one exist route, Dunga community still upholds traditional practises common among the Luo community making it a distinct site for social studies. It is in this regard that many researchers have in the past used Dunga community for various social related studies. Close proximity to the lake gives Dunga ease access to the lake which has contributed to increased ecotourism activities, and related studies in the region. However, Dunga faces a myriad of challenges with regards to the level of development compared to neighbouring communities due to limited resource allocation. As the study established, majority of the community do not feel the government's presence neither enjoy any government incentives. In fact, according to Kisumu district data on resource distribution and expenditure, (2009), this region received the least amount of funding for development purposes, of which no physical evidence of development initiatives could be accounted for.

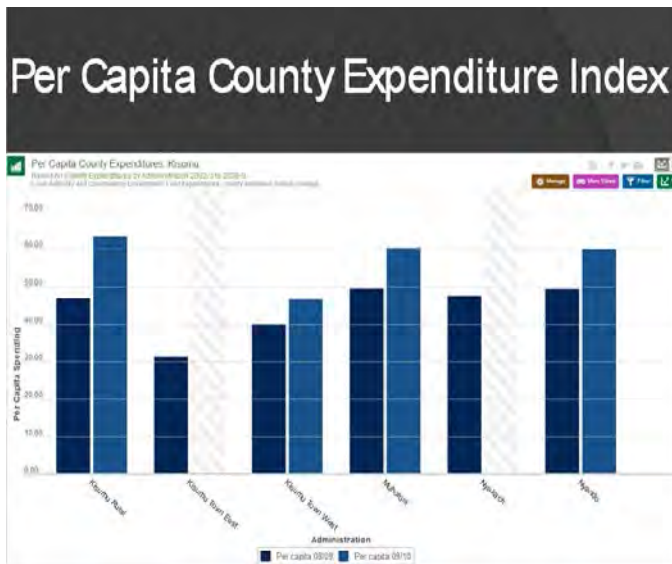

Fig. 1:2008/2010 Kisumu County Expenditure Index Per Region)

This has resulted to marginalization of the local community characterised by the significant level of illiteracy of the local population, limited access to social amenities, poor housing structures and dire sanitary conditions of the local community, as well as poor access roads. In pursuit for survival, a number of small enterprises, in the form of hotels, general merchandise and workshops have been set up by locals to provide important goods and services for the community. These also contributed to a number of job creation opportunities for a few members of the community. However, with the devolved system of government coming into place communities remained hopeful of better days to come though nothing much had be done by the time this study was undertaken. As a small community, Dunga is estimated to host approximately 300 people with around 50 homesteads spread across the village. This is according to Kisumu county census data of 2009. The study established that the population has over the years significantly reduced due to reduced opportunities for economic activities. This is linked to water hyacinth invasion of the lake given that Dunga is widely known as a fishing community. Luo, an ethnic community that represents a significant third of Kenya's population, dominates Dunga village as the major ethnic group at approximately 99.9% of the population.

### B. Social Economic Status of Dunga community

To understand the socio-economic status of the community, the study focussed on literacy levels, major economic activities practised by the local community and employment opportunities available as key indicators of economic and social wellbeing of Dunga community.

### C. Literacy

Literacy level of the Dunga community was assessed to be significantly low and this is linked to limited access to educational facilities. In fact, of the few education institutions available for the community, they are located outside Dunga

village and are known to be lacking on standard education facilities with inadequate structural facilities for conducive learning environment. This has disadvantaged Dunga community from accessing decent education. The huge distance covered between available schools to Dunga community was seen to hinder access to education for majority of the children. Though school records show high admission numbers of children, the turn up rates were significantly low with a huge numbers of school dropouts been recorded over the years. From the respondents who participated in this study, only 32% had access to some kind of formal education, of who majority were immigrants working for local Non-governmental organizations, government institutions outside Dunga village, or were students at the time the study took place. To understand why classroom turn up was significantly low, the study established that majority of the school going children had responsibilities in fish production process, whereas others were engaged in various house hold chores. Little attention and emphasis by the caregivers and the community in general was given to the importance of children accessing education. The needs for community's survival outweighed the need to access education making it seem a luxury for most community members would not afford to educate their children. This can be linked to the community's failure to initiate alternative means of livelihood to counter reduced economic activities since the introduction of water hyacinth in the lake.

### D. Poverty and Unemployment

More often than not, close relationship exists between the level of literacy of a community and poverty index of the community. Though Dunga has a relatively small population compared to other regions in Kisumu, the number of economic activities and related opportunities for livelihood are minimal. Evidently, little attention from the national and local government to the Dunga community can be attributed to its underdevelopment. Some of the key indicators of underdevelopment in Dunga include limited investment opportunities, limited social amenities and poor infrastructure available for the community. The inequitable distribution of resources has also played a significant role in impoverishment of Dunga community. Limited economic opportunities have left the community to depend on the lake as their major source of livelihood. Proliferation of water hyacinth in the lake continues to aggravate the situation with reduced economic activity in the lake region. This has however led to change in behaviour of local community as members of the community seek ways of coping with distressed economic opportunities. Social vices such as prostitution among women, alcoholism and substance abuse among young adults have been recorded to be on the increase. In a region where crime was very rare, trends show increased cases of petty crimes with theft top on the list. Such behaviour changes have both direct and indirect effects to the wellness of the community and overall management/conservation of the lake ecosystem.

Sources of livelihoods for Dunga community as the study found out are fishing, small scale farming, weaving, employment from local NGOs and government institution operating in the area. A number of small scale enterprises such

as shops and related retail outlets are present in the area to supplying the local population with important goods and services. A small number of Dunga's population depended on formal employment from manufacturing industries, non-for profit organizations and government bodies operating around the lake region, whereas a minority practise different forms of farming for subsistence use.

#### E. Economic Activities common among Ndunga community members

Commonly known as a fishing community, Dunga's economy largely revolves around fishing as the main driver of economy, with fish been used for trade and for subsistence use. According to the study results, 26% of the respondents were dominantly involved with commercial fishing while significant majority of those who said to be in other types of businesses, 18%, partly engaged in fishing activities as either fishmongers or fish transporters. In fact, even for the 6% who practised farming, 12% who practised crafting or depended on employment as their main economic activity, they still depended on fish for nutritional value as their main source of protein.

Respondents who said to be in business were either small business enterprise owners supplying general goods and services to the local population while others were in tourism business as boat riders or crafting/weaving industry. Of the 12% respondents who practised weaving/crafty majority are women and youths, who depend on the readily available raw material for making their products. Water hyacinth takes lead as their main source of raw material, among other plants found in the wetland. The study also found out that unemployment is significantly high with 19% of the respondents not engaged in a regular economic activity, which explains the increase behaviour changes among youths.

However, interesting analysis of the community show that the entire population somehow depended on the lake directly for their livelihood and likewise affecting the lake's ecosystem.

#### F. Social, Economic and Environmental Impacts of Water Hyacinth Proliferation in Ndunga.

The dependence of the community on the lake and its resources as means of livelihood, as established by the study, indicates that approximately everybody living within Ndunga village has either been positively and/or negatively affected by water hyacinth introduction in the lake. Thus making it important for the study to assess and analyse how water hyacinth affects the livelihood of the community along their social and economic activities. The study found out that majority of respondents 54%, who participated in the study were not aware of the source of hyacinth in the lake, and only a few, 16%, held the opinion that hyacinth was introduced by foreigners in the lake, with others 30% thought that it was brought by water currents from the Ugandan side of the lake. It is thus not clear as to the origin of water hyacinth in Lake Victoria, though all respondents acknowledged been aware of its presence in the lake for the past couple years.

Fig. 2 below shows how respondents thought water hyacinth has affected their livelihoods.

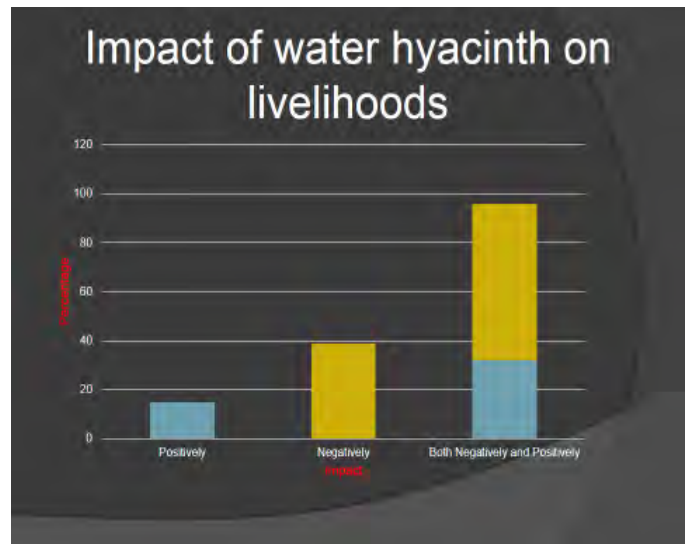

Fig. 2: Impacts of Water Hyacinth on the Livelihoods of Ndunga Community)

Highlighted in yellow indicate respondents, 26% have been exclusively affected by water hyacinth invasion of the lake negatively, while highlighted in blue, 10%, show the percentage of respondents who thought water hyacinth was a blessing in disguise as it had positively affected their livelihoods. However, majority of the respondents, 64%, felt that introduction of water hyacinth in the lake had affected their livelihoods both positively and negatively. Irrespective of the negative impacts associated with water hyacinth invasion of the lake, this indicates that some community members had identified value in the weed for economic gain or otherwise.

#### G. Positive Impacts

First and foremost majority of the youth felt that water hyacinth had increased employment opportunities for they were hired occasionally to remove the weed. Through continuous efforts from various stakeholders to eradicate the weed, many youths had benefited from short term casual employment opportunities to physically remove the weed from the shores of the lake. However, these efforts were not sustainable as the rate of reproduction and spread of water hyacinth in the lake outdoing removal measures. Though this was viewed as a threat to the larger society that depended on the lake, a portion of the society made an income out of it.

The continued loss of traditional methods of livelihoods of Ndunga community from water hyacinth proliferation in the lake has led to the introduction of innovative alternative means of livelihoods. Among these initiatives include introduction of new products from water hyacinth for income generation through sale. Some of these items include; furniture items, mats, cards among others. The introduction of new products from the hyacinth has created increased entrepreneurship opportunities for the community through product development, marketing, sales resulting to improved livelihoods. Among those who have largely benefited from this venture are women and youth.

Water hyacinth has boosted weaving business. The use of reeds for weaving of fish baskets among other items was among other traditional social economic activities practiced by women in the society. Identification of water hyacinth as an alternative source of raw material for weaving has led to increased business cautioning the community from reducing traditional raw material as a result of increased harvesting.

Among the livestock keeping community members, water hyacinth is seen as animal feed during dry periods. Though known as a fishing community, a number of community members in Ndunga and its surrounding have kept livestock to boost their means of household income. Majority of animals kept are goats as they are less tedious to handle, require little feeding and easily adapt to unfavorable environmental conditions. Though the lakeside is characterized by humid climatic conditions, vegetation growth in the region is minimal due to the rocky soils. As evidently acknowledged, harvesting of hyacinth for animal feed is a common practice among villagers who keep animals. Hence water hyacinth has been use as feed for animals.

Whereas some farmers use water hyacinth as feed for their animals, others use it for mulching and to make compost manure for their farms. Among respondents who practiced small scale subsistence farming, they acknowledged using hyacinth to make compost manure to nourish their soils with some using it for mulching.

#### *H. Negative Impacts*

Majority of the respondents indicated that pollution of lake water lists high among other negative impacts water hyacinth has caused to the community. This can be attributed to the significant role the lake has on Dunga community as a source of water for household use, for consumption as well as industrial use. Excessive growth of water hyacinth in the lake brings about eutrophication of lake water making it less suitable for use especially for domestic purposes. This further complicates the social roles given to women and young girls who have to travel long distances to access and fetch water from sections of the lake that seem easily accessible and where water appears cleaner. The study also established that proliferation of water hyacinth in the lake is also significantly attributed to community activities along the lakeshores that lead to pollution of the lake through influx of nutrients in the lake, a condition that creates conducive environment for hyacinth rapid growth.

Reduced fish stock over time recorded second from water pollution as a negative impact of water hyacinth proliferation in the lake. This is as a result of decreased fishing grounds, polluted waters making it unfit for fish consumption, and blocked water ways making movement in water a challenge. Majority of those who indicated reduced fish stock were fishermen due to the nature of their work.

They further pointed out that water hyacinth had led to destruction of their fishing nets raising the cost of doing business with increased investment on fishing nets.

Water hyacinth in the lake creates conducive bleeding environment thus the increased incidents of malaria and bilharzia diseases been recorded over time. Though listed least, at 4% among negative impacts water hyacinth has

brought to the community. Majority of those affected are children, and their families have had to incur huge costs in accessing medical treatment. Cases of mortality of under 5yrs old children from these parasitic diseases have been recorded.

In an underdeveloped community like Ndunga Village, where no appropriate water supply means are present, children and women suffer the burden of fetching water for the household. In Ndunga for example; children continue to play the huge responsibility of fetching water and firewood. The search for water for household use brings with it significant challenges for children, among them being exposure to disease causing organisms, drowning in the lake, and limited study time for school going children.

Other negative impacts brought about by water hyacinth are reduced activities in the lake such as recreation activities like swimming, sports like boat racing, and local tourism as a vibrant economic activity for some members of Ndunga community had also been hard hit by water hyacinth invasion of the lake.

The increased cost of fishing has not only affected the fishermen but has also pushed the cost impact to the consumer who now has to dig deeper into the pocket to part with much more than usual. This has directly and indirectly affected the behavior of some community members as they seek to cope with the increasing cost of survival. Cases of young women engaging in prostitution in exchange fish to feed their families have been reported to be on the rise. Crimes such as petty robbery by young men have also been reported to be on the increase. Intake of illicit brews and related substance abuse by vulnerably idle men, women and youths is evidently present within Dunga community.

#### *I. Impacts on the Environment*

As established by the study, there are a number of impacts on the environment and to the lake's ecosystem that are linked to water hyacinth. Among them are;

**Physical Impacts-** Since its introduction in the lake, according to the community, the volume of water in the lake has continued to reduce significantly and this is characterised by increasing size of the shorelines, as well as decreased water access points especially during periods of intense cover of the lake water by the hyacinth. Other physical changes to the lake water as highlighted by the respondents include change in water colour due to eutrophication, reduction of water temperatures as a result of blocked sun rays from reaching water surface, blocked water ways leading to reduced water movement through currents, and this has potential to reduce the amount of oxygen diffused in the lake water, reduced accessibility and movement in the lake.

**Biological Impacts-** Though plants are known to be important medium for oxygen-carbon dioxide exchange in aquatic ecosystems, the presence of high mass of water hyacinth in the lake is likely to result in the significant reduction of dissolved oxygen in the water, thus affecting the ability of the lake to support the life of delicate living organisms such as fish. Reduction in dissolved oxygen in the lake can also arise from decomposition of dead organic matter of the hyacinth in the lake due to aerobic processes of decomposition. This alongside increased turbidity of the lake water resulting to

reduced oxygen ion exchange in the lake can be attributed to reduced population of certain species of living organisms in the lake. This further alters the food chain, and livelihood of communities that depend on the lake for as a source of food. As such, the study established that water hyacinth plays a significant role in the biological oxygen deficiency of the lake water and thus affects life of aquatic organisms in the lake.

Chemical Impacts- Unmanaged disposal of water hyacinth, from physically removed in the lake, on the land surface is of concern to the community according to the study respondents. This is because of the foul smell caused by the decaying hyacinth resulting to irritation and discomfort to the local population. During decomposition of water hyacinth, various chemical reactions are likely to take place with exposure to sunlight resulting to the release of methane into the atmosphere.



Since methane is a known significant greenhouse gas, the study determined that continued release of methane to the atmosphere through such processes is likely to contribute to climate change.

Well known for its ability to absorb metal components from the water, disposal of harvested water hyacinth on the land surface is likely to contribute to the transfer and release of heavy and trace metals and related nutrients on lands surfaces which could result to further leaching of the respective metals and nutrients to ground water.

Whether introduction of water hyacinth has affected the negatively or positive, the use of water hyacinth

Whereas water hyacinth invasion of the lake has generated huge attention over its negative impacts, the study went ahead to determine how the community is coping, both at individual and institutional level. As the study found out, a number of localised institutional and community led interventions have been put in place to control the spread of water hyacinth whereas other to caution the local population from the negative effects of water hyacinth proliferation in the lake.

#### J. Bio-Energy production using Water Hyacinth

However, with recent studies indicating that water hyacinth holds significant potential as a feedstock for biogas production, the continued presence of water hyacinth in Lake Victoria holds a strong promise in the production of localized renewable clean energy for Ndunga community complementing the current conventional non-renewable energy sources for cooking and lighting; hence the importance of understanding the viability and sustainability of this technology. As such the study focused on availability of raw materials, energy gaps of Ndunga community, community perception in regards to adoption of the new technology, and disposal of slurry residual generated from the biogas digester vis a vis its impact to the environment.

#### K. Availability of raw material

To assess the availability of raw material for biogas production, the study seek to find out the factors and

dynamics in play for continued presence of water hyacinth in the lake. Studies show that a combination of anthropogenic and natural factors influence the presence of hyacinth in the lake. Continued pollution of the lake through discharge of waste water, raw sewage, industrial effluents, nutrient leaching/run off from agriculture farms from the various human activities around the lake create conducive environment for water hyacinth to thrive and reproduce. The warm tropic-equatorial climatic conditions present around the lake's ecosystem present favourable climatic condition for water hyacinth growth.

#### L. Energy needs of Ndunga community

Even as the potential of biogas production from water hyacinth is determined, it was important for the study to establish if a positive correlation between potential bio-energy production and community energy needs exist. As such, the study went further to assess the energy needs of Dunga community through profiling current energy sources and related costs, as well as identifying challenges relating to the current energy sources. Community attitude as regards to technological development play a significant role in its acceptance and adoption. Hence the study seek to gather community's views as regards to this technology.

#### M. Current Energy Sources and associated challenges

As a rural area, many households depend on firewood for their cooking energy needs and paraffin for lighting. In some households, young girls are mandated to fetch firewood for the family, thus spending much of their time gathering firewood at the expense of their study time. Whereas in others, they fetch firewood from the bamboo forest located on the shores of the lake. This activity has led to clearing of the bamboo forest, and poses a great hazard to locals who have to fetch firewood from inside the lake.

As such, development in bio fuels from water hyacinth, a product freely available, poses great potential in addressing some of these challenges the community face as it will;

- Bring an alternative solution to energy source. Provide better means of managing the noxious weed and lake in general.
- Provide alternative incentive for community management of the lake.
- Improve livelihoods for communities living around the lake region.
- Boost ecotourism as visitors come to see how the new technology is being used hence opening up the area for development.
- Create more time for children to focus on their studies.
- Help conservation of bamboo woodlots and wetlands around the lakes, hence improved environment.
- Lead to increased harvesting of water hyacinth as well as contribute to clean energy production and reduced carbon emissions from current energy sources (localization of clean energy).

#### N. Water Hyacinth as a Bio-fertilizer

For any technology to be accepted as a viable technology, it not only has to seem beneficial to the community but also

prove to be environmentally friendly, for sustainability purposes. The growing demand for sustainable agricultural practices, has given space to products innovation including application of bio-fertilizers. Bio-fertilizer is known to be a sustainable source of plant nutrients due to its ability to slow nutrient release from the soils whereas improving the soil structure. Digested biomass waste from biogas digesters, otherwise referred to as slurry can be collected for direct application into the farms. From laboratory analysis of data acquired, the concentration of identified minerals is as presented in the table below.

TABLE I  
CONCENTRATION OF MINERALS IN WATER HYACINTH SLURRY

Mineral	Water Hyacinth Samples Concentration (ppm)			
	Samples 1.	Samples 2.	Samples 3.	S.D
Iron	2560	2553	2558	3.6056
Copper	21	21	18	1.7321
Manganese	222.5	221.3	222.2	0.6245
Calcium	1806	1810	1808	1.1547
Phosphorous	795	786.9	791.1	2.3115
Potassium	46060	46054	46066	3
Sodium	3807	3770	3775	2.6457
Magnesium	3110	3111	3121	1.5275

The table I shows results for 3 samples tested, derived average and a standard deviation (SD) analysis of the results to estimate the concentration for each mineral component. Minerals tested include ions of Iron, Copper, Zinc, Magnesium, Manganese, Calcium, Phosphorous and Potassium. The study established that slurry collected as residue from the process of biogas generation from hyacinth biomass can be applied to the farms. However, the study further found out that slurry from digested mixture of water hyacinth biomass and cow dung is high in nutrient content compared to that of purely digested water hyacinth biomass.

The study also established that water hyacinth can be utilized for the generation of biogas for heating as well as bio-methane which can be utilized for generation of electricity. Though production of biogas from water hyacinth falls slightly lower than the production of biogas from cow dung, it's however preferred for this community setting due to the abundant availability of water hyacinth from the lake.

#### **Community Perception with regards to the new technology**

Asked whether they thought production of bio-energy from water hyacinth would benefit the community positively, 90 % of the respondents agreed in enthusiasm noting that such a technology had potential to;

- Bring an alternative solution to current erratic energy sources.
- Provide better means of managing the noxious weed and lake in general

- Provide alternative incentive for community management of the lake
- Improve the livelihoods for the community by raising their living standards
- Boost ecotourism as visitors will come to see how the new technology is been used. Hence opening up the area to development opportunities.
- More time for children to focus on their studies, with reduced amount of time spent fetching firewood.
- Conservation of bamboo woodlots and wetlands around the lakes, hence improved environment.
- Ultimately the technology will lead to increased harvesting of water hyacinth
- Respondents with technical knowledge appreciated the potential contribution to clean energy production and reduced carbon emissions from current energy sources (localization of clean energy production).

#### IV. CONCLUSION AND RECOMMENDATIONS

Investigation into the possibility of utilizing water hyacinth to yield biogas adds value to the seemingly noxious weed and solves the problem of water hyacinth management as well as bridging the gap in energy needs of rural communities living around fresh water ecosystems infested by the hyacinth. Promotion of such technological development leads to significant reduction in dependence of non-renewable energy sources such as wood fuel and paraffin; hence an innovative technology in the reduction of greenhouse gas emissions. Besides the potential for energy production, other valuable bi-products, such as high quality bio-fertilizer are obtained from the water hyacinth digestate which has potential to minimize over reliance on expensive mineral fertilizer. The option of biogas production as a way of energy exploration using water hyacinth not only sustains energy production but also improves environmental sustainability promoting the social and economic wellbeing of Ndunga community, and other communities around the world living within ecosystems infested by water hyacinth.

In conclusion, the study recommended the need for further analysis on emerging plants taking dominance in fresh water ecosystems, such as hippo grass, to complement the usage of water hyacinth as bio-energy producers.

#### REFERENCES

- [1] Aderibigbe, A.O. and A.A. Brown, (1993). Nutritive characteristics of two tropical aquatic weeds for ruminants. *Ife Journal of Agriculture*, 16 & 17: 42-54
- [2] Agency for International Development, (1976). *Making Aquatic Weeds Useful, Some Perspectives for Developing Countries*. Washington D.C.: National Tech. Inf. Ser.; No. PB161-225.
- [3] Ali, M. M. and Soltan, M. E. (1999). Heavy metals in aquatic macrophytes, water and hydro-soils from the river Nile, Egypt. *J. Union Arab Biol.* 9: 99- 115
- [4] Behera D., Balamugesh T. (2005). Indoor air pollution as a risk factor for lung cancer in women. *J. Assoc. Physicians India*; 53:190-192.



- [5] Bhattacharya and P. Kumar (2010). Water hyacinth as a potential bio-fuel crop; National Environmental Sound Production Agriculture Laboratory, University of Georgia, USA.
- [6] Bolenz S, Omran H, and Gierschner K. (1990). Treatment of water hyacinth tissue to obtain useful products. *Bio. wastes* 33:263-274
- [7] Bugaari, H., McNabb, T.J. and Moorhouse, T. (1998). The water hyacinth problem in Lake Victoria, East Africa. Kampala, Uganda, Aquatics Unlimited, Report WP-010298, 9p.
- [8] Center T.D., Julien M.H. and Hill M. P. (1999) Biological control of water hyacinth under conditions of maintenance management: can herbicides and insects be integrated? *Environ. Mngt.* 23:241-256
- [9] De Groot H, Ajuonu O, Attignon S, Djessou R and Neuenschwander P (2003). Economic impact of biological control of water hyacinth in Southern Benin *Ecol Eco.* 45: 105-113
- [10] El-Shinnawi M., Alaa El-Din M., El-Shimi S., and Badawi M. (1989.) Biogas production from crop residues and aquatic weeds. *Res. Conser. Recyc.* 3:33-45
- [11] Freilink, A.B. (1991). Water hyacinth in Lake Victoria: A report on an aerial survey on 12–13 June 1990.
- [12] Ochiel G.R.S. and Stephen W.N. (1999). Biological control of water hyacinth on Lake Victoria, Kenya. Proceedings of the first IOBC Global Working Group Meeting for the Biological and Integrated Control of Water Hyacinth, 16-19 November 1998; Harare Zimbabwe, pp. 115-118 Eds. Hill M.P, Julien M.H. and Center P.
- [13] Gopal, B., Junk, W.J. and Davis, J.A. 2000. Biodiversity in Wetlands: Assessment, Function and Conservation. Volume 1. Backhuys Publishers; Leiden, The Netherlands.
- [14] Gressel J (2008). Transgenics are imperative for bio fuel crops. *Plant Sci.* 174: 246-263
- [15] Government of Kenya, 2007. Kenya Vision 2030. Government Printers, G.O.K., Nairobi.
- [16] Ingole N. W. and Bhole A. G. (2003) Removal of heavy metals from aqueous solution by water hyacinth (*Eichhornia crassipes*), *J Water SRT – Aqua*, 52, 119- 128
- [17] Kumar, P. and Garde, R. J. (1989). Potentials of water hyacinth for sewage treatment. *Research Journal of the Water Pollution Control Federation*, 61, 1702- 1706
- [18] Lindsey K, Hirt H. (1999). Use Water Hyacinth! A Practical Handbook of uses for the Water Hyacinth from Across the World. Anamed: Winnenden, 114.
- [19] Mailu, A.M. (1998). Water Hyacinth Information Bulletin No. 1, June 1998.
- [20] Mooney, H.A. and Hobbs, R.J. 2000. Invasive Species in a Changing World. Island Press; Covelo, CA.
- [21] Ngechu M. 2006 (1<sup>st</sup> ed.): Understanding the research process and methods: An introduct. University of Nairobi press, Nairobi, Kenya
- [22] Almoustapha O., Kenfack S. and Millogo-Rasolodimby J. (2008). Biogas production using water hyacinth to meet collective energy needs in a sahelian country. *Field Action Science Reports*
- [23] Poddar K., Mandal L, Banerjee G. (1991). Studies on water hyacinth (*Eichhornia crassipes*) Chemical composition of the plant and water from different habitats. *Ind. Vet. J.* 68:833-837
- [24] Shoeb F, Singh H.J., (2002). Kinetic studies of biogas evolved from water hyacinth 2nd International Symposium on New Technologies for Environmental Monitoring and Agro – Applications pp 138
- [25] Twongo, T. and Balirwa, J. (1995). The water hyacinth problem and the biological control option in the highland lake region of the upper Nile Basin — Uganda's experience. Unpublished paper presented at The Nile2002 Conference. Comprehensive Water Resources Development of the Nile Basin, held 13–17 February, 1995 Arusha, Tanzania

# Wireless Power Transmission using Solid State Tesla Coils

Benard Mumo Makaa

**Abstract**— Electrical power is crucial to modern systems. From the smallest of sensors and bionic implants to satellites, remote controlled airplanes/cars/robots and oil platforms, it is important to be able to deliver power by means other than wires or transmission lines. The use of wireless power transmission, on a scale larger than used by magnetic induction devices, would allow for systems to operate remotely without the need for relatively large energy storage devices or routine maintenance. It will also be employed in cases where interconnecting wires is inconvenient, hazardous or impossible such as in wet environments, rotating or moving joints as well as powering remote telecommunication equipment.

This paper explores the current wireless power transmission schemes and their practicability. It also delves into theory, design and construction of a method to transmit power through space. To this end, the solid state tesla coil configuration is used as the basis to generate high voltage, high frequency electrical power.

**Keywords**—Wireless, Tesla coil, Electrical power, Induction.

## I. INTRODUCTION

THE idea of transmitting power through the space was conceived over a century ago, with Nikola Tesla's pioneering ideas and experiments perhaps being the most well-known early attempts to do so[1]. His vision was to wirelessly distribute power over large distances using the earth's ionosphere.

Most approaches to wireless power transfer use an electromagnetic (EM) field of some frequency as the means by which the energy is sent. At the high frequency end of the spectrum are optical techniques that use lasers to send power via a collimated beam of light to a remote detector where the received photons are converted to electrical energy.

Efficient transmission over large distances is possible with this approach; however, complicated pointing and tracking mechanisms are needed to maintain proper alignment between moving transmitters and/or receivers. In addition, objects that get between the transmitter and receiver can block the beam, interrupting the power transmission and, depending on the power level, possibly causing harm. At microwave frequencies, a similar approach can be used to efficiently transmit power over large distances using the radiated EM field from appropriate antennas. [2] However, similar caveats

about safety and system complexity apply for these radiative approaches.

It is also possible to transmit power using non-radiative fields. As an example, the operation of a transformer can be considered a form of wireless power transfer since it uses the principle of magnetic induction to transfer energy from a primary coil to a secondary coil without a direct electrical connection. Inductive chargers, such as those found commonly in electric toothbrushes, operate on this same principle. However, for these systems to operate efficiently, the primary coil (source) and secondary coil (device) must be located in close proximity and carefully positioned with respect to one another. From a technical point of view, this means the magnetic coupling between the source and device coils must be large for proper operation.

To overcome the above challenges, that is, to transmit somewhat larger distances or have more freedom in positioning the source and device relative to each other, this paper explores the use of a non-radiative approach that uses resonance to enhance the efficiency of the energy transfer.

## II. LITERATURE REVIEW

### A. Historical Perspective

- In 1864, James C. Maxwell predicted the existence of radio waves by means of mathematical model [3].
- In 1884, John H. Poynting realized that the Poynting Vector would play an important role in quantifying the electromagnetic energy.
- In 1888, bolstered by Maxwell's theory, Heinrich Hertz first succeeded in showing experimental evidence of radio waves by his spark-gap radio transmitter. The prediction and Evidence of the radio wave in the end of 19th century was start of the wireless power transmission.
- Nikola started efforts on wireless transmission in 1891 at his "experimental station" at Colorado [4]. A small incandescent resonant circuit, grounded on one end was successfully lighted.



Figure 1. Wardencllyffe tower also known as tesla's tower (56.9Meters) at long Island, New York.

- Wardencllyffe tower was designed by Tesla for trans-Atlantic wireless telephony and also for demonstrating wireless electrical power transmission.
- William C. Brown contributed much to the modern development of microwave power transmission which dominates research and development of wireless transmission today (figure 2). In the early 1960s brown invented the rectenna which directly converts microwaves to DC current. Its ability was demonstrated by powering a helicopter solely through microwaves in 1964 [5].



Figure 2 Microwave power transmission laboratory experiment in 1975 by W. Brown.

- A physics research group led by Prof. Marin Soljagic at the Massachusetts Institute of Technology (MIT) demonstrated wireless powering of 60W light bulb with 40% efficiency at 2m (7ft) distance using two 60cm – diameter coils in 2007[6]. Resonant induction was used to transmit power wirelessly. The group is also working to improve the technology. The technology is currently referred to as WiTricity and to carry out this technology forward from the MIT laboratories, WiTricity Corp. was launched [6].

## B. Methods of Wireless Transmission of Electrical Power

### a. Near Field Techniques

#### i. Induction.

The principle of mutual induction between two coils can be used to transfer electrical power without any physical contact in between. The simplest example of how mutual induction works is the transformer, where there is no physical contact between the primary and the secondary coils. The transfer of energy takes place due to electromagnetic coupling between the two coils [7].

#### ii. Evanescent Wave Coupling.

This method uses non-radiative electromagnetic energy resonant tunneling. Since the electromagnetic waves tunnel through the air, energy absorption by air is eliminated and electronic devices are not disrupted. Unlike electromagnetic radiation, it is not considered harmful for the human body.

#### iii. Air ionization

The concept here is the ionization of air due to the electromagnetic field produced. This technique exists in nature and its implementation requires high fields of about 2.11 MV/m. Richard E. Vollrath, a California inventor has developed an ingenious sand-storm generator, which sends blasts of dust-laden air through copper tubes, generating electricity which can be stored in sphere and used later [8]. Example of this technique is seen in nature lightning.

#### iv. Electrodynamic Induction

This method is also known as "resonant inductive coupling" and it resolves the main problem associated with non-resonant inductive coupling for wireless energy transfer; specifically, the dependence of efficiency on transmission distance. When resonant coupling is used the transmitter and receiver inductors are tuned to a mutual frequency and the drive current is modified from a sinusoidal to a non-sinusoidal transient waveform. Pulse power transfer occurs over multiple cycles. In this way significant power may be transmitted over a distance of up to a few times the size of the transmitter.

#### v. Electrostatic Induction.

This method is also known as "capacitive coupling". It is an electric field gradient or differential capacitance between two elevated electrodes over a conducting ground plane for wireless energy transmission. It involves high frequency alternating current potential differences transmitted between two plates or nodes.

#### b. Far Field Techniques

Far Field Energy Transfer is mainly dependent on radiative techniques. Waves are either broadcasted in the form of narrow beam transmission of radio, or light waves. This is solely for high power transfer. Tesla already gave the concept to the world on his paper: "Truly Wireless" in late 1880s-based on the Wardencllyffe Tower that was constructed to transfer the energy for large distance [4].

#### i. Radio and Microwave

Power transmission via radio waves can be made more directional, allowing longer distance power beaming, with shorter wavelengths of electromagnetic radiation, typically in the microwave range. A rectenna may be used to convert the microwave energy back into electricity. Rectenna conversion efficiencies exceeding 95% have been realized [9]. Power beaming using microwaves has been proposed for the

transmission of energy from orbiting solar power satellites to Earth and the beaming of power to spacecraft leaving orbit has been considered.

## ii. Electromagnetic Transmission

Electromagnetic waves can also be used to transfer power without wires. By converting electricity into light, such as a laser beam, then firing this beam at a receiving target, such as a solar cell on a small aircraft, power can be beamed to a single target[10].

LASER Technology uses the same principle as microwave wireless transmission but here energy emission is of high frequency and is coherent. The other great advantage of LASER power transmission is the aperture collection efficiency. The antenna can be made small due to the collimation of the beams. LASER transmission does not get dispersed for long distance but it gets attenuated when it propagates through atmosphere.

## C. Need for Wireless Power Transmission

Wireless transmission is employed in cases where instantaneous or continuous energy transfer is needed, but interconnecting wires are inconvenient, hazardous, or impossible (figure 3).



Figure 3 Interconnected wires.

Number of household points receives electricity at the same frequency using single transmitting coil as long as they all are at resonance (figure 4).



Figure 4 Household points receiving electricity from one coil

## D. Technology Benefits and Applications

The interest in highly resonant wireless power transfer comes from many markets and application sectors. There are several motivations for using such technology, and these often fall into one or more of the following categories:

- Make devices more convenient and thus more desirable to purchasers, by eliminating the need for a power cord or battery replacement.
- Make devices more reliable by eliminating the most failure prone component in most electronic systems—the cords and connectors [10].
- Make devices more environmentally sound by eliminating the need for disposable batteries. Companies make about 40 billion disposable batteries each year, and wireless electricity could do away with that [11]. Using grid power is much less expensive and more environmentally sound than manufacturing, transporting, and using batteries based on traditional electro-chemistries.
- Reduce system cost by leveraging the ability to power multiple devices from a single source resonator.
- Charging will likely become possible for mobile devices from different manufacturers via wireless charging pads in public spaces such as cafés, airports, taxis, offices, and restaurants.
- LED (light emitting diode) lights can be directly powered with wireless electricity, eliminating the need for batteries in under-cabinet task lighting, and enabling architectural lighting designers to create products that seemingly float in mid-air, with no power cord[12].
- The unmanned planes or robots (where wires cannot be involved viz: oceans, volcanic mountains etc.) which are run by the wireless power over an area, as they could fly for months at a time, could be used for research.

## E. Solid State Tesla Coil (SSTC)

It is an air-cored resonant transformer capable of generating extremely high voltages. Its construction is relatively straightforward. The key concept of a Tesla Coil is its resonant property, where a Resistor-Inductor-Capacitor (RLC) resonant circuit is energized at its resonant frequency, developing very high voltages [13].

A Tesla Coil consists of two concentric coils which are not electrically connected to each other. The Primary Coil usually consists of a few turns of heavy wire, and has a shape ranging from a solenoid to a flat spiral. This coil is usually connected to some capacitor, forming the Primary LC circuit. The secondary circuit consists of a long coil of wire, usually having several hundreds to thousands of turns wound on a pipe, and placed concentrically in the middle of the coil [14]. The control circuit consists of solid state devices.

## III. SYSTEM DESIGN.

A solid state tesla coil usually has these key components:

- Power source.
- Switching circuit. The circuits that make the tesla coil work at the correct frequency and duty cycle.
- Primary coil. The primary coil (figure 5) is powered by the control circuitry and generates the magnetic field that the secondary use to create the high voltage. It is the few turns of thick wire at the base of the secondary coil.

- Secondary coil .The secondary coil (figure 5) is a long cylinder. It is PVC pipe covered by an enameled wire. One side is connected to ground; high voltage comes through the other side.
- The Top load: The top load is the metallic object at the top of the secondary coil. It provides a capacitance to the Tesla coil.

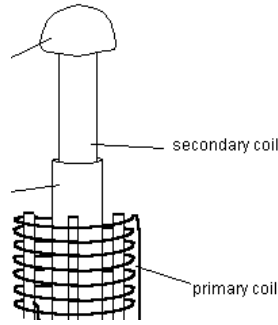

Figure 5 Secondary and primary coils.

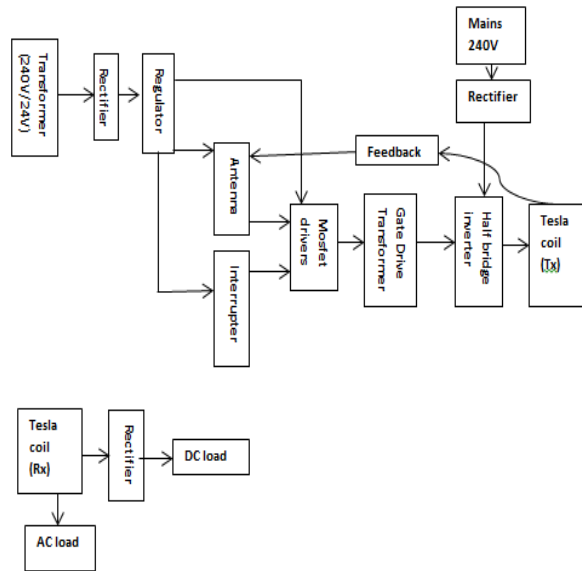

Figure 6 Functional block diagram

It shows how the system modules relate to one another.

#### A. System Modules

- Two power supplies are provided-One that powers the tesla coil switching circuit and the other the primary coil (Figure 6).
- The Interrupter (Figure 7) turns turn the Tesla coil on and off at a certain frequency. This doubles as a power control if the duty cycle of the circuit is varied.

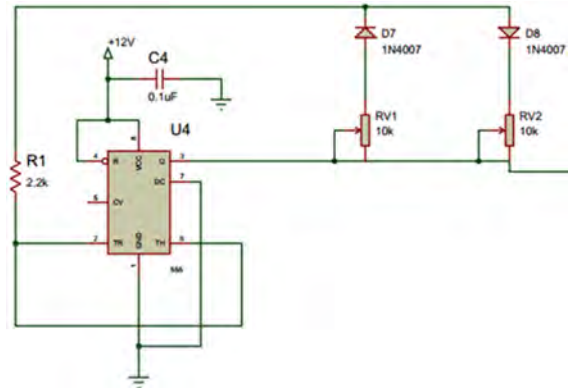

Figure 7 The Interrupter

- Antenna section. It is the feedback mechanism (figure 8). This part of the circuit is designed to capture feedback from the secondary coil to keep the circuit resonating. The antenna could be any straight piece of wire connected to the circuit. The other end is left unconnected.

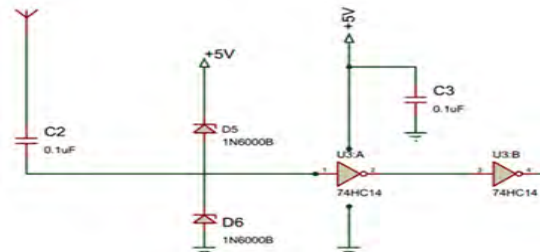

Figure 8 Antenna section

A solid state Tesla coil works by switching the primary coil at a resonant frequency. This frequency varies due to the height of the coil, the top load, and the environment [14]. Thus, a fixed frequency oscillator is not ideal.

The used driver changes its frequency based on what the antenna receives from the Tesla coil. Antenna feedback is designed to capture feedback from the secondary to keep the circuit resonating. Because we use feedback to provide the signal to the half bridge, the coil is always in tune. Using schottky diodes (diodes with a low forward voltage drop, and hence, fast) to clamp the signal to ground and +Vcc, to ensure the drive is not destroyed; a square signal to the driver input is obtained.

- Gate drive. This part of the circuit combines and amplifies the interrupter and feedback signals to drive the gate drive transformer (figure 9). The circuit works by generating a square wave from the respective outputs of the inverting and non-inverting MOSFET drivers and they operate in phase.

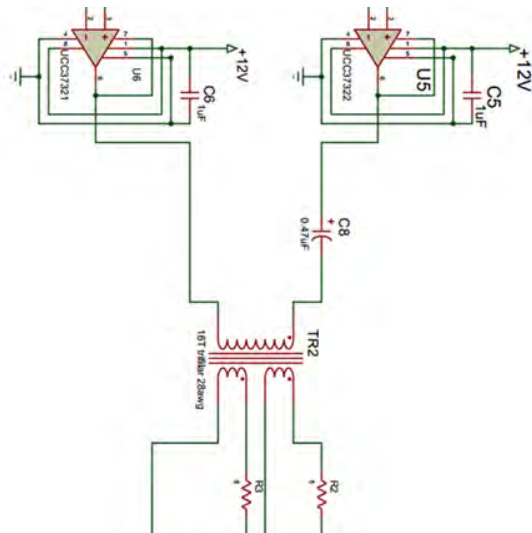

Figure 9 Gate drive

- Gate drive transformer. Isolates the switching circuit (figure 10).

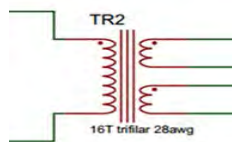

Figure 10 Gate drive

- Half bridge Inverter. These are two MOSFET that alternate switching on and off to produce alternating current (figure 11). This is done at a high voltage, mainly so that power can be pumped through the primary coil. This causes a magnetic field to be formed that excites the secondary coil (resonator).

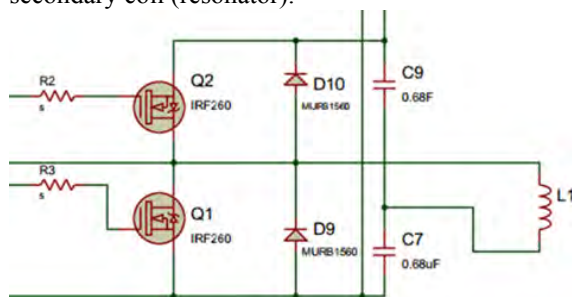

Figure 11 Half bridge Inverter

- Two tesla coils; Transmitter and receiver.

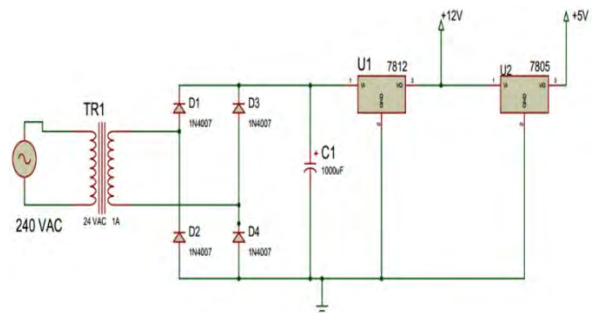

Figure 12 Power supply to control circuit

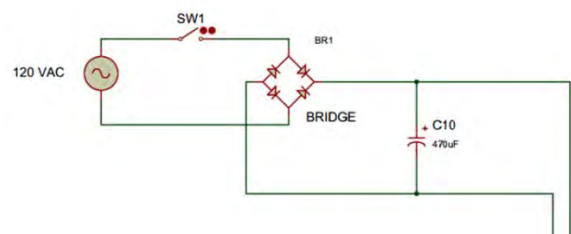

Figure 13 Power supply to the half bridge

### B. Tesla Coil Design.

The inductance of a coil can be estimated using equation 1:

$$L_{solenoid} = \frac{\mu_0 N^2 \pi a^2}{b} [\text{Henry}] \quad (1)$$

Where  $\mu_0$  is the permeability of free space and a and b are expressed in meters. N is the number of turns.

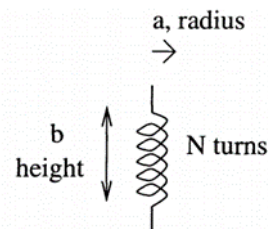

Figure 14 Cartoon of a solenoid Inductor with marked dimensions.

where 'a' is the radius of the coil and 'b' the height of the coil.

#### a. Wheeler's Formula

The Wheeler's formula was used to estimate the inductance of the Tesla coil.

$$L_{solenoid} = \frac{a^2 N^2}{9a + 10b} [\mu H] \quad (2)$$

Note that a and b are expressed in inches.

#### b. Estimating Capacitance

Medhurst Capacitance

$$C_o \approx 2Ha [pF] \quad (3)$$

Where a is radius of the solenoid in centimeters and H is a factor based on the Medhurst table [15].

The Spherical top load capacitance was estimated using the formula:

$$C = 4\pi\epsilon_0 R \quad (4)$$

where R is radius in meters, and  $\epsilon_0$  permittivity of free space.

#### IV. RESULTS & DISCUSSION

The transmitter Tesla coil (figure 16) consisted of 10 primary turns while the secondary consisted of 530 turns made of 14AWG (1.63mm) enameled copper wire and 23AWG (0.51mm) enameled copper wire respectively.

The receiver Tesla coil (figure 17) consisted of 250 primary turns while the secondary consisted of 50 turns all made of 23AWG (0.51mm) enameled copper wire respectively.

The receiver circuit (figure 15) consisted of nine concentric led lamps and power control circuit.

The control circuit (figure 14) consisted of sub-circuits that make the tesla coil work at the correct frequency and duty cycle.

The transmitter primary was fed with 20v ac power at 50Hz; the output was 1060v ac power at 73 KHz. The theoretical resonant frequency was calculated to be 67.4 KHz. The deviation in the actual resonance frequency from the theoretical resonance frequency is due to the imperfections in designing the Tesla coil. Parasitic capacitance and inductance also contributed to this difference.

Nine Led lamps were light at a distance of 1 meter. It had a typical efficiency was 40% for a distance of 1m.Losses in the control circuit and the half bridge were major constraints.

Power transmission was maximum when a common ground was used between the transmitter and the receiver.

Figure 15 Receiving Circuit



Figure 16 Transmitter Tesla coil



Figure 17 Receiver Tesla coil

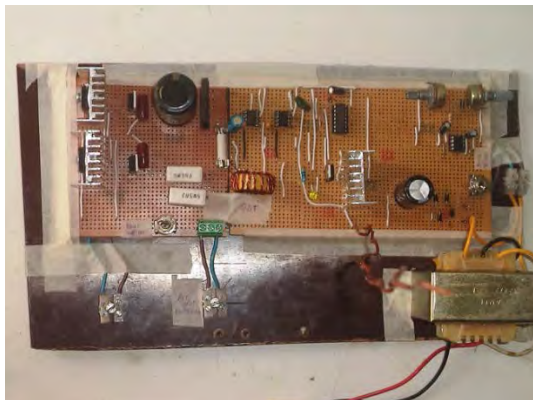

Figure 13 Control Circuit



#### V. CONCLUSION.

The main objective of this paper was to demonstrate wireless power transmission using solid state tesla coils. Tesla coils are remarkable devices able to generate high voltage, high frequency waveforms with little control circuitry. Most of the builders of Tesla coils are interested in producing electric arcs and visible effects suitable for displays and general amusement, not in producing power supplies and power effects units which may have significant practical importance. The paper has demonstrated that tesla coils can be designed for wireless power transmission.

Further improvements to be made on the design include:

- Design of a full wave inverter to power the Tesla coils. This will minimize the losses since full wave inverters do not exhibit the losses prevalent in half wave rectifiers.
- A better feedback mechanism can be adopted instead of using a wire. A small current-transformer on the secondary coil can be used, instead, to obtain feedback. This is constructed by wrapping around 50 turns of wire on a small ferrite core with the secondary wire going through this ring on the ground side. Care must be taking to ensure the right phasing.

## REFERENCES

- [1] Nicola Tesla, "The transmission of electrical energy without wires", *Electrical World and Engineer*, March 1905. Available: <http://www.tfcbooks.com/tesla/1904-03-05.htm>, (acc. May. 2014).
- [2] William C. Brown, "The history of power transmission by radio waves", *Microwave Theory and Techniques*, IEEE Transactions, 32(9):1230-1242, September 1984.
- [3] J. C. Maxwell, *A Treaty of Electricity and Magnetism*, 1st ed. New York, U.S.A.: Cambridge University Press, 1873.
- [4] Nikola Tesla, "The Transmission of Electrical Energy without Wires as a means for Further Peace," *Electrical World and Engineering*, p. 21, January, 7 1905.
- [5] William C. Brown and E. Eugene Eves, "Beamed Microwave Power Transmission and its Application to Space," *IEEE Transactions on Microwave Theory and Techniques*, vol. 40, no. 6, pp. 1239-1250, June 1992.
- [6] Franklin Hadley. (2007, June) MIT news: Goodbye wires. Available: <http://newsoffice.mit.edu/2007/wireless-0607>. (acc. Feb. 2015).
- [7] "Wireless energy transfer" Wikimedia Foundation, Inc. [http://en.wikipedia.org/wiki/Wireless\\_energy\\_transfer](http://en.wikipedia.org/wiki/Wireless_energy_transfer).
- [8] Edwin Teale, "New Discoveries Shows Electricity Governs our Lives," *Popular Science*, vol. 124, no. 2, p. 11, February 1934.
- [9] William C. Brown and E. Eugene Eves, "Beamed Microwave Power Transmission and its Application to Space," *IEEE Transactions on Microwave Theory and Techniques*, vol.40, no. 6, pp. 1239-1250, June 1992.
- [10] Mohammed, S., Ramasamy, K., & Shanmuganatham, T. (2010). Wireless Power Transmission - A Next Generation Power Transmission System. *International Journal Of Computer Applications*, 1(13), 102-105. doi: 10.5120/274-434.
- [11] A cordless future for electricity? - CNN.com. Available: <http://edition.cnn.com/2009/TECH/09/02/wireless.electricity/index.html?iref=nextin>. (acc.Feb 2015).
- [12] Kesler, M. (2013). *Witricity* (1st ed.). Retrieved from <http://www.witricity.com/assets/highly-resonant-power-transfer-kesler-witricity-2013.pdf>
- [13] Craven, R. (2014). A study of secondary winding designs for the two-coil Tesla transformer (PhD.). Loughborough University.
- [14] Johnson, G. (2001). *SOLID STATE TESLA COIL* (1st ed.). Manhattan. Retrieved from [http://www.g3ynh.info/zdocs/refs/Tesla/Johnson2001\\_ssTeslacoil.pdf](http://www.g3ynh.info/zdocs/refs/Tesla/Johnson2001_ssTeslacoil.pdf).
- [15] R.G.Medhurst. High frequency resistance and self-capacitance of single-layer solenoids. *Wireless Engineer*, 24(281):35-43, Feb.1947



# Simultaneous Consideration of Bus Voltage and Frequency in Load Shedding in a High Voltage AC Network

Mwaniki C, Muriithi C. M, Abungu N. O

**Abstract**—Load shedding schemes proposed in literature so far use voltage and frequency parameters separately. The individual consideration of these indices may not be reliable or effective, and may even lead to the over load shedding problems. Analysis of under-frequency load shedding is often done using the system frequency response models. The impact of voltage variation on the frequency deviation is not considered in these models. Furthermore, the under-voltage load shedding methods that are proposed for adjusting the under-voltage relays, do not consider the frequency behavior. This paper focuses on establishing the variation and the extent of dependence of these parameters on each other whenever a power system undergoes a disturbance due to loss of a transmission line and a generator.

**Keywords**- Voltage stability, Frequency stability, under frequency load shedding, under voltage load shedding.

## I. INTRODUCTION

Most Load Shedding schemes proposed use voltage and frequency parameters, separately and also, the under-frequency and under-voltage relays work in the power system without any coordination. The individual use of these indices may not be reliable/effective, and may even lead to the over load shedding problems. These two parameters (voltage and frequency) are not independent and the coordination between UFLS and UVLS schemes is therefore crucial. The dependency between voltage and frequency will affect LS performance. The following paragraphs present several methods that consider these parameters separately.

One of the methods that consider only the voltage is suggested [1]. In this method, load shedding is carried out in two conditions. One, where the load shedding occurs due to a post disturbance low voltage condition and secondly, where the load shedding results due to the inability of the system to achieve a stable operating condition during post disturbance. This method uses the load flow in order to decide the buses from which to shed load. The initial set of control actions are first carried out. These actions are capacitor switching, tap changing transformer and secondary voltage control.

Another method that considered voltage only was developed with risk indices in order to decide which buses

should be targeted for load shedding to maintain voltage stability [2]. The buses with a high risk of voltage instability are considered first. This is estimated from the probability of a voltage collapse occurrence. The risk indices are the products of these probabilities and impact of voltage collapse.

In another method, a suggestion of offering economic incentives to customers for discontinuing the use of power during load control periods is presented [3]. This way the brunt of a sudden load shed is not borne by the customer alone. Also, systematic load control will lead to the stability of the system even when it is not faced with a disturbance.

A new method for planning the VAR allocation using the FACTS devices is suggested [4]. Here, the total economic cost for a voltage collapse along with its corrective control and load shedding are taken into account to come up with the optimum VAR planning scheme. Thus, the objective function is to minimize the cost while keeping in mind the voltage stability of the system.

A method that uses distributed controllers which are delegated with a transmission voltage and a group of loads to be controlled is presented [5]. Each controller acts in a closed loop, shedding loads that vary in magnitude based on the reference voltage. Each controller acts on a set of electrically close loads and monitors the voltage of the closest transmission bus in that area. The controller is rule based where the rules are simple if-then statements.

A method that considers the frequency separately is presented [6]. In this method, the System Frequency Response SFR and the Under Frequency Load Shedding UFLS are used together to get a closed form expression of the system frequency such that the UFLS effect can be included in it. The system and UFLS performance indicators can then be calculated. Thus these indicators can be used efficiently in any further optimization techniques of SFR – UFLS model. One such method has been discussed using the regression tree [7]. The regression tree is utilized to interpolate between recorded data to give an estimate of the frequency decline after a generator outage. It is a non-parametric method which can select the system parameters and their relations which are most relevant to the load imbalance (due to generator outage) and the frequency decline. The case considered here is only a generator outage but this method can be applied to other forms of disturbances as well.

A Kalman filtering-based technique [8] estimates frequency and its rate of change which is beneficial for load shedding. The noisy voltage measurements are used to estimate the

Mwaniki C, Department of Electrical & Electronic Engineering, JKUAT  
Tel: +254-733-318-441; e-mail: mwanikicharles2005@yahoo.com.

Muriithi C. M, Department of Electrical & Electronic Engineering, JKUAT  
Email: cmmuriithi@eng.jkuat.ac.ke;

Abungu N. O, Department of Electrical & Electronic Engineering, UON,  
Email: abunguodero@uonbi.ac.ke

frequency and its rate of change. A three-state extended Kalman filter in series with a linear Kalman filter is used in a two stage load shedding algorithm. The output of the three stage Kalman filter acts as the input to the linear Kalman filter. It is the second filter which identifies linear components of the frequency and its rate of change. The amount of load to be shed is calculated using the linear component of the estimated frequency deviation.

The methods discussed above clearly consider both frequency and voltage parameters in the analysis of load shedding. However these parameters are considered separately. The dependency between these parameters in the proposed methods of load shedding is missing. These two parameters are not independent and the coordination between UFLS and UVLS schemes is therefore crucial. It is therefore important to establishing the extent of dependence of these parameters on each other whenever a power system undergoes a disturbance due to loss of a transmission line.

## II. METHODOLOGY

The IEEE 14-bus system was selected for the study. The data for the system is readily available and this would ensure the validity of the results obtained. The power flow analysis was first carried out using the fast decoupled power flow technique to establish the loading levels of various transmission lines in the system. The main idea in this step is establish the heavily loaded line whose loss is likely to affect the performance of the entire system. This analysis was carried out using Power system Analysis Toolbox (PSAT). PSAT is a Matlab toolbox for static and dynamic analysis and control of electric power systems.

Equation 1 represents a linealized model of power system at an operating point

$$\begin{bmatrix} \Delta \\ \Delta \end{bmatrix} = \begin{bmatrix} \Delta \\ \Delta \end{bmatrix} \quad (1)$$

By letting  $\Delta = 0$  in equation 1

$$\Delta = 0 \quad \Delta \quad \Delta, \Delta \quad \Delta \quad (2)$$

and

$$\Delta \quad \Delta \quad \Delta \quad (3)$$

Substituting equation 2 into equation 3

$$\Delta \quad \Delta \quad (4)$$

where

is the reduced Jacobian matrix of the system

Equation (4) can be written as

$$\Delta \quad \Delta \quad (5)$$

Eigenvalue analysis of results in the following:

$$\Delta \Gamma \quad (6)$$

Where

$$\begin{aligned} &= \text{right eigenvector matrix of} \\ \Gamma &= \text{left eigenvector matrix of} \\ \Lambda &= \text{diagonal eigenvalue matrix of} \end{aligned}$$

Equation (5) can be written as

$$\Lambda \quad \Gamma \quad (7)$$

Equation (5) can be written as

$$\Delta \quad \Lambda \quad \Delta \quad (8)$$

or

$$\Delta \quad \frac{\Gamma}{\Delta} \Delta \quad (9)$$

Where  $\lambda_i$  is the  $i^{\text{th}}$  eigenvalue,  $\Gamma_i$  is the  $i^{\text{th}}$  column right eigenvector and  $\Gamma_i$  is  $i^{\text{th}}$  row left eigenvector of matrix  $\Lambda$ . The  $i^{\text{th}}$  modal voltage variation is:

$$\Delta \quad \frac{1}{\Delta} \Delta \quad (10)$$

From equation (10) large values of  $\Delta$  suggests small changes the modal voltage for reactive poeower changes. As the system is stressed, the value of  $\Delta$  becomes smaller and the modal voltage becomes weaker. Once the minimum eigenvalues and the corresponding left and right eigenvectors have been calculated the participation factor can be used to identify the weakest node or bus in the system. The weakest mode and the buses parcipating in this mode was determined using PSAT.

A Matlab m-file was developed to compute the eigevalues,the parcipating factor of  $i^{\text{th}}$  mode, and time domain simulation of the system.

```
% Initialize PSAT
initpsat;
%Set data file testcase3.mdl
runpsat('testcase4_mdl','data');
%Solve base case power flow
runpsat('pf');
% Write current power flow solution
runpsat('pfrep');
%Carry out time domain simulation
runpsat('td');
%Invoke GUI for plotting results
fm_plotfig()
```

During the simulation a circuit breaker associated with the heavily loaded line activated at time 10. The frequency and voltage at the buses was captured and plotted.

### III. RESULTS AND ANALYSIS

Table I and table II shows the results obtained from power flow. Table II shows that line 11 connected between Bus 1 and Bus 2 was the most heavily loaded line and its loss would be significant to the performance and equilibrium of the system. It's for this reason that this line was chosen for investigation.

Table III represents the eigenvalues of reduced Jacobian matrix of the system. The eigenvalues gives the most critical mode to system voltage instability. The system has all eigenvalues real parts being positive indicating that the system is statically stable. The most critical mode was mode 9 whose eigenvalue had the smallest real part value of 1.0722

Table IV and figure 1 shows that the most associated bus was Bus 14 followed by Bus 10, Bus 12 and Bus 9. Bus 1 and Bus 2 were least associated with instability.

Figures 2, 3, 6, 7 and 8 represent the response of frequency and voltage when circuit breakers associated with line 11 are opened at time  $t = 10s$ . Immediately the line was opened, the voltage in all the buses dropped significantly as depicted in figure 3. A similar response of a drop was found with Bus frequencies. However there was rise in frequency in the most critical buses with Bus 14 frequency rising almost immediately followed by Bus 10 and the Bus 13. Both frequency and voltage of the least critical Buses 1 and 2 dropped when line 11 opened.

Figures 4 and 5 represent the response of frequency and voltage when circuit breakers associated with the generator is opened at time  $t = 10s$ . Immediately the generator was lost, the bus voltages at the critical buses dropped drastically before rising again exponentially to settle at final value lower than that before disturbance. During the same time the frequency at those buses rose gradually and equally to settle at a value higher than the value before disturbance.

Table I Power flow results

From Bus	To Bus	Line	P Flow (p.u)	Q Flow (p.u)	P Loss (p.u)	Q Loss (p.u)
Bus 2	Bus 5	1	0.57838	0.07	0.01785	0.01885
Bus 6	Bus 12	2	0.11407	0.04591	0.00162	0.00338
Bus 12	Bus 13	3	0.02704	0.02014	0.00023	0.00021
Bus 6	Bus 13	4	0.25989	0.14446	0.00511	0.01006
Bus 6	Bus 11	5	0.1186	0.12844	0.00254	0.00531
Bus 11	Bus 10	6	0.06706	0.09793	0.00108	0.00252
Bus 9	Bus 10	7	0.06013	-0.01389	0.00012	0.00031
Bus 9	Bus 14	8	0.12001	0.00518	0.00179	0.0038
Bus 14	Bus 13	9	-0.09038	-0.06862	0.00221	0.00451
Bus 7	Bus 9	10	0.37857	0.22523	0	0.01989
Bus 1	Bus 2	11	<b>2.4172</b>	<b>-0.38062</b>	<b>0.10291</b>	<b>0.2557</b>
Bus 3	Bus 2	12	-1.0022	0.13952	0.04747	0.15375
Bus 3	Bus 4	13	-0.31661	0.19184	0.00947	-0.01071
Bus 1	Bus 5	14	1.1031	0.09865	0.05928	0.19231
Bus 5	Bus 4	15	0.84856	-0.13731	0.00978	0.01805
Bus 2	Bus 4	16	0.7825	0.05026	0.03285	0.06063
Bus 5	Bus 6	17	0.64936	0.0724	0	0.09291
Bus 4	Bus 9	18	0.21456	0.04349	0	0.02514
Bus 4	Bus 7	19	0.33402	-0.06267	0	0.02958
Bus 8	Bus 7	20	0	0.33402	0	0.01654

Table II Line flow results

BUS	Voltage (p.u)	Phase (rad)	P Gen (p.u)	Q Gen (p.u)	P Load (p.u)	Q Load (p.u)
Bus 1	1.06	0	3.5203	-0.28197	0	0
Bus 2	1.045	-0.13568	0.4	0.9486	0.3038	0.1778
Bus 3	1.01	-0.33212	0	0.59736	1.3188	0.266
Bus 4	0.99782	-0.26441	0	0	0.6692	0.056
Bus 5	1.0029	-0.22695	0	0	0.1064	0.0224
Bus 6	1.07	-0.36956	0	0.44433	0.1568	0.105
Bus 7	1.036	-0.33938	0	0	0	0
Bus 8	1.09	-0.33938	0	0.33402	0	0
Bus 9	1.0129	-0.37908	0	0	0.413	0.2324
Bus 10	1.0122	-0.38446	0	0	0.126	0.0812
Bus 11	1.0357	-0.37984	0	0	0.049	0.0252
Bus 12	1.0462	-0.39059	0	0	0.0854	0.0224
Bus 13	1.0366	-0.39147	0	0	0.189	0.0812
Bus 14	0.99695	-0.41056	0	0	0.2086	0.07

Table III Eigenvalues of the dynamic power Jacobian Matrix

Eigen value	Most Associated Bus	Real Part	Imaginary Part
1	Bus 1	1601.9991	0
2	Bus 4	64.6693	0
3	Bus 2	49.3833	0
4	Bus 9	38.7603	0
5	Bus 6	31.9118	0
6	Bus 3	24.3448	0
7	Bus 7	21.8383	0
8	Bus 13	17.3558	0
9	Bus 14	<b>1.0722</b>	0
10	Bus 11	12.6507	0
11	Bus 4	10.9946	0
12	Bus 12	3.9803	0
13	Bus 8	7.3388	0
14	Bus 14	6.2626	0

Table IV Participation factors of buses in the most critical mode 9

Bus	Participation Factor	Bus	Participation Factor
Bus 1	0	Bus 8	0.0239
Bus 2	0.00147	Bus 9	0.11274
Bus 3	0.00202	Bus 10	0.1358
Bus 4	0.01644	Bus 11	0.12725
Bus 5	0.01467	Bus 12	0.12901
Bus 6	0.07214	Bus 13	0.1248
Bus 7	0.06038	Bus 14	0.17939

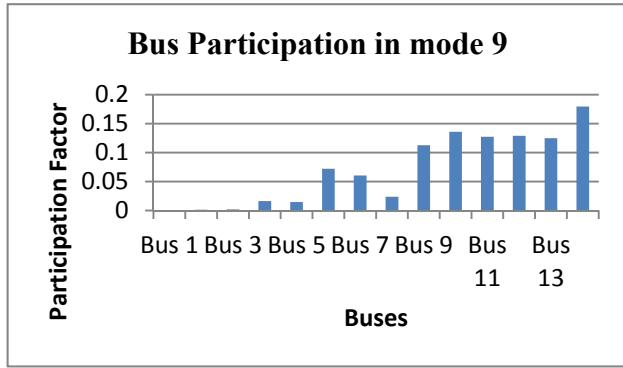

Fig 1: Bus participation in mode 9

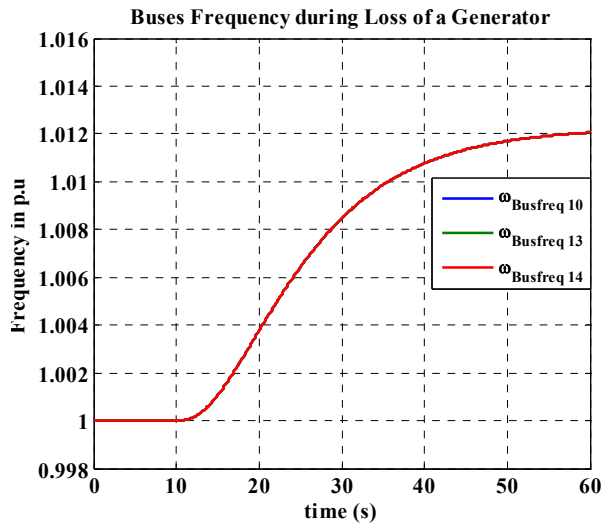

Fig 4: Bus frequency variation upon loss of a generator

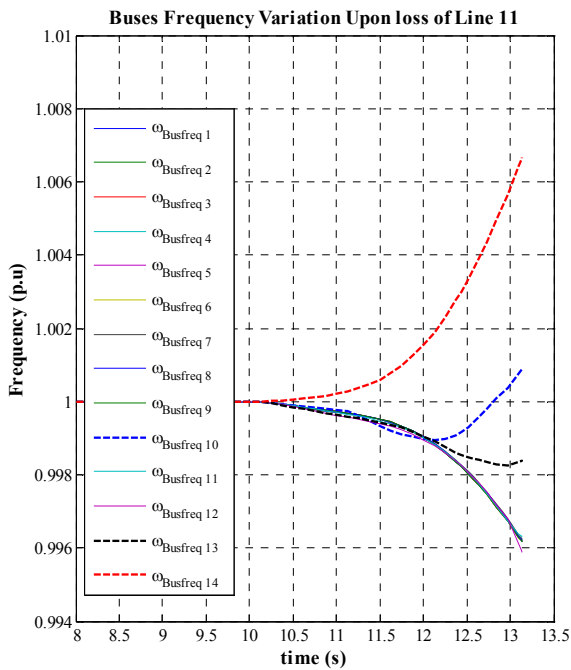

Fig 2: Bus Frequency Variation Upon Loss of Line 11

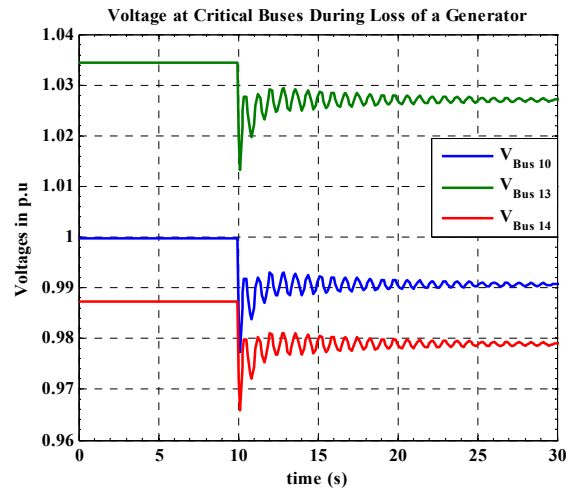

Fig 5: Bus voltage variation upon loss of a generator

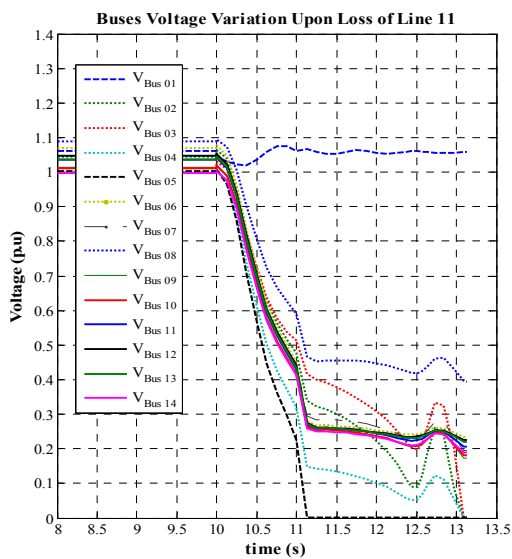

Fig 3: Bus voltage variation upon loss of line 11

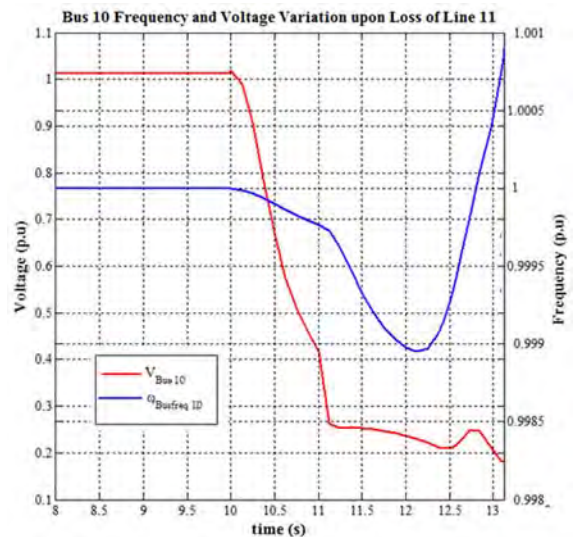

Fig 6: Bus 10 frequency and voltage variation upon loss of line 11

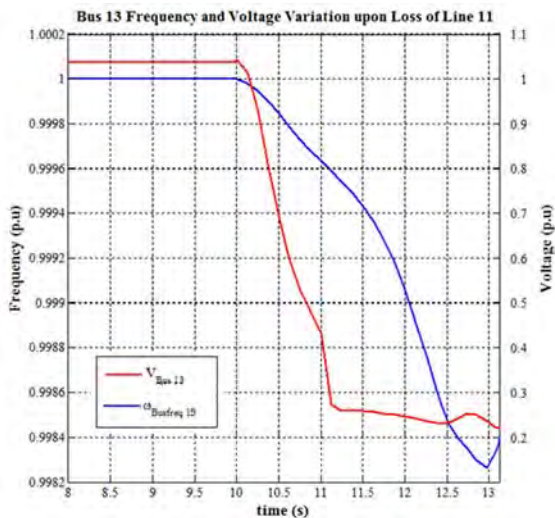

Fig. 7: Bus 13 frequency and voltage variation upon loss of line 11

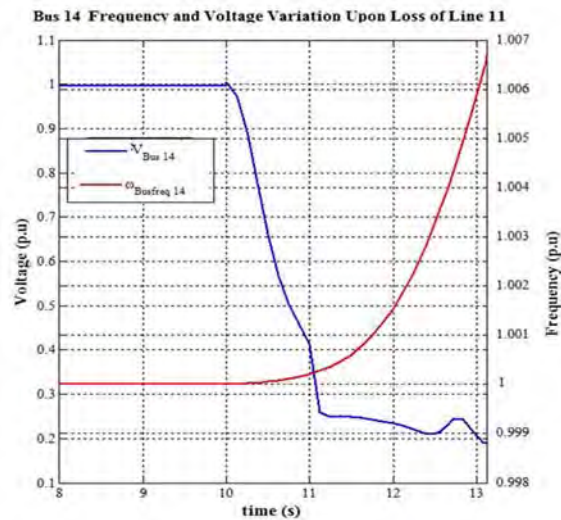

Fig. 8: Bus 14 frequency and voltage variation upon loss of line 11

#### IV. CONCLUSION

The loss of a high voltage transmission line or a generator affects both bus voltage and bus frequency. Therefore both frequency and voltage parameters may be considered jointly in order to develop a load shedding scheme that utilizes both parameters jointly for a more effective load shedding. There is therefore need for more work to be carried out in developing algorithms that can apply both frequency and voltage parameters for better load shedding schemes.

#### REFERENCES

- [1] G. O. Young, "Synthetic structure of industrial plastics (Book style with paper title and editor)," in *Plastics*, 2nd ed. vol. 3, J. Peters, Ed. New York: McGraw-Hill, 1964, pp. 15–64.
- [2] Lopes B. Isaias Lima, A.C. Zamboni de Souza, An Approach for Under Voltage Load Shedding, Power Tech Conference Proceedings, 2003 IEEE Bologna (Volume:1 ) June 2003 .
- [3] Dai Jianfeng, Zhou Shuangxi, Lu Zongxiang. A New Risk Indices Based Under Voltage Load Shedding Scheme., Transmission and Distribution Conference and Exhibition: Asia and Pacific, 2005 pg 1-5

- [4] Shamir S. Ladhani, William Rosehart. Criteria for Load Control when Considering Static Stability Limits. Power Engineering Society General meeting, 2005, IEEE, vol 2 pg 1558 – 1562
- [5] Naoto Yorino, E. E. El-Araby, Hiroshi Sasaki, Shigemi Harada. A New Formulation for FACTS Allocation for Security Enhancement Against Voltage Collapse. Power Systems, IEEE transactions, 2003, vol 18, issue 1, pg 3-10
- [6] Charles J. Mozina (Beckwith Electric Co., Inc.). Under voltage Load Shedding., Power Systems Conference: Advanced Metering, Protection, Control, Communication, and Distributed Resources, 2007. Pg 39-54
- [7] Denis Lee Hau Aik. A General-Order System Frequency Response Model Incorporating Load Shedding: Analytic Modeling and Applications, IEEE Transactions on Power Systems, 2006, Vol. 21, No.2.
- [8] Rung-Fang Chang, Chan-Nan Lu, Tsun-Yu Hsiao. Prediction of Frequency Response After Generator Outage Using Regression Tree, IEEE Transactions On Power Systems, 2005, Vol. 20, No. 4.
- [9] Adly. A. Girgis, William Peterson . Adaptive estimation of frequency deviation and its rate of change for load shedding. Power Delivery, IEEE Transactions on Power systems Volume: 5 , Issue: 2

# A Novel Method for Lattice Tower Vandalism Eradication

Charles Ndung'u and J. Nderu

**Abstract**— This study aims in eradicating vandalism of lattice tower steel bracings which in the recent time has increased rapidly. Due to financial constraints, some members of the society has engaged in vandalizing of steel bracings which are used as scrap metals hence adversely affecting transmission lines reliability. In recent time, Kenya Power has incurred high losses due to vandalism of steel bracings in most of its transmission lines particularly those traversing through rural area. For instance 2014, the power utility – KPLC spent millions of money after four towers collapsed due to vandalism of steel bracings. In addition, Company spends money on daily ground patrol along the transmission lines to ensure the towers are in good condition. Because of this perpetual problem, there is need for researching a better method of reducing/ eradicating the steel tower vandalism. In this regards, a novel surveillance system has been designed and implemented to monitor and alert the Company management of any vandalism attempt on lattice tower. Lattice tower is a frame construction of angled- profiled galvanized steel. It is usually assembled at the point where it is to be erected. Lattice tower is commonly used for transmission of high voltage transmission line; AC or DC, and communication mast. It is the single unit most expensive in transmission line construction. Lattice tower can be either self-supporting or guyed tower. Guyed towers are most vulnerable to collapse when substantial bracings are vandalized. The novel method constitutes of a solar panel, rechargeable battery, battery charger, alarm system, warning system, communication system, vibration and motion detectors. Vibration and motion sensors detect presence of ‘vandal’ and send a signal to the control system which depending on the rate of incoming signal, the system either send a message to the designated numbers, or switch on the buzz and warning system or either both. Solar panel and rechargeable battery are to supply power to the system. This implies that the vandals will be scared away and the power utility will be informed of vandalism attempt on a particular tower along a specific transmission line

**Keywords**— Tower, steel bracings, vandals, Kenya Power

## I. INTRODUCTION

LATTICE towers are steel framework construction used for different purposes such as supporting overhead conductors, communication cables (OPGW) and lightning shielding conductor wire. Towers are also used in radio transmission, satellite receptions, flood light stands, oil drilling mast, meteorological measurements etc. [1]. They are single most expensive component in a transmission line. Transmission towers are of different shape and sizes. There

are four types of towers namely suspension (line tower), terminal, tension and transposition tower. Tower structure can be tubular, lattice, wooden, concrete, fiberglass or aluminum. Lattice towers are preferred because of ease of erecting them on site and relatively low cost compared to tubular (monopole) towers. They consist of steel framework of angle-profiled galvanized steel braces which are arranged in many forms, and carry solely tension, or alternatively tension and compression [2]. Bracings hold the structure stable by transferring the loads sideways down to the ground. In addition they are also used to resist lateral loads, thereby preventing sway of the structure against side sway or drift. If some bracings are removed, the compression members would buckle leading to failure of the lattice tower.

Lattice towers, however, are faced with a major challenge of vandalism of steel bracings. This involves removal of angle-profiled galvanized steel braces by vandals where they sell them as scrap metals mostly to informal sector. As result, this compromises the safety factor of the tower hence making it buckle leading to failure of the affected tower. The consequence is tremendous as it usually causes system disturbances which may result to national wide power blackout. As result, it causes loss of sale of electricity to power utility, cost for transport of labors and materials to the site of where the tower has collapsed, and hiring tower erecting equipment.

Some of the mitigation measures the power utility company has undertaken to combat steel bracings menaces are [4].

- i. Routine inspection (Ground and aerial patrol).
- ii. Painting bracings color red
- iii. Use of anti- theft bolt (shearing bolt).
- iv. Involving police and local chiefs to guard towers.
- v. Punching the bracings
- vi. Use of anti-climbing devices

The number of bracings vandalized on Kenya Power lattice towers as depicted in table 1 are approximately 1,800 pieces. From the data obtained, it is evident that vandalism is rampant on power utility transmission line structures. The figure 1 shows a double circuit self-supporting lattice steel bracings tower [2].

## II. TOWER SURVEILLANCE SYSTEM

The aforementioned mitigation methods have not been effective in eradicating vandalism on lattice steel bracing

C. Ndung'u, Department of Transmission, Kenya Power (e-mail: cndungu03@yahoo.com).

J. Nderu, Department of Electrical Engineering, JKUAT (e-mail: jnderu@jkuat.ac.ke).

towers. There is need for an advanced method which offers a better solution of ‘guarding’ the lattice towers. The surveillance method proposed consists of a solar panel, rechargeable battery, battery charger, alarm system, lighting system, communication system and motion and vibration detector [3]. Motion and vibration sensors detect the vandals as they climb up the tower and trigger on the alarm system (buzz), light up LED siren light, and send a short message to control center or any contracted security firm. The short message contains details such as tower number, location and transmission line. The figure 2 below illustrated how the system be realized.

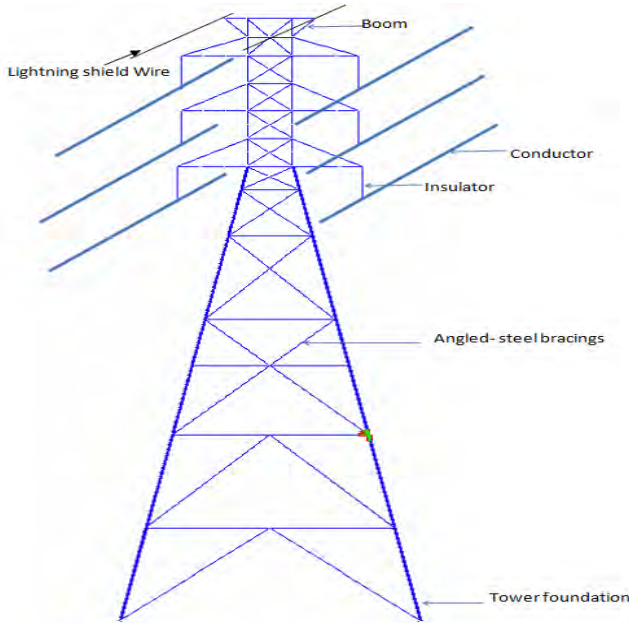

Fig. 1. Double circuit lattice self-supporting steel tower

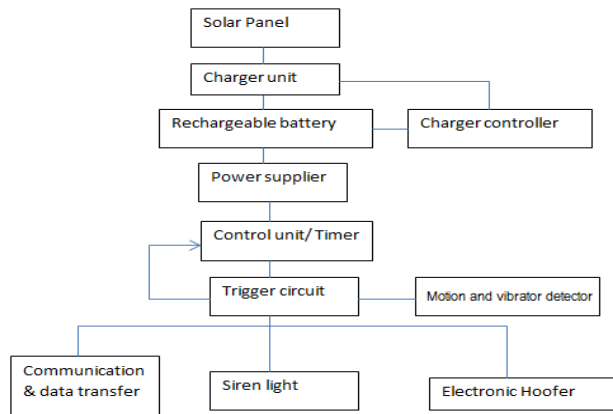

Fig. 2: Novel method for tower surveillance

It is expected that when the surveillance system will installed, the vandals will shy away from tampering the tower bracings. So many vandals have gone court free as they have been no evidence. However, by use of this method, when the vandals are caught, evidence will be there and they will have to face

the full wrath of the law. It is worth noting that the method is only viable where the vandalism is rampant hence does not have to be installed on all the transmission towers and survey steel bracing 24/7

### III. COST INCURRED TO REPLACE VANDALIZED TOWER

Table II depicts the cost incurred in replacing vandalized tower every time teams carry out the exercise. From the table, if ten towers are vandalized it mount to Kenya Shilling two millions.

TABLE I  
COST OF REPLACING A TYPICAL VANDALIZED TOWER

No.	Item particulars	Quantity	Cost per item	Estimated Total Cost
1	Average length of vandalized bracings	160m	300	48,000
2	Labour and transport	-	-	100,000
3	Materials such as bolts, grinder, fuel etc			30,000
4	Overtime and call out			45,000
<b>Grand estimated Total cost (Ksh)</b>				<b>223,000 /=</b>

When a tower collapses due to vandalism of steel bracings, the costs escalate as shown in table II below.

TABLE II  
COST OF ERECTING A COLLAPSED VANDALIZED TOWER

No.	Item particulars	Quantity	Cost per item	Estimated Total Cost
1	Average length of replaced bracings	175m	300	52,500
2	Labour and transport	-	-	300,000
3	Materials such as bolts, grinder, fuel etc			70,000
4	Overtime and call out			125,000
5	Crane charges	6 hours	50,000	300,000
6	Loss of units sale	335,000	8	2,680,000
<b>Grand estimated Total cost (Ksh)</b>				<b>3,527,500/=</b>

The cost of replacing the vandalized tower bracings is

usually high as it mainly consist of replacing bracings, transportation of both materials and labor, hiring the equipment to erect the tower and compensation of cropped damaged during erection if the tower collapse where there are flora. The table I depicts the estimated cost incurred to replace a vandalized tower and table II depicts estimated cost incurred to erect a collapsed tower.

From table II, the cost of erecting a tower is usually very high. It is worth noting that during the time the line is off, the company may opt to load shed some loads if the unaffected lines have no capacity to carry addition power. It's imperative to ensure such incidences do not occur at any transmission line. For this reason, any project which can reduce or eliminate this menace is worthy implementing.

#### IV. CONCLUSIONS AND RECOMMENDATIONS

- a) A tower is one of the single most expensive components in transmission line and therefore need to be secured to maintain the transmission lines up from ground level.
- b) Most of Kenya power High Voltage transmission lines are supported by steel lattice towers which are either self-supporting or guyed type.
- c) However, these towers are vulnerable to collapsing because of vandalism of steel bracings which is currently very rampant at some parts of the country.
- d) Due to high cost incurred to replace the vandalized bracings and carrying out ground and aerial patrol, there is need to install an surveillance system that monitor the lattice towers 24/7.
- e) In this regards, the proposed system is expected to reduce the steel bracings vandalism hence securing the lattice towers. The system will reduce mileage as any tower installed with the system will alert the management in case there was any an attempt of vandalism of steel bracings.
- f) It is expected that vandalism of steel bracings will decrease drastically and the cost incurred to patrol and erect a collapsed towers will be eliminated.
- g) It is therefore recommended to have a pilot project on a few selected transmission lines before implemented in other most vulnerable transmission lines country wide.

#### REFERENCES

- [1] Turan Gonen, 'Electrical Power Transmission System Engineering Analysis And Design', 2 ed, 2009.
- [2] A Jesumi et, 'Optimal Bracing system for steel towers,' IJER&A Vol.3 Issue 2, 2013 pp 729-732
- [3] Omata, 'Steel tower surveillance system manual' 2014
- [4] KPLC standard code of practice on transmission line maintenance



# Development of Aids to Navigation Information System: A Case Study of Kenya Coast Waters

Magdalene Wanjagi Njuki and Moses Murimi Ngigi

**Abstract-** Aids to Navigation is an information service facility which is set up to help sea fairing vessels sail safely, economically and expediently by its visual, sound and wireless signals. In Kenya the marine safety along the coast has deteriorated gradually due to destruction, obstructions and lack of Aids to Navigation. Navigation charts, which are the basic Aids to Navigation, are still in analogue paper format, making them cumbersome and inefficient for use on board the marine vessels. The aim of this research study was to develop web-based Aids to Navigation Information System for the Kenya's coastal waters. All the published nautical charts covering the coastline and survey plans were used. ArcGIS software was used to digitize and create spatial and non-spatial attributes of the existing Aids to Navigation. PostGIS for PostgreSQL 9.2 was used as a relational database management system where PgAdmin III was used to host the database. Macromedia Dreamweaver 8 was used to develop the web interface. Bitnami WAMPstack was used to host the web interface in the local computer. Mobile application for the system was developed and hosted by Net beans IDE 7.0. A spatial database, user interface and a mobile application were the results of the development. The research also brought into revelation that most of the physical aids to navigations (beacons and lighthouses) were not functional due to obstruction by built-up developments along the coastline. The developed system facilitates easy updates, maintenance and monitoring of aids to navigation. There is need for integration of the Aids to Navigation System with Automatic Identification System (AIS) for effective marine navigation.

**Keywords:** Aids to Navigation, GIS, marine navigation, navigation charts.

## I. INTRODUCTION

The use of the oceans is becoming more intensive as a result of the increase in maritime transport and other uses, such as offshore exploration and the exploitation of traditional and renewable energy sources, fishing and tourism. In more crowded seas, with greater traffic density and larger ships, shipping routes will need to be supported by better and clearer information systems such as hydrographic services, Aids to Navigation and technology such as Vessel Traffic Services (VTS), Global Maritime Distress and Safety System (GMDSS)

and satellite communication technology for vessels to achieve the required efficiency while enhancing safety [1].

Aids to Navigation are devices or systems, external to a vessel, which are provided to assist mariners in their determining position and course, to warn of dangers, obstructions or to advice of the location of the best or preferred [2].

According to [3] the safety of navigation has been enhanced by the introduction and use of modern technology to improve safety of shipping in Malacca and Singapore Straits and reduce the risk of pollution of the marine environment. The technology has influenced the safety of navigation of a vessel through availability of accurate information to determine the position of the vessel at any given time.

The integration of AIS, VTS, DGPS and other application systems can be realized through GIS information platform to achieve the visual maintenance and management, spatial and model analysis which can be used to construct a variety of waterway models and application models for analysis, of Aids to Navigation [4].

The marine safety along the coast has deteriorated gradually due to destruction and lack of Aids to Navigation. The cost of any marine incidents is potentially significant and likely to impact on trade, tourism and the environment of a given coastal country.

Navigation charts which are the basic Aids to (AtoN) which every master is supposed to have on board his ship as he navigates in the specific sea area, in order to avoid any hazards of navigation are in analogue format thus making it hard for use on board. The shipping industry seeks efficiency and safety. Poorly charted areas and lack of relevant information will cause voyages to be longer than necessary, and may prevent the optimum loading of ships, thus increasing overall costs.

The main objective of the study is to develop a web based Aids to Navigation Information System to serve the Kenyan Coast waters. The Specific objectives of the research will be to document and map the existing Aids to Navigation, design a database for the Aids to Navigation and create a web interface

to link the database, and lastly propose strategies for securing the existing Aids to Navigation.

The study area is the Kenyan coast waters which mostly serves the Kenyan ports.

In Kenya the coverage of the charts starts from sheet number 3362 Lamu to Kismaayo at the Somalia border to sheet

number 3310 Mafia Island to Pemba Island at the Tanzania border as shown in Fig.1.

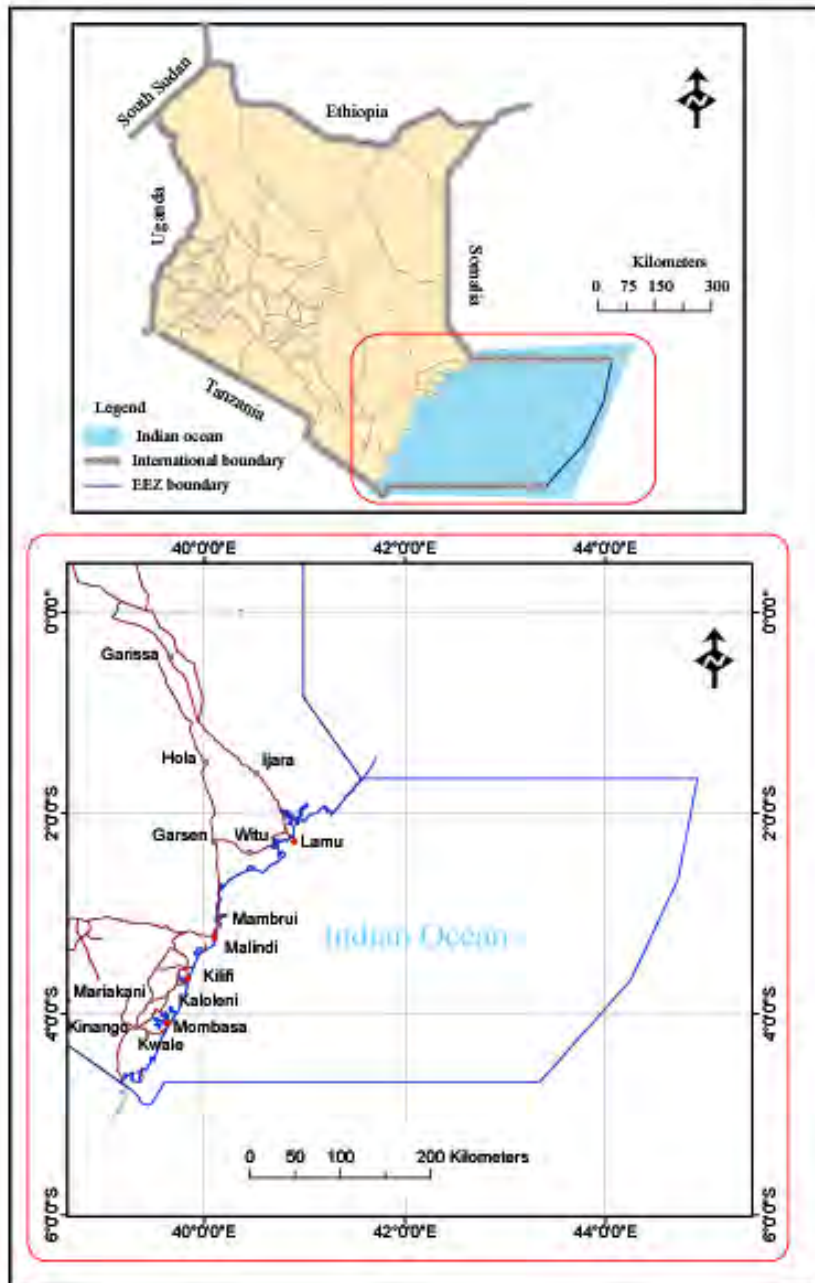

Fig 1 Kenya coastline

## II. PAPER OUTLINE

The whole research entailed the following steps; definition of the problem, formulation of the objectives, justification of the research, data collection, system creation and testing, results and discussions, conclusions and recommendations.

## III. METHODOLOGY

The research objectives formulated were achieved by undertaking the following steps; data collection, data processing, system development and testing as shown in Fig.2.

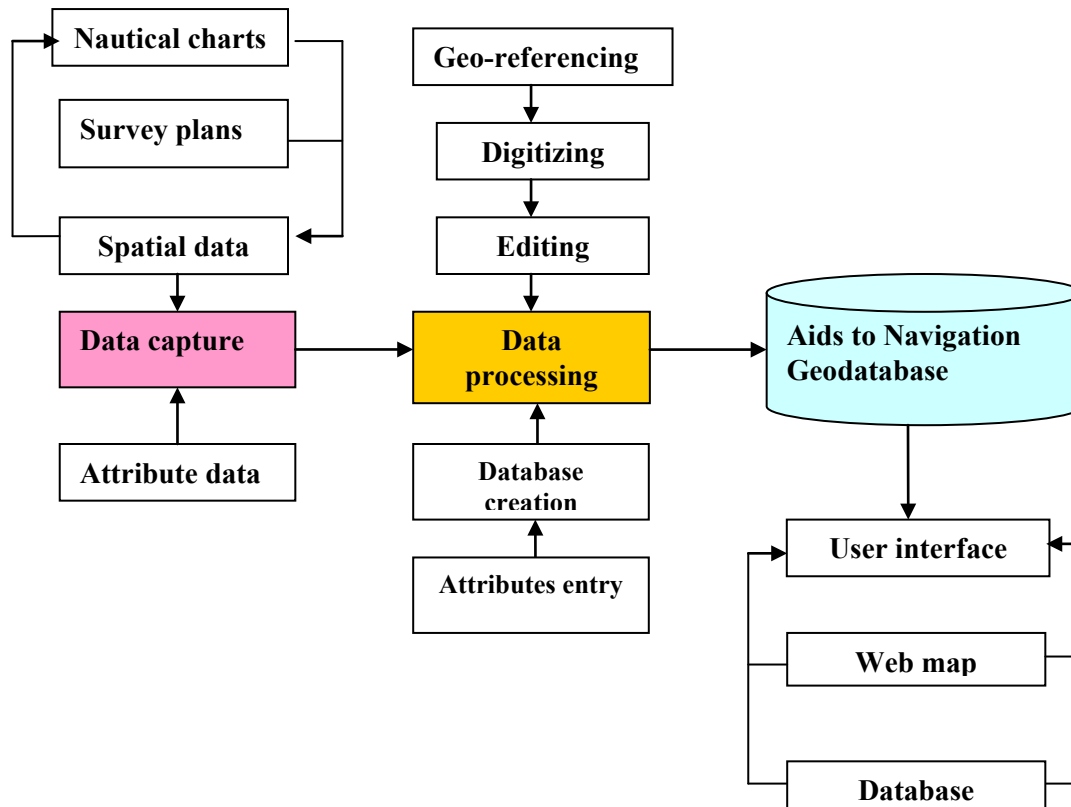

Fig. 2 Methodology

Table 1 List of data

Data	Format	Source
Fr 314/20	Scanned copy	Survey of Kenya
Fr 229/100	Scanned copy	Survey of Kenya
Fr 322/176	Scanned copy	Survey of Kenya
Nautical chart no.668	Scanned copy	Survey of Kenya
Nautical chart no.616	Scanned copy	Survey of Kenya
Nautical chart no.238	Shapefiles	Survey of Kenya
Nautical chart no.3361	Shapefiles	Survey of Kenya

### A. Database creation

PostGIS for postgresSQL 9.2 was used as a relational database management system. PgAdmin III was used to host the database. A new database was created in Gamin III named Aids\_to\_navigation1 and the shapefiles were imported .The various properties i.e. primary key, foreign key for tables were set. In Gamin all the tables' details could be viewed as well as be queried.

### B. Developing the web interface

Dreamweaver 8 was used to develop the web interface. Dreamweaver supports various coding like Php which is an Object Oriented Programing language and CSS (Cascading style sheet) was used to add styles to the interface. After coding Bitnami WAMPstack hosted the web interface in the local computer (localhost). To login one must be registered so

as to have the password and username. The web interface also allows login by several users as shown in Fig.3. This regulates the access to the information and to what extent.

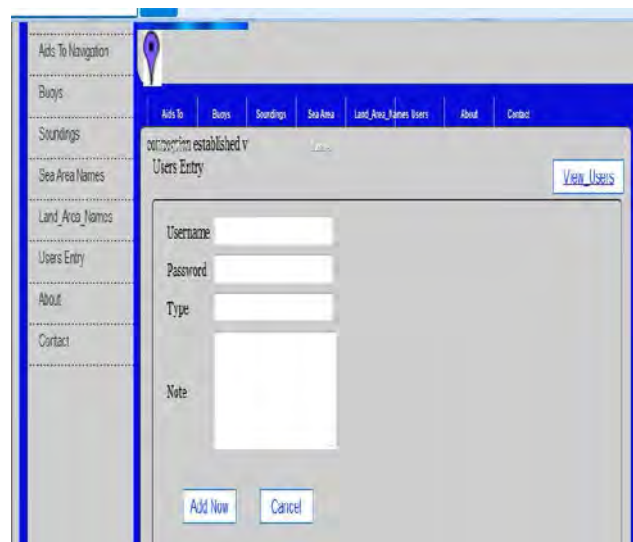

**Fig. 3** User entry dialog box

### C. Mobile application

Mobile application for the system was developed and hosted by Net beans IDE 7.0 which runs in a java platform. Net Beans is an Integrated Development Environment (IDE) written in Java that supports development of Java programs and web services. An IDE project was created named Navigation and coding done in Java programming language supported by Java SE Development Kit (JDK7). Using the mobile phone one can access the system created and view all information. Mariners can also track their position while in the sea and confirm they route.

## IV. RESULTS AND DISCUSSION

### A. Aids to navigation map

A map showing beacons and buoys was produced. The buoys define the navigation channel. General lights as well as leading lights are incorporated in the map as they guide the mariner on board. The map shows aids to navigation along Lamu bay as shown in Fig.4.

### B. Aids to Navigation Database

A spatial database was created in PostGIS for postgresQL 9.2. The database created provides the mariner with every detail of a specific Aid to Navigation which is type of aid, colour, structure, colour of light, longitude and latitude as shown in Fig.5.

### C. Current status of aids to navigation

It was discovered that three beacons and lighthouses are not functional as a result of obstruction. Private developers have grapped most the parcels hosting Aids to Navigation. The

present Aids to Navigation is mostly passed through publications of Notices to mariners and use of paper charts. he Aids to Navigation affected were leading lights FL2s16m3m obelisk BW , Q. 11m3m obelisk BW and directional light ISO WRG.5S21m2m (12) obelisk W all in chart No 666 Port Mombasa including Kilindini and Reitz as shown in Fig .6. The parcels obstructing the three Aids to navigation are; Plot MSI/MSA/1817 blocking the Direction Light with coordinates 39°40'5.9546"E4°05'0.4054"S.PlotsMSA/1789,1790,1791,1792,1793,1794,1795,1796,1797,1814,1818,1819,1820,1821,1822,1824,1825,1826, 1828, 1829, 1830, 1831 have walls which block the two leading lights.

### D. User interface

A user interface was created by Apache PHP and hosted by Bitnami WAMPstack which is open source software.The interface is web based and can be accessed in any browsers.

### E. System access

To access the system created in the localhost one must be authorized by the administrator. One must have the user name and password (Fig 7). The system can be accessed on any web browser through the link .While logged to the system one can only view the information about aids to navigation and the maps.

**Fig. 7** User login dialog box in PHPMyAdmin

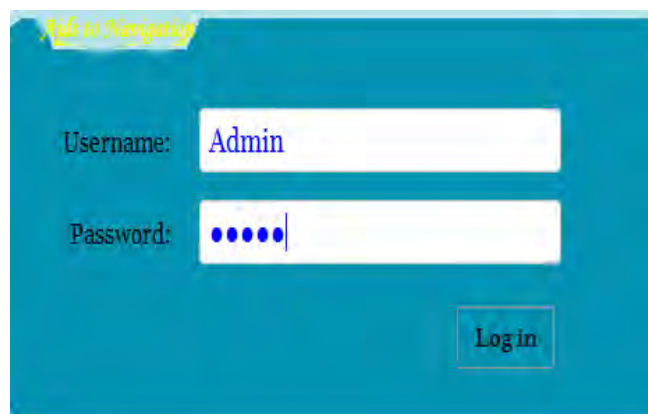

### F. Data access and retrieval

Users logged to the interface can access the database created. Several maps equivalent to the tables can also be accessed on the web browser. The map created guides mariner to track his/her route while Navigating.It is also possible to overlay the created maps to google earth maps. The buoys have designed colours which the mariners understand their meaning.It also shows the position for the Mariner to determine position in reference to the channel.

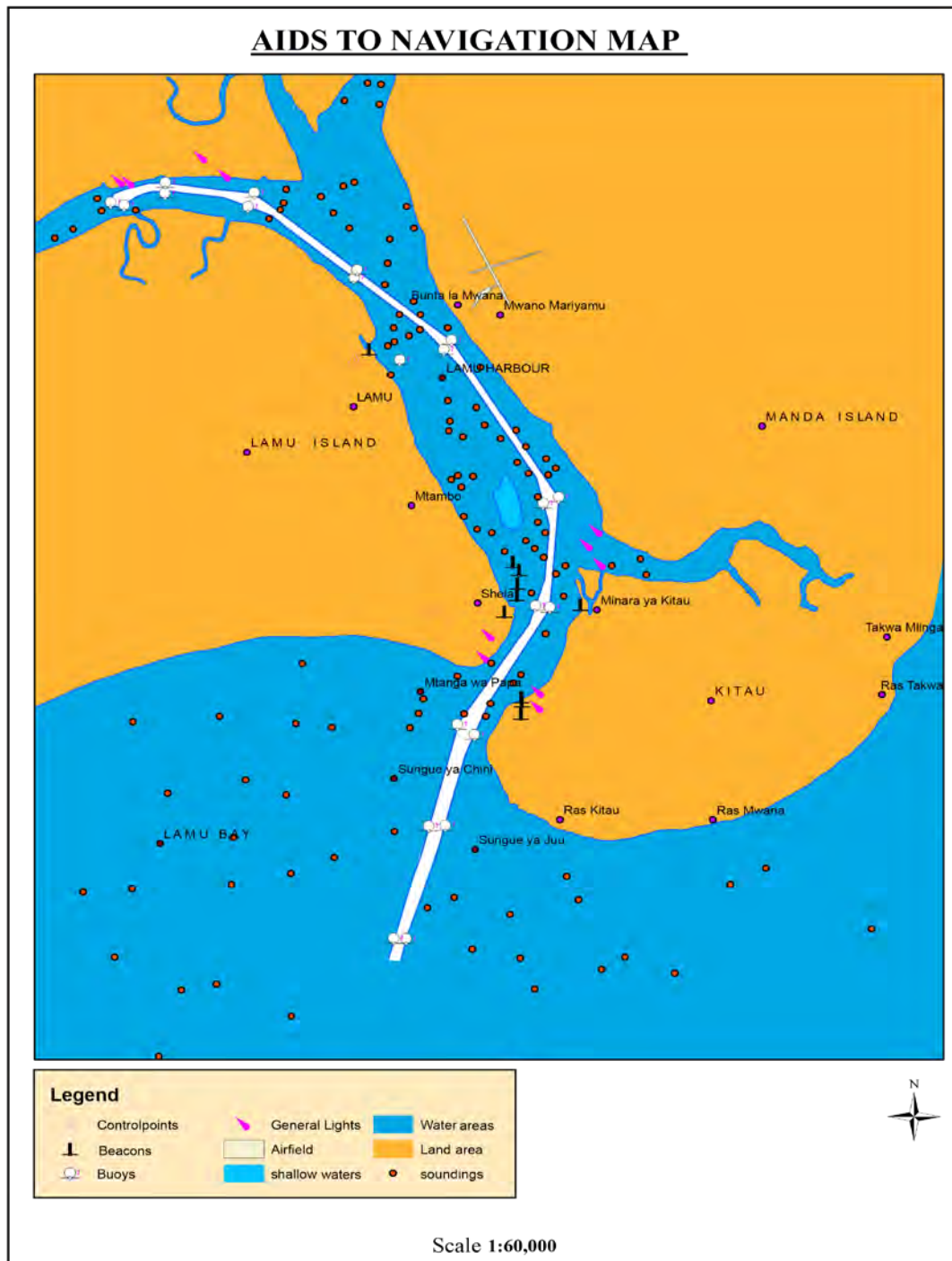

**Fig. 4.** Aids to Navigation Map

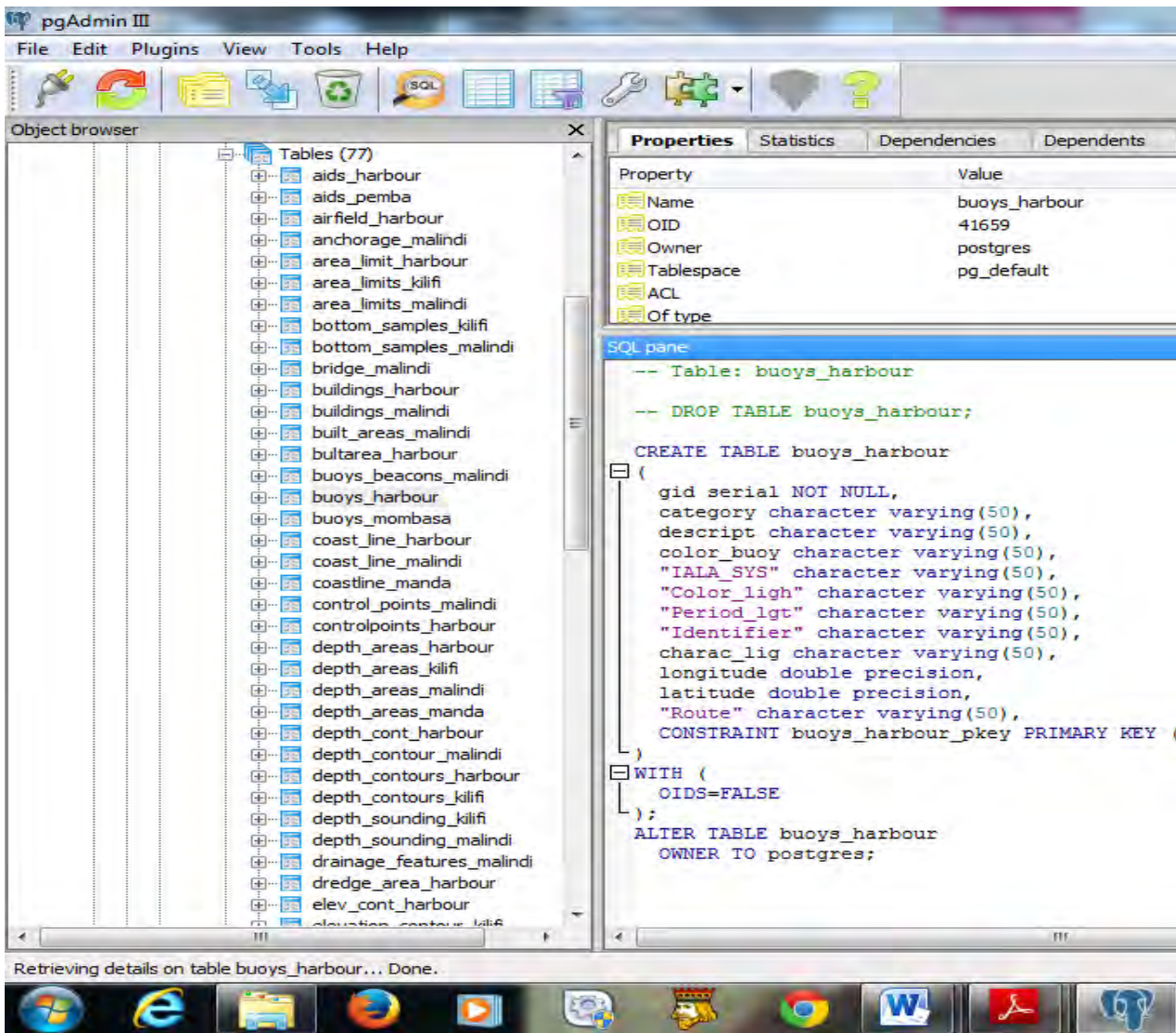

Fig. 5 An overview of the Aids to Navigation database created, showing a list of tables

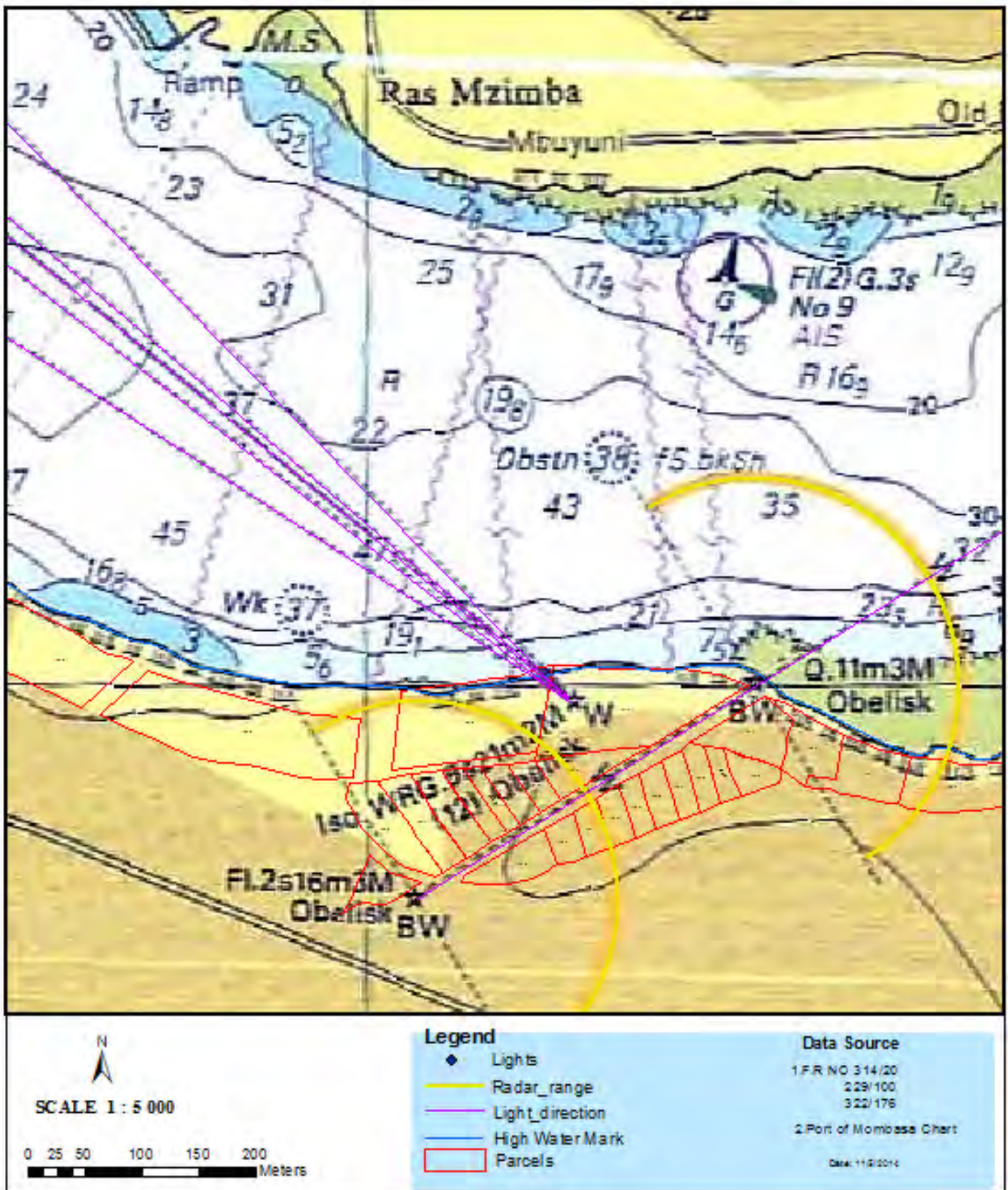

Fig. 6 Navigation chart-cadastral overlay of Kilindini harbour

### *G. Mobile application*

A GPS mobile capability was developed. This is an application whereby a mariners access the application developed on mobile phone which is java enabled and with GPS applications. From the phone it was possible to track one's position by show of longitudes and latitudes. It was also possible to access the database and the map on phone

## V. CONCLUSION

The research study sought to address the problem of how information on aids to navigation is gathered and disseminated to the appropriate users and organisations. From the research an aids to navigation map of Lamu harbour was created which shows a navigation channel.

An information system was developed composed of a spatial, a user interface and a mobile application. How to login and access the system as well as retrieve the information are also demonstrated.

The research also leads to discovery of aids to navigation which have been obstructed by developments. The parcels where these aids to navigation lies were also identified.

From the study one draw conclusions that the system should be adopted for effective management, data and information dissemination to the appropriate bodies about Aids to Navigation to enhance safety at the sea. Generally the system will enhance marine navigation.

## ACKNOWLEDGEMENT

Magdalene thanks Dr.Murimi for his guidance and endless efforts offered amidst his busy schedule of activities.

## References

- [1] International Hydrographic Office (IHO). (2011), publication M-2 version 3.
- [2] Canadian Coast Guard Fisheries. (2012).The Canadian Aids to Navigation System. Aids to Navigation Program.
- [3] Neil, G., & Torsten, K. (1999). Application of New Generation Navigational Aids and Aids to Navigation in the Malacca and Singapore Straits.
- [4] Haigang, S., Jinghwan, X., Jialu, C., & Wenjuan, M. (2008). Discussion on 3d Aids toNavigation planning and setting based on GIS and VR.



# Assessment of the Safety and Health Hazards in Existing Dumpsites in Kenya

Mugo K.K, Gichanga J.M, Gatebe E. and Njogu P.M.

**Abstract**—Environmental pollution from uncontrolled solid waste disposal is of major concern and generates chemicals or pollutants that reach their surroundings, such as soil, groundwater resources, and even the ambient air, because of environmentally unacceptable disposal or failure of lining system in the dumpsites. The increasing amount of municipal solid waste (MSW) emanating from residential, commercial and industrial areas, together with changing nature of waste over time, have led to the degradation of the quality of the environment. In the interest of inter-generational equity, today's dumpsites should not leave a negative environmental legacy for future generations to address. Furthermore, for as long as dumpsites remain part of our waste management strategy, best practice measures must be adopted to ensure that they are managed acceptably. The study focused on three dumpsites in Kenya; the Nakuru dumpsite in Nakuru county, the Nyeri dumpsite in Nyeri county and the Ngong' dumpsite in Nairobi county. The approach was to conceptualize the problem of solid waste disposal problem in Kenya within the mainstream environmental discourse. The study used interviews and observation, focus group discussions and participatory rural appraisal.

**Keywords**—Environment; Health; Waste.

## I. INTRODUCTION

THE accelerated growth of urban population, increasing economic activities and lack of training in modern solid waste management practices in the developing countries complicate efforts to improve this service sector. Although the urban residents of the developing countries produce less solid waste per capita than the high-income countries, the capacity of the cities to collect, process or reuse and dispose solid waste is limited [1].

The processes of storage, collection, transport, treatment and disposal of wastes all have the potential of environment risk [2]. Major advances in the development of new materials and chemicals have increased the diversity and complexity of the waste streams. Consequently, wastes are taking on a new economic importance, not only in terms of revenues generated by the waste treatment and disposal industry, but also because wastes may have a residual value as a secondary raw material which can be recovered or reused.

In solid waste management, environmental and health risks can be minimized by making waste technologies more

contained, reducing contaminant emissions, changing working methods, use of protective clothing, and keeping the public and residents a safe distance away from operations. For example, risk of respiratory infection or allergic response to organic dust can be greatly reduced if transfer stations, composting and recycling process systems are enclosed or ventilated and if workers wear respiratory masks [3].

A study carried out in the USA on increased coronary disease events showed that solid waste workers had two times more risk than the country's general laborers. Because of inadequate understanding of the magnitude of the problem and poor financial resources, the risks are still largely unmanaged in most developing countries [5,6].

People living and working in the vicinity of solid waste processing and disposal facilities are also exposed to environmental health and accident risks. These risks relate to the emissions from the solid wastes, the pollution control measures used to manage these emissions, and the overall safety of the facility [5]. As with occupational risks, these risks are being substantially managed in high-income countries, but are still largely unmanaged in most developing countries.

Pollution control costs money and adherence to safe design standards requires a commitment to construction and operation supervision. External financial assistance is needed to support poor countries in their environmental efforts, even though solid waste projects have proven to be more time-consuming to prepare and implement than most urban infrastructure improvements. Solid waste management is an important part of the urban infrastructure that ensures the protection of environment and human health [7].

Falora et al acknowledged that key environmental problems facing human settlements in both urban and rural areas are mainly tied to urbanization [8]. These include among others poor solid waste management, lack of sound legal framework to govern environmental management and failure to enforce existing environmental status by relevant public agencies and lack of community participation in environmental management.

Fobil et al pointed out that poorly dumped and uncontrolled waste degrades urban environment, discourages efforts to keep streets and open spaces in clean and attractive conditions leading to reduced aesthetic appearance and bad smells [8]. Uncontrolled waste often ends up in drains leading to blockage of drainage channels resulting to floods and unsanitary conditions.

Since the mid-1980s municipal solid waste and the environmental consequences associated with its management have received a great deal of attention in industrialized

Mugo K.K, Institute of Energy and Environmental Technology (IET), Jomo Kenyatta University of Agriculture and technology (JKUAT) (: +254722373642; e-mail: [kkamumbu@yahoo.com](mailto:kkamumbu@yahoo.com))

Gichanga J.M Department of chemistry, JKUAT (e-mail: [jamesmuraya13@gmail.com](mailto:jamesmuraya13@gmail.com);

Gatebe E, Department of chemistry, JKUAT ([erastusgatebe@yahoo.com](mailto:erastusgatebe@yahoo.com)); Njogu P.M, IET, JKUAT ([njogupl@yahoo.com](mailto:njogupl@yahoo.com)).

countries [9]. Research into the environmental effects of waste management practices has shown that the 'preferred' option(s) for waste management depends upon a number of site specific factors, including: characteristics of the waste, efficiency of the waste collection and processing systems required by different waste management practices, availability and proximity of markets for recovered materials, end use of the materials, recovered from the waste stream, emission standards to which waste management facilities are designed and operated, cost effectiveness of the environmental, protection obtained by different waste management practices and the social preferences of the community [10].

The decomposition of waste into constituent chemicals is a common source of local environmental pollution. This problem is especially acute in developing nations with very few existing dumpsites meeting acceptable environmental standards [11]. As land becomes scarce, human settlements encroach upon dumpsites space, and governments in some cases encourage new development directly on top of recently closed dumpsites.

In Kenya, the environmental management and co-ordination act, of 1999 provides a legal and institutional framework for the management of the environmental related matters, it is the framework law of environment which was enacted on the 14<sup>th</sup> of January 1999 and its implementation commenced in January 2002. County governments are charged with the responsibility of collecting and disposing of wastes within their areas of jurisdiction. The waste management issue in Kenya is as a result of many interconnected factors. Inadequate infrastructural waste management facilities such as treatment and disposal infrastructure, unreliable and irregular waste collection patterns lead to littering and physical accumulation of solid waste. The absence of modern waste management facilities such as sanitary landfills has left open dumping as the only means of disposal for solid waste. Lack of garbage segregation at the source worsens the situation. This poses great risks to human health while reducing recycling potentials to generate by-products. Solid waste has become a public irritant due to emission of foul smell and presence of scavengers and rodents. It damages the aesthetic value of the affected areas and reducing properties value.

County governments have a role in the set-up and operation of waste management systems. Most urban authorities in both industrialized and developing countries receive their powers and obligations from a central government authority, with allocation of powers and responsibilities to protect the rights of the citizens, to provide services, and to serve the common good [12].

## II. STUDY AREA

The Nyeri, Ngong' and Nakuru dumpsites situated in the Nyeri, Nairobi and Nakuru county respectively were selected for the study. The Nyeri dumpsite serves the town of Nyeri and its located three kilometers from the town centre. The Ngong' dumpsite serves part of Nairobi, the capital city of Kenya although it still gets some waste from the nearby

Kiambu and Kajjido counties. The Nakuru dumpsite serves Nakuru town and its environs.

## III. METHODOLOGY

The study implemented a case study research design. Data for this study was collected from a wide variety of sources to present a description of the phenomenon or the experience from the perspectives of the respondents. Instruments used included a questionnaire guide, an interview guide and a field observation guide. The questionnaire contained both closed ended and open ended questions in order to solicit information. Risk assessment included investigation of the relative effectiveness of different control measures in reducing exposure to safe levels.

## IV. RESULTS AND DISCUSSIONS

In all three dumpsites studied waste was found indiscriminately dumped on the ground surface, without any compaction effort and all the waste piles had undergone some degree of heavy burning as a result of no soil cover, the long dry season, and random fires. Field observation revealed that waste disposal was not confined to any one location. The sites survey indicated that accessibility problems during the rainy season had necessitated the need for alternate illegal disposal areas. Disposal sites were not being covered and there was no proper control of contaminated leachate.

Workers wore no protective gear not even gloves and face masks. Waste pickers in sites were not being managed. To complicate the exposure risk to workers and pickers, their personal hygiene was often inadequate. Washing facilities were not typically provided for use at the work place for clean up before going home (often by public transportation). In addition there was inadequate education on hygiene and health relations among the workers. Majority had no post primary education (Figure 2) and a significant number were illiterate with no formal education.



Fig. 1 Knowledge of waste handlers' on use of protective and preventive equipment (PPE)

Dumpsite waste pickers in all three dumpsites revealed that 55% did not use soap to wash their hands; 63% did not use soap to wash their feet; and more than 39% did not change their clothing daily. About 7% regularly waited more than a week between baths and changing clothes. In waste picking,

women reported preparing meals immediately after returning home from waste picking, without washing.

Respondents indicated that the health issues of concern varied by activity. Noise related hearing loss, hand arm vibration, manual handling and exposure to airborne were identified as major issues by several operators. One respondent was concerned about age-related impacts on musculoskeletal fitness, the development of age-related arthritis and age related deterioration in hearing / vision in employees with an average age of about 50 and about 10 years employment in the industry.

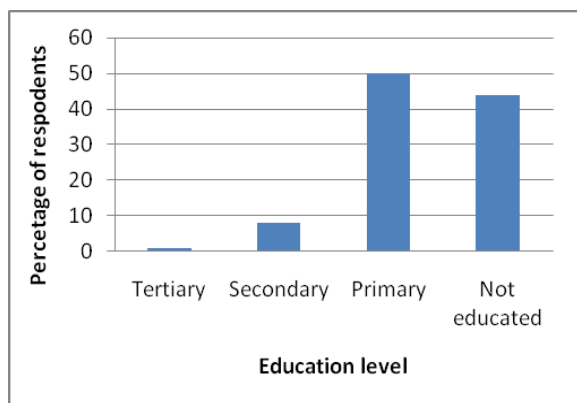

Fig. 2. Education level of waste handlers.

Exposure to skin contaminants in workshops and carcinogens, sensitizers and other toxic substances in hazardous waste were identified as issues by individual respondents. Safety and health issues were even complicated by acknowledgement of lack of knowledge on PPE by waste handlers (Figure 1).

91% of nearby residents and 54% of those living far from dumpsite thought their health was affected by the location of dumpsite. They also use the stream for washing clothes and bathing their children. These activities expose these residents to wastes particularly hazardous wastes which can lead to various diseases through chemical exposure. Household residents, especially those who are closer to the dumpsite were not happy about the location of the dumpsite in their community. They complained that the dumpsite is too close to their residencies causing them a lot of sicknesses. Furthermore, they argued that their surroundings were smelly and filthy and some of the wastes from the dumpsite get scattered near their houses causing pollution in the environment. All the respondents indicated that no measures are taken up to make sure that the community, at large, is protected from the dumpsite. Lack of protection from dumpsite related effects was worst because of low knowledge on pollution. Majority of residents who lived either close by or further away from the dumpsites indicated they knew nothing about pollution. A small percentage of them indicated that pollution causes sickness. Therefore, the residents suggested that among many other options, the dumpsite should be relocated as an interim measure.

None of the questionnaire respondents indicated that work related stress was of concern, despite its importance in the

wider workforce. The information provided by respondents about shift working and the requirement to undertake repetitive tasks suggested that factors associated with increased risks of stress such as repetitive tasks, changing shift patterns and limited or no control on work speed may be an issue at a minority of dumpsites.

## V. CONCLUSIONS

Exposure to waste handling sites is likely to give rise to significantly increased risks of chronic respiratory illness. It is likely that exposure to dust and bioaerosol in substantial proportion at composting sites exceeded the thresholds for the development of chronic (and disabling) respiratory illness. Small quantities of biological material are present in most wastes, giving rise to a potential for exposure to bioaerosol. Storage of organic-rich wastes, including untreated MSW, greatly increases the potential for bioaerosol emissions. Occasional exposure to significant infection risks or hazardous substances such as asbestos may occur wherever workers are in close contact with wastes on picking lines or during cleaning and maintenance operations involving untreated or partially treated wastes causing most risk. Provided workers use appropriate PPE and there are well established procedures in place to handle high risk incidents, the risk to worker health should be small.

It is difficult to develop alternative technology for total elimination of hazardous wastes generation. In developing countries, the thrust on economic development is often given priority to production costs than the best available technology that minimize wastes generation. The cost of treatment and disposal of such wastes becomes a liability on the society.

In spite of the environmental and health knowledge available, development of proper waste handling techniques has not taken place at the desired pace. As in other sectors of development where private ventures are entering in a big way, waste management, treatment and disposal programmes offer a good scope for private entrepreneurs to benefit with this sector of development. This will not only enable a facility provider to sustain his industry with profit but also the society will be benefited from these developmental activities in terms of getting cleaner environment and employment.

## REFERENCES

- [1] P. T. Nguyen, et al., "Assessment of Plastics Waste Generation and Its Potential Recycling of Household Waste in Can Tho City, Vietnam," *Environmental Monitoring and Assessment*, Vol. 175, No. 1-4, 2011, pp. 23-35.
- [2] R. A. Frosch, "Toward the End of Waste: Reflections on a New Ecology for Industry," *Daedalus*, Vol. 125, No. 3, 1996, pp. 199-212.
- [3] United Nations Environment Program Agency (UNEP), "Informal Solid Waste Management," 2006. <http://www.unep.org/PDF/Kenyawastemngntsector/chapter1.pdf>
- [4] J. A. Nwanta and E. Ezenduka, "Analysis of Nsukka Metropolitan Abattoir Solid Waste in South Eastern Nigeria: Public Health Implications," *Archives of Environmental and Occupational Health*, Vol. 65, No. 1, 2010, pp. 21- 26.
- [5] K. O. Boardi and M. Kuitunen, "Environmental and Health Impacts of Household Solid Waste Handling and Disposal Practices in the Third World Cities: The Case of Accra Metropolitan Area, Ghana," *Journal of Environmental Health*, Vol. 68, No. 4, 2005, pp. 34-36.

- [6] F. Forastiera, et al., "Health Impact Assessment of Waste Management Facilities in Three European Countries," *Environmental Health*, Vol. 10, 2011, p. 53.
- [7] Fobil, J.N., Carboo, D. and Clement, C. (2002) 'Defining options for integrated management of municipal solid waste in large cities of low-income economies: the case of the Accra metropolis in Ghana', *The Journal of Solid Waste Technology and Management*, Vol. 12, No. 8, pp.106–117.
- [8] Falola, T. and Salm, S.J. (Eds.): *Globalization and Urbanization in Africa*, Africa World Press, Trenton, NJ, pp.249–269.
- [9] E. Marshal, "Analytical Study to Evaluate Associations between Dumpsites and Birth Effects," ATSDR COLTD, Atlanta, 1995.
- [10] Medina, M. (2002). *Globalisation, development and municipal solid waste management in Third World Cities*. Tijuana, Mexico: El Colegio de la Frontera Norte.
- [11] Renzoni, A. (1994). *Contaminants in the environment: a multidisciplinary assessment of the risk to a man and other organisms*. London: Lewis Publishers.
- [12] Yedla, S. and Parikh J.K. (2001) 'Economic evaluation of LFSGR for MSW management: a case study', *International Journal Environment and Pollution*, Vol. 15, No. 4, pp.433–447.

# Assessment of the Contribution of Recapitalization of Nigerian Banks to the Growth of Nigerian Real Sector

Idowu Akinyele A., Lawal, T.Tewogbola and Oyedokun, T.O

**Abstract**— In Nigeria, access to finance has been identified as a key element for Small and Medium Scale Enterprises to succeed in their drive to build productive capacity, compete, create jobs and contribute to poverty elimination in the country. Banks in Nigeria have been recapitalized and adopt necessary infrastructures (ICT) to enhance their performance and stimulate the real sector as catalysts of development. How effectively have they performed this function as a pivot around which economic development revolves? Without finance SMEs cannot acquire or absorb new technologies neither can they expand to compete in global market or even strike business linkages with larger firms. Despite this, SMEs have faced difficulties in obtaining formal credit or equity from the commercial banks. A regression of bank facilities to SMEs prior and after recapitalization with GDP showed a downward trend and eventual positive downward correlation movement in the main two variables. It was found that banks need to do more to assist the SMEs for effective performance than mere recapitalization.

## I. INTRODUCTION

IN Nigeria finance has been recognized as an essential tool for promoting Small and Medium Enterprises (SMEs). The federal and state governments in Nigeria have recognized that for sustainable growth and development the financial empowerment of the SMEs is vital, being the repository of the predominantly poor in society. An important role for banks to play is to design ways of providing loans to informationally opaque small business -Berger, Klapper, and Udell (2001).[1] However, a number of factors may affect the banking system's ability to provide credit to small borrowers. There is evidence of bank consolidation across many countries of the world through mergers and acquisitions. These mega banks may be oriented towards transaction (lending and providing capital markets services) to large corporate clients and often less quantitative and qualitative relationship with small business. Re-capitalization of banks in Nigeria is intended among others to help mobilize domestic savings, deepening and broadening intermediation, improve allocation of resources and helping to mobilize foreign savings.

Idowu, A. A., Department of Finance, JKUAT (idakinyele@gmail.com.+254 700760828).

Lawal, T. T., Department of Banking and Finance, The Federal Polytechnic, Ede, Nigeria.

Oyedokun, T. O., Department of Business Administration, The Federal Polytechnic, Ede, Nigeria.

Credit is the largest element of risk in the books of most banks and failures in the management of credit, risk, by some banks in some cases have weakened some individual banks and contributed, to many episodes of financial instability. An increasing amount of research on credit risk is being carried out within financial firms, central banks, regulators and universities. However, in most developing countries like Nigeria, manufacturing SMEs are operating in an environment with weak institutions for technical and financial supports - Oyeyinka, (2002).[2]. They face severe legal and regulatory constraints and little institutional, financial support is available for them for innovation. Hence, important technical affiliations, network capacity and ownership are crucial factors in the economic performance and innovative behavior of these industries in such an environment.

### A. Research Problem and Purpose

Despite recapitalization of Nigeria banking industry and consequent declaration of large profit by the banks the real sector had not really felt their impact. This paper intends to analyze the accessibility of SMEs to bank loan and to ascertain whether recapitalization offers an effective means of solving the problem of funding small and medium scale businesses in Nigeria, thereby determine the relationship between bank recapitalization, bank loan disbursement to SME and their contribution to GDP.

The objectives are:-

- i. To determine the effectiveness of banks in their role as economy stimulator; and
- ii. Whether the recapitalization improves loan disbursement to economic engine rooms – the SME's

Hypothesis:-

The study will investigate and hypothesis whether increased Bank Capital base facilitate loan facilities to SME

## II. LITERATURE REVIEW

Small businesses do not conform to any neat parameters because much of their activities depend on the industry in which they operate also the personalities and aspirations of those in charge of these businesses. These factors vary from manufacturers to retailers and high start-ups that are funded by venture capitalists to self-financed tradesmen and women

for the purpose of making a living. -David.S and Nicholas, (2006) [3].SMEs occupy a pride of place in virtually every country or state, they have aptly been referred to as the engine of growth and catalysts for socio-economic transformation of any country. SMEs represent a veritable vehicle for the achievement of national economic objectives of employment generation and poverty reduction at low investment cost as well as the development of entrepreneurial capabilities including indigenous technology. SMEs in Nigeria can be organized or unorganized enterprises. The organized enterprises have paid employees with a registered office while the unorganized enterprises are mainly made up of artisans who work in open spaces, or operate in temporary wooden workshop or structures, and mostly employ low rate or no salary paid workers. The major activity involved in this sector include; soap and detergents making, fabrics, textile and leather making, local blacksmith, tinsmith, ceramic, clothing and tailoring, timber and winning, bricks and cement, food processing, wood furniture, beverages, bakeries, electronic assembly, agro processing, chemical based products and mechanics (Sanni 2007) [4].

Financial systems, the world over, play fundamental roles in development and growth of the economy. Their effectiveness and efficiency in performing these roles, particularly the intermediation between the surplus and deficit units of the economy, depends largely on the level of development of the financial system. It is in order to ensure its soundness, that the financial sector appears to be the most regulated and controlled by the government and its agencies - Ogujiuba, Ohuche, Adenuga (2004)[5]. Stiglitz and Weis (1981)[6], observed that small and medium scale firms with opportunities to invest in positive net present value projects may be blocked from doing so because of adverse selection. Adverse selection problems arise when potential providers of external finance (banks) cannot readily verify whether the firms have access to quality projects. Nonetheless, the liquidity ratio of the financiers plays a major role. Through the new minimum capital requirement, the number of banks in the country has been successfully reduced, from eighty-nine to twenty-one. They are now more robust and efficient. They are, therefore, better placed now to meet the funding needs of their clients in SMEs. In the past, the financial intermediation role of the banks became heavily impaired while the macroeconomic activities seriously slowed down. It was against this background, that the Central Bank of Nigeria (CBN) announced a major reform of the Nigerian banking industry. The recapitalization of the capital base of banks constituted the first phase of the reform policy in the banking sector of the Nigerian economy. Recapitalization in Nigeria comes with amendment to the existing banking laws. In July 2004, The Governor of the CBN announced the need for banks to increase their capital base to N25 billion, and gave December 2005 as the deadline -Adegbaju A. and Olokoyo F,(2008)[7], with a view to providing verile banking system and support for economic growth and development.

In 2001, a study identified poor access to finance as the

most critical constraint on small and medium scale enterprises in Nigeria. In fact, 50 percent of the surveyed enterprises received external finance while 79 percent indicated lack of financial resources as a major constraint (see Guardian. Nov, 26, 2001) [8]. The foregoing study confirms the risk-averse behavior of banks in funding SMEs in Nigeria. Somoye & Ilo, (2009) [9],also discussed the impact of lending on bank performance. They pointed out that the Nigerian government, through the CBN, set the lending rate for financial intermediaries at their various prevailing levels in the banking industry. To buttress their argument, they argued that the CBN set the rate to favour specific sectors in order to encourage or discourage lending to preferred sector of the economy as the case may be. i.e the environmental factors also play a vital role in banks' lending behavior.

In recent years, banks in developed countries have launched a number of initiatives that both improve the profitability of lending to SMEs and also provide SMEs with better access to finance and to financial products that are better tailored to their needs (Aladekomo, 2003)[10]. A number of leading banks have demonstrated that providing financial services to SMEs can be turned into a highly profitable business. Although the business environments in developing countries and developed countries differ in many respects, the problems of servicing SME customers are similar, namely high-perceived risk, problems with information asymmetry and high administrative costs. Therefore, recent innovations in developed countries to improve SMEs access to credit can provide valuable insights for developing country banks to become more SME-oriented and to increase the volume and the quality of their services to this sector. Economic growth indices in Nigeria reflect the effective production capacities of SMEs not only on how they are funded, but the practical utilization of their operational philosophy and how this is integrated towards service delivery and uplifting society. As a result, several microlending institutions were established to enhance the development of SMEs. Such micro credit institutions include the Bank of Industry (BOI), National Economic Reconstruction Fund (Nerfund), the Nigeria Agricultural and Rural Development Bank (NACRDB), the Microfinance Bank (MFB), and the Nigerian Export and Import Bank (NEXIM), and the liberalization of the banking sector. Howbeit, up till 2005 the number of banks operating in the country is about 89 with more than 50% having capital base of less than US\$10 million and about 3,300 branches. This compared to 8 banks in South Korea with about 4,500 branches or bank in South Africa with larger assets than all the 89 banks. This shows that the banking system is very marginal, relative to its potentials and in comparison with other countries. -Ogujiuba, Ohuche, Adenuga (2004)[11].SMEs, of whatever configuration, are an asset in the production of chain economy, because of their impact on issues of job creation, provision of a wide provision of goods and services, income generation and efficient sources for micro-financing.

Despite their proactive nature, growth SMEs, have been

slighted, because of inadequate access to finance, production schedules and marketing. Due to the inability of SME's to raise their own finance and access financial services from formal sources (UNCTAD, 2001),[12]. The comfort is that the governments (local, state and federal) are neither relenting nor giving up in their bid to revamp and invigorate the fortunes of SMEs as to enable them play the expected role in Nigeria's economic growth and development. This is evidenced by the government's recent establishment of, as well as the, mandate given to the Bank of Industry (BOI) and the Small and Medium Enterprises Development Agency of Nigeria (SMEDAN), the facilitation of the Bankers' Committee's institutionalization of the Small and Medium Industries Equity Investment Scheme (SMIEIS), the federal government's drive and focus on realizing the objective of NEPAD, the government's endorsement and support of multilateral agencies and loans, and the government's backing of international development finance facilities such as the European Investment Bank (EIB) facilities and the likes. This undoubtedly is a reflection of the changes in the monetary policies of Nation. Given the crucial role SMEs play in the industrial and economic growth and development of developing countries like Nigeria, the various governments in Nigeria cannot afford to relax in their efforts towards making the SME subsector very vibrant and productive-Onugu, (2005),[13].

#### A. SMEs Experience in Accessing Financial Resources

This category of SMEs usually look to the banking sector and other financial intermediaries for instruments to finance working capital and to provide credit for short-term liquidity management. However, they often fail to access the financial resources in the required amounts because banks evaluate them on the basis of a checklist, as listed below:

- Audited finance statement for the last three years including management accounts;
- Project proposal highlighting strengths, weaknesses, opportunities and threats
- Financial projection
- Monitoring costs;
- Credit or default risk because of the problem of information asymmetry;
- Enforcement costs.

Unfortunately, financial and accounting records are rarely in place for most of these SMEs, and where they are available, their accuracy is usually doubtful. In instances where bank financing is provided, it is in most cases in amounts that are insufficient and at a high cost in relation to the term to maturity of loans. They also apply simple and relatively backward technology in production and, therefore, the quality of their products are usually poor. There is a general lack of professionalism within this category of SMEs in terms of strategic planning procedures, decision-making processes and business planning, and management in general -

Kasekende,(2001),[14].

#### B. Banks Position in Financing SMEs

Consequently, commercial banks and investors have been reluctant to service SMEs because:- (1) SMEs are regarded by creditors and investors as high-risk borrowers due to insufficient assets and low capitalization, vulnerability to market fluctuations and high mortality rates; (2) Information asymmetry arising from SMEs' lack of accounting records, inadequate financial statements or business plans makes it difficult for creditors and investors to assess the creditworthiness of potential SME proposals and (3) High administrative/transaction costs of lending or investing small amounts do not make SME financing a profitable business.

The absence of collateral or foolproof steps for its enforcement warrants special mention since it has been an important factor, inhibiting bank from lending to SMEs particularly as banks do not just rely on their borrowers' past financial statements or projected earnings as the bases for their credit decisions. As a result, commercial banks are generally biased toward large corporate borrowers, who provide better business plans, have credit ratings, more reliable financial information, better chances of success and higher profitability for the banks. When banks do lend to SMEs, they tend to charge them a commission for assuming risk and apply tougher screening measures, which drives up costs on all sides.

### III. RESEARCH METHODOLOGY

For the purpose of determining the relationship between Bank loan to the SMEs and its impact on the general economic development, secondary data was sourced from CBN statistical bulletin on: (i) Total Commercial Bank Loan, (ii) Loan to SMEs; and Gross Domestic Product (at current price). These are presented in Tables I & II i.e from 2000 to 2009, and the percentage composition in the pre-recapitalization era 2000-2004 was compared to post-recapitalization era (2005-2009) percentages and ratios were used for analysis and movement trend in the two period were compared.

### IV. FINDINGS AND DISCUSSIONS

A study of the figures in Tables I & II i.e. pre and post recapitalization periods respectively showed that though the volume of total credit and loan disbursement to SMEs improved in the post recapitalization era as expected but that was in absolute figure, when loan to SME is compared to total credit on percentages, the trend is falling. Loan disbursement to SMEs in the pre recapitalization era is better than the post consideration era. Lowest proportion was 3.62% in pre-recapitalization in year 2000 compare to lowest proportion on post recapitalization era of 0.72% in year 2009.

There was increase in GDP in the post-recapitalization era, but given the proportion of loan disbursement to SMEs within these two periods, how much of this increase in GDP

could be attributable to the contribution of SMEs. (economic growth engine)? Very small! Amazingly, the GDP itself is growing but the percentage growth is falling, more so after recapitalization, which means money is not flowing to where it is needed for real economic growth.

The results confirmed the risk-averse behavior of banks in funding SMEs in Nigeria after the recapitalization. The analysis of the access to credit market for small and medium

scale businesses in Nigeria has established two important facts: (i) macroeconomic instability and uncertainty in the business environment has forced banks to lend short to SMEs;

TABLE I  
PRE-CAPITALIZATION

Period	Commercial Banks Loans to SMEs	%tage Growth or Fall	Total Commercial Banks Loans	Commercial Banks Loans to SMEs as %tage of the Total Credit	GDP Index	%tage Growth of GDP
2000	44.54	-	508.30	8.76	4582	
2001	52.43	18	796.16	6.59	4725	3
2002	82.37	57	954.63	8.63	6912	46
2003	90.18	9	1210.03	7.45	8487	23
2004	55.00	-39	1519.24	3.62	11411	34

Source: CBN Statistical Bulletin

TABLE II  
POST RECAPITALIZATION

Period	Commercial Banks Loans to SMEs	%tage Growth or Fall	Total Commercial Banks Loans	Commercial Banks Loans to SMEs as % tage of the Total Credit	GDP Index	% tage Growth of GDP
2005	50.67	-7	1899.35	2.67	14572	27
2006	25.71	-49	2524.30	1.02	18566	27
2007	41.10	60	4803.49	0.85	20657	11
2008	76.56	86	27568.41	2.7	24296	18
2009	63.30	-17	35167.20	0.72	24712	2

Source: CBN Statistical Bulletin

(ii) such overdrafts and short term loans are made available at high interest rates of over 26% and they are also relatively heavily collateralised. In a situation in which SMEs are mainly dependent on bank loans, this situation could be dangerous. The implication is that many SMEs do not have access to bank loans with grave implications for their growth and general economic development.(Odedokun,1998)[15]

Despite efforts to encourage adequate fund flow to

SMEs, the result has not being enthusiastic; the margin of loan to SMEs during post consolidation era is falling, i.e the economic engine house is grinding down. The growth in GDP could be concluded to be majorly a contribution of trading and services sectors and not manufacturing or real sector (SMEs) where the bank could have concentrated after such a good recapitalization outing.



#### A. The Small and Medium Enterprises Equity Investment Scheme (SMEEIS)

The Small and Medium Enterprises Equity Investment Scheme facilitated by the CBN, was initiated by the Bankers' Committee (all the banks in Nigeria) as another means to funding small and medium scale enterprises in Nigeria. The scheme requires all banks to set aside 10 percent of their profit before tax annually for equity investment in small and medium enterprises. The scheme is to promote indigenous entrepreneurship, develop local technology, generate employment, facilitate the flow of funds from banks for the establishment of new, viable SMEs, ensure output expansion, re-distribute incomes and promote industrial linkages. The Scheme involves equity participation of banks in enterprises that they have appraised to be viable. The banks partner with the entrepreneurs for social and economic development.(CBN 2004)[16].

#### V. CONCLUSIONS AND POLICY RECOMMENDATIONS

Recapitalization has in no way persuaded banks to lend more to SMEs, if anything the bank are cost and risk implication conscious hence money seems to be diverted elsewhere, perhaps where they can generate returns quickly without minding the consequence on real sector growth it therefore behoves the Small and Medium Enterprises (SMEs) to improve their management systems and adopt modern management techniques if they are to benefit from the opportunities offered by the formal sector. They need to improve their financial records and accounting systems. Proper records need to be kept and maintained. The books of accounts have to be clear and should reflect a realistic picture of their operations and financial conditions. A good system and books of accounts are not only helpful to the banks; they are also crucial in managing and monitoring business as well as guiding tax authorities.

Well-functioning and sustainable mechanisms for SME financing require institution building and a market approach. Lending institutions must improve their ability to provide financial services to SMEs through commercial mechanisms that lower costs and minimize their risk exposure. Only in this way will financial institutions find SME lending to be more profitable, and thus be encouraged to construct lending programmes targeted at SMEs.(Meyer 1998)[17]

Part of the reluctance of banks to lend to SMEs is the banks' inability to properly evaluate the position of SMEs because of the lack of reliable financial information. Banks and regulator}' authorities at times demand more information than what is publicly made available or required. In addition financial analysts, rating agencies or business intelligence providers can generate additional information, which is available to creditors and investors, at additional cost.

#### REFERENCES

[1] F. L. Berger and Klapper, Udell. G. F. (2001). The ability of banks to lend to informationally Opaque Small Business, Federal Reserve Bank working paper, Washington D.C.

[2] B. Oyeyinka.-Oyelaran, (2002): Manufacturing response in a national system of innovation: evidence from the brewing firms in Nigeria. Discussion Paper Series of The United Nations University, Institute of New Technologies (INTECH). Accessed on May 2005 from <http://www.intech.unu.edu>.

[3] S David and Nicholas. (2006): Small Business Management & Entrepreneurship 5th Edition.

[4] O. Sanni, (2007): Small Scale Industry: Problems Of Establishing Small Business Enterprise In Nigeria Case Study: Alahtef Niperia Limited. An Unpublished dissertation submitted to the Department of Business Economics and Tourisms, Vassa Polytechnics,

[5] Ogujiuba, Ohuche, Adenuga (2004): Credit Availability to Small and Medium Scale Enterprises in Nigeria: Importance of New Capital Base for Banks -Background and Issues. Working Paper Series.

[6] J. Stiglitz. and A. Weiss, (1981): Credit Rationing in Markets with Imperfect Information. American Economic Review 71, 93-40

[7] A. Adegaju and Olokoyo F.(2008) Recapitalization and Banks' Performance: A Case Study of Nigerian Banks African Economic and Business Review Vol. 6 NO.1, Spring 2008. ISSN 1109-5609.

[8] R Feldman, (1997): Banks and a Big Change in Technology Called Credit Scoring. The Region Federal Reserve Bank of Minneapolis, September 19-25, Guardian Newspaper, Nov, 26, 2001.

[9] Somoye &. Ilo (2009): The impact of Macroeconomic Instability on Banking sector lending behavior in Nigeria. Journal of Money, Investment and banking. Issue 7 (online), available at [www.eurojournal.com](http://www.eurojournal.com).

[10] F. O. Aladekomo. (2003). "The Small and Medium Enterprises' (SME) Landscape: Environment, Government policies. Programmes, and Institutional support." A paper delivered at the two-day workshop on "Strategies for Operationalising Small and Medium Industries Equity Investment Scheme (SMIEIS) in Nigeria!" on 23 - 24 August, 2003, at WEMA Bank Training School. Oba Akran Avenue, Ikeja, Lagos, Nigeria.

[11] UNCTAD 2001: Survey of Good Practice in Public-Private Sector Dialogue. Enterprise Development Series, New York and Geneva: United Nations. [13] B. A.

[12] Onugu. (2005): Small and Medium Enterprises (SMEs) in Nigeria: Problems and Prospects. A Dissertation Submitted To The St. Clements University In Partial Fulfillment Of The Requirements For The Award Of The Degree of Doctor of Philosophy In Management

[13] L. Kasekende.(2001): Improving The Competitiveness Of SMEs In Developing Countries., UNITED NATIONS New York and Geneva,

[14] M. O. Odedokun, (1998): Effectiveness of Selective Credit Policies Alternative Framework of Evaluation World Development Vol. 16, pp. 120 - 122.

[15] CBN. (2004): "Progress Report on SMIEIS" Accessible from <http://www.cenbank.org>.

[16] L. J. Meyer (1998): On the Profitability and Cost of Relationship Lending Journal of Banking and Finance 22, 873-897

# Design of Solar Energy Solution and Payback Scheme for Domestic Households.

Kara R N, Kibet Y D, Muriithi C M

**Abstract**— Kenya has tremendous potential for solar energy due to its proximity to the Equator. The country receives an estimated 4 to 6 kWh per square meter per day of solar insolation. Solar energy can therefore be harnessed to meet the energy demands of this growing nation while protecting its environment. This paper proposes a solar household system for domestic households in Kenya with a monthly energy consumption of 200kWh to 400kWh. This system is implemented with a meter that can monitor the amount of energy used by the household from the solar system. This meter facilitates billing and payback. The economic viability of the solar system is determined using payback analysis and life cycle cost analysis.

**Keywords**—life cycle cost, payback, solar photo-voltaic, solar water heating

## I. INTRODUCTION

THE cost of electricity in Kenya is relatively higher than in the rest of the East African region, not to mention a number of African countries such as Egypt and South Africa. It also has a relatively low installed capacity of about 1,900MW [1]. A large part of the population that is connected to the national grid also suffers frequent power outages due to supply shortfalls.

A large-scale market-driven penetration of small PV systems with capacity of 12 – 50 watts power (Wp) consisting of low cost amorphous silicon modules and both mono- and polycrystalline silicon modules, has been established in Kenya. It is projected that by 2020, the installed capacity of solar photovoltaic systems will reach 10MW generating 22 GWh annually.

The demand for solar water heating (SWH) is projected to grow to more than 800,000 SWH units by 2020. This represents a growth rate of 20% per annum. This demand will mainly be from domestic, institutional and small commercial consumers spurred by the operationalization of the Energy (Solar Water Heating) Regulations, 2012 [2].

Solar electricity use is dominated by a rural middle class made up of small business owners, rural professionals that

may not have access to electricity from the grid. Solar PV systems are widely used for household applications such as lighting, television, radio and cellular phone charging. However the significant role solar energy can play in urban and middle income households is yet to be realized.

This paper represents a design of a residential solar system comprising of a Photo-voltaic (PV) system and solar thermal system for water heating. The target of this system is households in Kenya with an electricity consumption of about 200kWhs-400kWhs. This paper established a viable payback system from savings made from the solar system.

## II. THE PHOTOVOLTAIC SYSTEM

Photovoltaic (PV) systems are powered by solar energy using solar modules. Photovoltaic cells are packed into modules that produce a specific voltage and current when illuminated. The generated electricity is stored in batteries and used for the purpose of lighting and small ac loads in domestic household application. These systems are most widely used in non-electrified rural areas and as reliable emergency lighting system for important domestic, commercial and industrial applications. The system comprises of Solar PV Module (Solar Cells), charge controller, battery and lighting and small ac loads system. The schematic of the home photovoltaic system is shown in below. The solar module is installed in the open on roof/terrace - exposed to sunlight and the charge controller and battery are kept inside a protected place in the house [3]. The two basic types of PV applications for homes are the stand-alone and the grid- connected systems. Stand-alone PV systems are used in areas that are not easily accessible or have no access to mains electricity grids. A stand-alone system is independent of the electricity grid, with the energy produced normally being stored in batteries. In the grid-connected applications, the PV system is connected to the local electricity network [4].

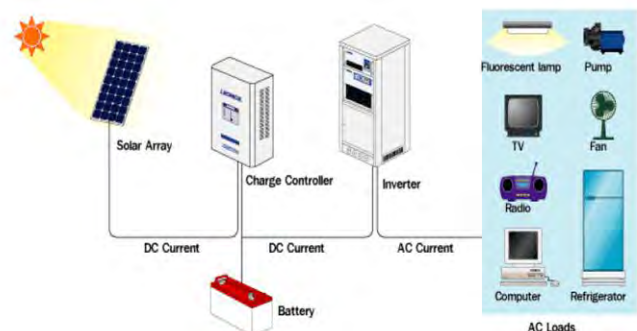

Fig. 1 Typical domestic solar PV system.

K. R, Department of Electrical and Electronic Engineering, JKUAT (phone: +254715010355; e-mail: [Kara.njeri@students.jkuat.ac.ke](mailto:Kara.njeri@students.jkuat.ac.ke)).

K. Y, Department of Electrical and Electronic Engineering, JKUAT (e-mail: [yegon.donald@students.jkuat.ac.ke](mailto:yegon.donald@students.jkuat.ac.ke)).

C. M, Department of Electrical and Electronic Engineering, JKUAT (e-mail: [cmuriithi@eng.jkuat.ac.ke](mailto:cmuriithi@eng.jkuat.ac.ke)).

### III. SOLAR WATER HEATING

Perhaps the most popular application of solar systems is for domestic water heating. The popularity of these systems is based on the fact that relatively simple systems are involved and solar water heating systems are generally viable. A solar water heater is a combination of a solar collector array, an energy transfer system, and a storage tank. The main part of a solar water heater is the solar collector array, which absorbs solar radiation and converts it to heat. This heat is then absorbed by a heat transfer fluid (water, non-freezing liquid, or air) that passes through the collector. This heat can then be stored or used directly. Thermosiphon systems, shown schematically in Fig. 2, heat potable water or transfer fluid and use natural convection to transport it from the collector to storage. The thermo siphoning effect occurs because the density of water drops with the increase of the temperature. Therefore, by the action of solar radiation absorbed, the water in the collector is heated and thus expands, becoming less dense, and rises through the collector into the top of the storage tank.

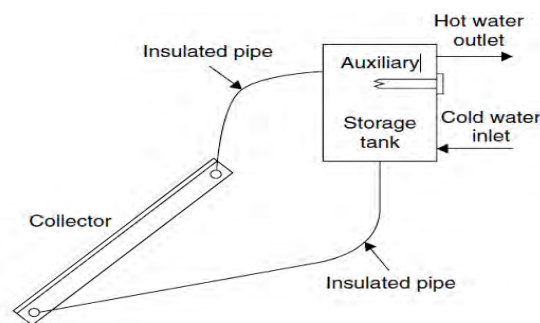

Fig. 2 A thermosiphon solar water heater.

### IV. SIZING OF PHOTO-VOLTAIC AND SOLAR WATER HEATING SYSTEM.

#### A. Energy Audit of sample households

Seven sample households that fall in the range of a monthly consumption of 200kWhs to 400kWhs, were selected from different locations within Nairobi. A site visit was done to the households. Power rating of major appliances and devices run in the household were determined. Through a questionnaire the inhabitants of the household gave information on the time period these power consuming devices are used daily. The total electricity used daily by the household in Kilowatt-hour (kWh) was calculated. The daily figure was then multiplied by 30 to get an average of the monthly electricity consumption of the household. The past electricity bills of the households were acquired to confirm their monthly electricity consumption. This information was recorded in a table for each household.

#### B. Estimation of the solar insolation available at the sites.

"Insolation" is the density of the energy that falls on a surface over some period of time such as an hour or a day (e.g. Wh / m<sup>2</sup> per hour/day). The solar insolation available at the site of the sample households was obtained from a report on:

Assessment of the solar radiation potential of the Thika and Nairobi area [5].

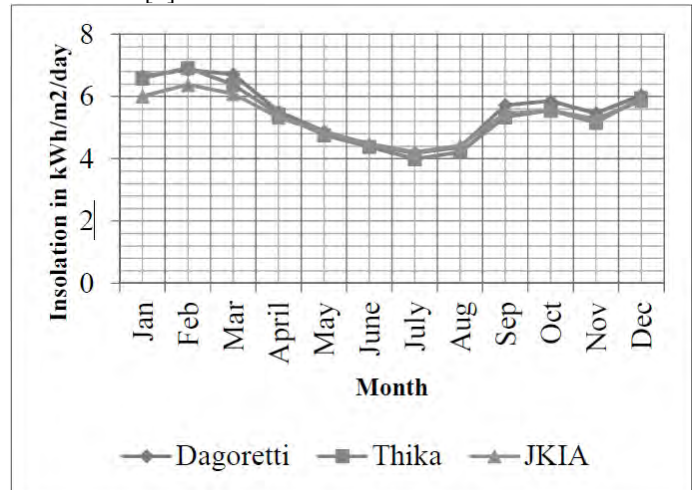

Fig. 3 Solar insolation graph.

#### C. Sizing of the PV system

##### 1) Calculation of Design Load and Energy Demand

- Design Load (Pd)

The design load is the instantaneous load for which the power conversion, distribution and protection devices should be rated, e.g. rectifiers, inverters, cables, fuses, circuit breakers, etc.

$$Pd = Pp(1 + Kg)(1 + Kc) \quad (1)$$

Where:

Pd is the design load real power (W)

Pp is the peak load real power, derived from the load profile (W)

Kg is a contingency for future load growth (%)

Kc is a design margin (%)

It is common to make considerations for future load growth (typically somewhere between 5 and 20%), to allow future loads to be supported. If no future loads are expected, then this contingency can be ignored. A design margin is used to account for any potential inaccuracies in estimating the loads, less-than-optimum operating conditions due to improper maintenance, etc. Typically, a design margin of 10% to 15% is recommended

- Design of energy demand (Ed)

The design energy demand is used for sizing energy storage devices. From the load profile, the total energy (in terms of Wh) can be computed by finding the area underneath the load profile curve (i.e. integrating instantaneous power with respect to time over the 24h period). The design energy demand (or design Wh) can then be calculated by the following equation:

$$Ed = Et(1 + Kg)(1 + Kc) \quad (2)$$

Where:

Ed is the design energy demand (Wh)

Et is the total load energy, which is the area under the load profile (Wh)

## 2) Calculation of solar insolation on an Inclined Plane

Most PV arrays are installed such that they face the equator at an incline to the horizontal (for maximum solar collection). The amount of solar insolation collected on inclined surfaces is different to the amount collected on a horizontal surface.

The solar insolation at the optimal tilt angle can be estimated. The optimal tilt angle largely depends on the latitude of the site. At greater latitudes, the optimal tilt angle is higher.

Optimal tilt angle was calculated by:

$$\beta_{opt} = 3.7 + 0.69|\Phi| \quad (3)$$

Where:

$\beta_{opt}$  is the optimal tilt angle (deg)

$\Phi$  is the latitude of the site (deg)

To calculate the solar insolation at the optimal tilt angle:

$$G(\beta_{opt}) = \frac{G(0)}{1 - 4.46 \times 10^{-4} \times \beta_{opt} - 1.19 \times 10^{-4} \times \beta_{opt}^2} \quad (4)$$

Where:

$G(\beta_{opt})$  is the solar insolation on a surface at the optimal tilt angle (Wh / m<sup>2</sup>)

$G(0)$  is the solar insolation on the horizontal plane (Wh / m<sup>2</sup>)

$\beta_{opt}$  is the optimal tilt angle (deg)

## 3) Sizing of battery bank

The “days of autonomy,” were determined. That is, the number of days the system is expected to provide power without receiving an input charge from the solar array.

$$Bc = \frac{Ed \times DoA}{Vdc \times DoD} \quad (5)$$

Where:

Bc is the minimum daily battery capacity (Ah)

Ed is the design daily energy (Wh)

DoA is the days of autonomy (in hours)

Vdc is the nominal dc system voltage (V)

DoD is maximum depth of discharge (%)

A battery Ah capacity that exceeds the minimum capacity calculated above was selected.

The number of batteries wired in parallel required was determined by: dividing the total battery capacity by the battery amp-hour rating of the selected battery and round off to the next highest number.

The number of batteries wired in series was determined by dividing the nominal dc system voltage (12V, 24V or 48V) by the battery voltage and round off to the next highest number.

To determine the total number of batteries required, the number of batteries in parallel was multiplied to the number of batteries in series.

## 4) Sizing of the PV array

The total amperage required from your solar array was determined by:

$$PV_A = \frac{Bc \times Be \times SF}{G} \quad (6)$$

Where:

Bc is the daily demand on battery capacity (Ah)

G is the solar radiation at the optimal tilt angle (Wh/m<sup>2</sup>)

Be is the battery charging efficiency (typically 80 – 90%)

SF is the soiling factor for installation (typically 0.9 – 1.0)

The maximum module temperature was estimated and the rating reference temperature (typically 25°C)

The required charging voltage from PV array was determined by:

$$PVv = Vdc - (Vdc \times \text{temperature coefficient} \times (\text{Max. Temperature} - \text{Reference Temperature})) \quad (7)$$

The charging power from PV array was determined by:

$$PVw = 1.2 \times PVv \times PVA \quad (8)$$

The factor 1.2 accounts for wiring losses, charge controller loss, PV module overrating and other losses

An appropriate PV modules for the system voltage is then selected.

The number of PV modules in series by was determined by dividing the module rated voltage from required charging voltage and rounding up.

The number of PV modules in parallel was determined by dividing the module rated current by required charging current and rounding up.

The total number of modules in array was determined by multiplying the number of modules in series with the number of modules in parallel.

$$\text{nominal power output of system (W)} = \text{nominal power rating of module (W)} \times \text{Total number of modules} \quad (9)$$

## 5) Sizing of Charge Controller and Inverter

The short circuit current of PV module selected was looked up.

The charge controller minimum power current = short circuit current of PV module x number of modules in parallel x 1.25

An appropriate charge controller was selected

$$\text{Inverter minimum power size} = Pd \times 1.25 \quad (10)$$

An appropriate inverter was selected

The factor 1.25 is the safety factor for continuous operation

## 6) A code was generated in matlab to carry out the sizing procedure

### D. Solar Water Heater sizing

According to **principle Hottel-Whillier** the useful energy output of a collector can be represented as:

$$Q_{coll} = A_c Fr (G - U_L(T_{f,i} - T_a)) \quad (11)$$

Where:

$Q_{coll}$ : is the Heat energy in the collector (Wh/day)  
 $A_c$ : is the Collector area ( $m^2$ )  
 $F_r$ : is the removal factor of solar collector  
 $G$ : is the solar radiation ( $Wh/m^2/day$ )  
 $U_L$ : is the Coefficient of thermal losses from solar collector  
( $W/m^2 \cdot ^\circ C$ )  
 $T_{fi}$ : is the Inlet water temperature for solar collector ( $^\circ C$ )  
 $T_a$ : is the air or ambient temperature ( $^\circ C$ )

$$Q_{load} = \dot{m}_L C_p (T_S - T_L) \quad (12)$$

Where:

$\dot{m}_L$ : is the mass flow rate (kg/sec)

$C_p$ : is the specific heat capacity of water,  $1.161 \times \frac{10^{-3} kWh}{kg \cdot ^\circ C}$

$T_S$ : is the average temperature of hot water in the storage tank ( $^\circ C$ )

$$Q_S = m_s C_p \left( \frac{T_S - T_a}{\Delta t} \right) \quad (13)$$

Where:

$Q_S$ : is the Energy per unit time in the storage tank (W)

$\Delta t$ : is the change in time in hours

It is assumed that  $Q_{loss}$  is 20% of energy in the storage tank,  $Q_S$

**Therefore:**

$$Q_S = Q_{coll} - Q_{loss} - Q_{load} \quad (14)$$

Based on the equations above a code was generated in matlab to size the system required for each household.

## V. DESIGN OF METER

### A. Hot water management and monitoring

A water flow sensor was used. It consists of a plastic valve body, a water rotor, and a hall-effect sensor. When water flows through the rotor, it rotates. Its speed changes with different rates of flow. The hall-effect sensor outputs the corresponding pulse Signal. The sensor produces a series of pulses that are counted by the microcontroller according to the calibration. Since it gives the speed of the flow, the volume is then calculated from it by taking the speed in liters per second and adding up the volume every second.



Fig. 4 Water flow sensor.

For both the purposes of determination of energy saved in heating the water as well as user feedback for decision making, a temperature sensor, DS18B20 was used. This sensor outputs analogue values of temperature to the serial port of the microcontroller. These values are then output to the LCD display as well as used to calculate water savings



Fig. 5 Temperature sensor DS18B20.

To allow the user to know the amount of water in the hot water tank an ultrasonic sensor is employed. This sensor is able to determine the depth of water in a tank whose dimensions is known. Based on this the amount of water was calculated and outputted through an LCD display.



Fig. 6 Ultrasonic sensor.

### B. Electrical energy management and monitoring.

In this system the voltage and current levels are measured at intervals of a second. The implementation of voltage measurement is through voltage divider to allow a maximum 3V from the system battery 12V to reach the microcontroller. A hall effect current sensor is used to measure the current being drawn by the load. The power is then computed by multiplying the two to get the wattage. This value is used to compute the kilowatt hours over the time it was measured.



Fig. 7 Current sensor.

Relay switches are used to connect the given household to and from the system.

## VI. DETERMINATION OF OPTIMUM SIZE OF SYSTEM

### A. Photovoltaic system.

For each sample household, PV systems were sized to meet 5%, 10%, 15%, 25%, 50% and 100% of the estimated energy load.

The cost of each system was estimated using data sheets and price lists obtained from Power Technics, a major solar equipment distributor in Kenya. Through analysis of the sizing of various components in the PV system and their cost, it was evident that the inverter and charge controller cost varied greatly due to difference in peak power. With cost as a major factor, it was determined that a 12V photovoltaic system, with a peak power demand of 400W and energy demand of 1000Wh costing approximately 100,000ksh could be used.

### B. Solar water heating system

From the sampled households, it was determined that the average number of people in a household was five. The number of people in a household determines the daily hot water requirements for that household. The hot water requirements are used to determine the most suitable size of collector. The collector size calculated was **2.004m<sup>2</sup>**.

Based on the price list given by Solimpex, a solar water heater (SWH) distributor in Kenya, a T200 SWH with an output capacity of **250liters/day** and a collector area of **2.5m<sup>2</sup>** costs **150,000Ksh**.

## VII. PAYBACK PERIOD ANALYSIS

### A. Payback period for photovoltaic system alone

Monthly Saving

= Energy demand per month (KWh)

× cost of electricity per month per kWh (ksh)

Capitalcost = (Totalcostofsystem)

$$\text{Paybackperiod(in months)} = \frac{\text{CapitalCost}}{\text{Monthlysavings}} \quad (13)$$

For the selected system:

$$\begin{aligned} \text{Paybackperiod(in months)} &= \frac{100,000}{1,000 \times 30 \times 22} \\ &= 151.52\text{months} \\ &= 12.63\text{years} \end{aligned}$$

### B. Payback period for solar water heating system alone

- From the sample households, the average daily hot water load =5.174kwh

In a month assuming a 30 day month, average hot water load= 155.22 kWh

**Payback for a load of 155kwh is:**

$$\begin{aligned} \text{Paybackperiod(inmonths)} &= \frac{150,000}{155 \times 22} \\ &= 43.98\text{months} \\ &= 3.67\text{years} \end{aligned}$$

- For a household with an energy load of 400Kwh per month, and hot water load is 50%

**Payback for a load of 200kwh is:**

$$\begin{aligned} \text{Paybackperiod(inmonths)} &= \frac{150,000}{200 \times 22} \\ &= 34.09\text{months} \\ &= 2.84\text{years} \end{aligned}$$

- For a household with an energy load of 200Kwh per month, and hot water load is 50%

**Payback for a load of 100kwh is:**

$$\begin{aligned} \text{Paybackperiod(inmonths)} &= \frac{150,000}{100 \times 22} \\ &= 68.18\text{months} \\ &= 5.68\text{years} \end{aligned}$$

### C. Payback period for PV system and SWH system

From the large payback period of the photo-voltaic system and the relatively smaller payback period of the solar water heating system, it has been noted that it is necessary to combine the two systems so together they can have a viable payback period.

Photovoltaic energy load per month: 30kWh

Photovoltaic system total cost: 100000

TABLE I  
PAYBACK PERIOD FOR COMBINED SYSTEM

Hot water energy load per month(kWh)	Total energy load (kWh)	Capital cost of both systems	Payback in months	Payback in years
100	130	250000	87.41	6.78
150	180	250000	63.13	5.26
200	230	250000	49.4	4.12

## VIII. LIFE CYCLE COST (LCC) ANALYSIS

The LCC of an item consists of the total costs of owning and operating an item over its lifetime, expressed in today's money.

The LCC of the system includes the sum of all the present worth (PWs) of the individual components. In this case the LCC of the combined PV and solar water heating system includes the PWs of the PV modules, storage batteries, inverter and charge controller and the solar water heating system.

The lifetime N of all the items is considered to be 20 years, except that of the battery which is considered to be 5 years. Thus, an extra 3 groups of batteries have to be purchased, after 5 years, 10 years, and 15years.

The current inflation rate in Kenya is **6.43%** and the average discount or interest rate **d** is **8.5%**.

$$PW = Cost \left( \frac{1+i}{1+d} \right)^N \quad (14)$$

Where, N=number of years

Table II shows the calculated LCC of the system.

TABLE II  
LCC FOR SYSTEM FOR A MONTHLY LOAD OF A MONTHLY LOAD OF **130KWH, 180KWH AND 230KWH**

Monthly load (kWh)	ALCC (ksh) (N=5)	Ksh/kWh (N=5)	ALCC (ksh) (N=7)	Ksh/kWh (N=7)	ALCC (ksh) (N=8)	Ksh/kWh (N=8)	ALCC (ksh) (N=20)	Ksh/kWh (N=20)
130	68447.34	43.8765	49823	31.9378	44007.15	28.21	19657.33	12.6
180	68447.34	31.6886	49823	23.0662	44007.15	<b>20.37</b>	19657.33	9.1
230	68447.34	24.7998	49823	<b>18.0518</b>	44007.15	<b>15.944</b>	19657.33	7.12

TABLE III  
THE ALLC AND UNIT ELECTRICAL COST

Component	Cost	Purchased after N=years	PW
PV array	48000	0	48000
Battery set 1	32000	0	32000
Battery set 2	32000	5	29061.74
Battery set 3	32000	10	26393.27
Battery set 4	32000	15	23969.82
Inverter and charge controller	20000	0	20000
SWH system	15000	0	150000
TOTAL LCC			329424.83

a unit electrical cost of **18.0518Ksh/kWh**. For a payback period of eight years, solar systems that meets 180 kWh monthly and 230kWh monthly of the energy demand of the household have a unit electrical cost of **20.37Ksh/kWh** and **15.944Ksh/kWh** respectively.

#### REFERENCES

- [1] EED Advisory, "Energy Access Review, Energy, Environment and Development Advisory" Nairobi, 2014, 14-Q2EA.
- [2] Ministry of Energy, The National Energy Policy, February 24, 2014.
- [3] Dr. P. Jayakumar, "Solar Energy Resource Assessment Handbook," 2009.
- [4] Malestorm, Solar Energy Engineering- Processes and Systems. London: Academic Press, 2009.
- [5] T.N. Soitah, S. M. Waweru, F.N. Kariuki N.W. Wasike, "Assessment of the Solar Radiation Potential of the Thika and Nairobi Area," Jomo Kenyatta University of Agriculture and Technology, Nairobi, Vol. 16, 2014.

It is useful to calculate the LCC of a system on an annual basis. The annualized LCC (ALCC) of the PV system in terms of the present day ksh can be calculated as:

$$ALCC = LCC \frac{[1 - \frac{1+i}{1+d}]}{1 - \frac{1+i}{1+d}^N} \quad (15)$$

ALCC can be used to determine unit electrical cost.

$$unit\ electrical\ cost = \frac{ALCC}{12 \times EL\ per\ month} \quad (16)$$

Where N= lifespan of the project or payback period

#### IX. CONCLUSION

From the life cycle cost analysis, one can conclude that a viable system is one with a unit electrical cost less than the current unit electrical cost of 22ksh/kWh. From the payback analysis done it is evident that a combined system is more viable. The **unit electrical cost** calculated in the life cycle cost analysis can be used to price the energy supplied to a household from the photo-voltaic system and solar water heating system. 1kWh should be the same price in both systems so the solar water heating system can contribute towards the payback for the photovoltaic system. For a payback period of seven years, a solar system that meets 230kWh monthly of the energy demand of the household, has

# Review of Thermal Surface Drilling Technologies

R. Ndeda, S. E. M. Sebusang, R. Marumo and E. O. Ogur

*Abstract*—Mechanical methods of drilling have been widely applied in drilling for water, petroleum, natural gas and geothermal energy. However, limitations such as rapid tool wear as well as downtime necessary for tool bit replacement and maintenance have facilitated the entry of non-contact drilling methods. Further, increased supply through discovery of new reserves, has been an added impetus towards the development of cheaper and more effective drilling alternatives.

Thermal drilling is a non-contact drilling method that was developed in the late 20th century. It involves the application of thermal energy to penetrate rock formations. This paper presents, through a review of literature, the state of the art of thermal drilling methods, analyzing previous and present approaches. Future research areas for each of the methods are also highlighted.

*Keywords*—Thermal spallation, Super Deep Fusion, Laser Drilling, Hydrothermal Spallation, Flame Jet Drilling, Electropulse Boring

## I. INTRODUCTION

**R**OTARY drilling has been the most popular drilling method for petroleum and gas since 1900, when its implementation replaced cable drilling [1]. The method utilizes a rotary drill bit which is forced onto the rock, consequently crushing it. The method has been used for drilling for water, oil, gas and geothermal wells. Whereas the efficiency of the method has somewhat improved since its first introduction into the market, certain challenges have drawn research into other means of drilling.

Geological conditions of the location of the well has a large impact on the drilling cost. For example, research indicates that well costs in Germany are the highest worldwide, due to the geological conditions [2]. A study of the relationship between well costs and well depths indicated an exponential relationship, which is attributed to the hard crystalline rocks, prevalent in deep well drilling [3]. In an alternate scenario, where different rock types are arranged in layers, the drilling process would encounter several stops, which would involve changing of the drill bit to suit the specific rock [4]. This leads to reduction in overall drilling speed and hence increasing the cost.

Wear of the drill bit also contributes to inefficiency in the drilling process. Apart from machining hard rocks, high temperatures involved in deep underground drilling also affect the drill bit [5]. Maintenance of the drill bit and accessories involves taking the tool up to the surface and returning it to its original position, a process called 'tripping'. An increase in

tripping time leads to corresponding increase in drilling cost. Research posits that increase in bit life would reduce the total well cost by 5% [6].

Another common challenge encountered when using a drill string is the deviation from the vertical. Rotation of the drill string increases the frictional forces experienced which leads to a non-vertical hole. This may lead to differential stresses, leading to the instability of the hole [7]. In addition, other conditions which may further affect the drilling process are overpressure of the well, underbalanced well and swelling of the rock [8], stuck pipe and fishing for lost tools in the downhole environment [9].

Technical advances in the drilling tool and accessories have caused a slight reduction in the cost of well drilling. The advent of the tricone bit reduced the number of drilling runs, despite experiencing similar steering limitations as roller cone and drag bits [10]. Research and development focused on new methods of drilling seeks to reveal more efficient drilling methods, that will curb costs while increasing the rate of penetration into the rock.

Thermal drilling methods mainly employ the use of thermal energy to exert stress on the rock. Removal of the rock can be achieved either through melting and vaporization or through spallation. These methods have the advantage of lack of contact between the tool and the rock surface. Since the tool is not subject to wear like a conventional drill bit, using these methods is expected to reduce tripping time for maintenance and repair of drill bits, hence overall reduction in drilling time [11].

This paper provides an exploratory analysis of the most popular thermal methods, indicating the advantages and limitations, as well as providing a peak into the future.

## II. ROCK MELTING

Application of thermal energy to the rock leads to melting of the rock. Further heating leads to vaporization. This section discusses drilling methods which use melting as a mode of rock removal.

### A. Super Deep Fusion Drilling

Deep geothermal drilling is the current market leader for drilling tools due to the world push towards clean energy sources. Hydrothermal geothermal systems, where steam at high pressure is obtained from rock formations that have adequate permeability and water, were widely used in the 20<sup>th</sup> century. However, the development of Enhanced Geothermal Systems (EGS) have enabled extraction of geothermal energy in rock formations that are devoid of water and permeability. This method relies on the circulation of water through fractures created during the drilling process in order to

R. Ndeda, Department of Mechanical Engineering, University of Botswana (phone: +2673554365; e-mail: reheman@eng.jkuat.ac.ke).

E. Sebusang, Department of Mechanical Engineering, University of Botswana (e-mail: Sebusang.Sebusang@mopipi.ub.bw).

R. Marumo, Department of Mechanical Engineering, University of Botswana (e-mail: marumorr@mopipi.ub.bw).

E. O. Ogur, Department of Mechanical & Mechatronic Engineering, Technical University of Kenya (e-mail: ericokoth@hotmail.com).



generate sufficient steam for energy generation [12]. Whereas conventional holes for oil and gas reach a depth of 2kms, EGS requires wells of upto 5kms. At these depths, certain limiting conditions for conventional rotary drilling exist. The change in rock behavior from brittle to ductile makes it harder for conventional methods to drill. In addition, the stability of the well, which is enhanced by the presence of drilling mud, is compromised at high temperatures and pressures (greater than 373.95° C and 220.64 bar respectively [13]) due to the reduction in the density of water, leading to a high likelihood of well collapse [14]. Another limitation of the conventional drilling process is the possibility of lost circulation when using drilling fluids, hence leading to leakage into the well which prevents well completion [15].

Super Deep Fusion Drilling uses a superheated molten metal to heat the rock face. Continuous heating through alternative magnetic fields in the drilling head causes the hole to deepen. The molten material solidifies into a casing for the well after being pressed by a compactor. After-cooling is then accomplished by the use of a heavy fluid which increases compressive forces on the casing as well as stabilization of the well [16]. This method is estimated to be able to drill 20km pit with diameter of 1m at a cost of €3300/m. This cost is inclusive of steel casing [17].

This method has the advantage of automatic casing as the drilling continues. In the case of oil and gas drilling, continuous casing of the rock ensures a closed environment, where there are no expected blow outs [18]. A further advantage is that it is unnecessary to have a means of disposal or transport of the rock cuttings to the surface. Once drilling of the well has been completed, the recyclable parts of the drilling head ensure that there is no need for waste disposal mechanism.

This method is, however, limited where karst regions which are characterized by holes, caves, and underground drainage systems exist. These areas would require the addition of conventional drilling as well due to the unexpected water outbursts [19].

Apart from EGS, this method is widely applicable for super deep well applications such as mining of minerals which dissolve at high pressures and recycling and extraction from oil and gas wells. The method is currently at the patent stage for most of the test equipment. However, further research should be engaged in analyzing dry rock characteristics and the applicability of this method on the same.

### *B. Microwave Drilling*

Microwave energy has been widely applied in the industrial and scientific sectors. Application in rock drilling only came to the fore 50 years ago. The major challenge in development of the microwave drill for many applications has been the thermal runaway phenomenon, which indicates uneven heat dissipation and temperature distribution in material [20]. This has been attributed to resonance of electromagnetic waves within the object, in addition to heat loss characteristics of the material [21]. These losses would make the process extremely inefficient.

Research conducted by Jerby and Diktar [22] developed a means of concentrating the microwave energy to a small

spot in order to generate enough heat for rock removal. This was based on earlier research which indicated the dependence of microwave drilling on the power density delivered and the method of delivery to the rock [23]. Further, Whittles et al. [24] indicated that greater stresses were generated by increasing the power density instead of increasing the energy supply. The viability of microwave drilling for rock removal has been improved by these discoveries.

Microwave heating can be used for melting of the rock strata as well as spallation. In the case of melting, the method involves deposition of microwave energy to the intended spot around the microwave radiator. The underlying surface is at a higher temperature than the surface due to cooling effects of the machining environment. With continuous application of the microwave energy, the subsurface regions begin to melt. An electrode is then used to push the molten material to the boundaries of the hole. It is observed that the microwave drill is capable of making holes of  $10^{-3}$  -  $10^{-2}$ m [25]. Where spallation is the intention, differential absorption of the microwave energy by a heterogeneous rock sample leads to fracture of the rock [26]. Since absorption of microwave radiation by the rock is dependent on the dielectric properties of the individual constituents of the rock, differential expansion of these individual grains would lead to varied tensile and shear stresses [27]. Microwave spallation has been deemed to occur in quasi-homogeneous rocks such as basalt, gabbro and granite [28].

Laboratory experiments have been performed in microwave ovens [29] and through single mode application [30]. Research on the fracture and drilling of various rock types indicates that certain minerals easily absorb microwave energy (magnetite, chalcopyrite and water), hence, promoting the use of microwave energy in these environments. Those that do not absorb microwave energy include feldspar, quartz, marble and ice [31]. The presence of water in the pores of the rock has been noted to slightly aid the drilling process. Comparison between the operation of microwave energy between water saturated and dried samples indicated a considerable increase in heating rates for water-saturated granite and sandstone, with no change in basalt [32]. This research informed the fact that microwave drilling is dependent on both the type and the heterogeneity of rock. Consideration into the behavior of rocks with relation to period of exposure to microwave power indicates significant strength reduction in rocks with short exposure times. Further, there is a power limit above which there is no breakage induced in the rock [30].

The advantage of the microwave drilling process is that while rotation of the electrode is a requirement, the slow rotation involved does not cause mechanical friction, hence the possibility of directional holes is observed. Further, due to the use of the molten material, there is low wastage as well as a dust free environment [26]. Application of microwave spallation are in the treatment of minerals, where heating is directed and controlled for specific phases [33] and mining in space [34].

Limitations of this method are that the initial capital investment is very high, further aggravated by the dependence of operational costs on the life span of the magnetron. Further,

the inefficiency involved in conversion of electric energy to microwave energy (65%-90%) may be discouraging [35]. It is also mandatory to have adequate shielding to prevent microwave leakage.

### III. THERMAL SPALLATION

The mechanism of thermal spallation has been present since the early 1900s [36, 37]. Thermal spallation involves the application of thermal stress to fracture the rock surface. The method is mainly dependent on flaws (micro-cracks) inherent in the rock formation. On application of heat, thermal stresses are generated due to the steep temperature gradient between the rock surface and the underlying layers, causing the extension of microcracks. When the thermal stresses exceed the compressive stress of the rock, a chip violently buckles off the surface [38]. Thermal energy can be supplied using a flame, super-heated water jet, microwave or laser beam. Thermal spallation has found wide application in drilling of boreholes, opening small orifices for installation of explosive charges and other mining applications.

To be considered, however, is the fact that spallation drilling hinges on the capability of rocks to spall. Experiments by Williams and Potter [39] indicated that certain soft and ductile rocks (limestone, soft sandstone, shale) did not spall under application of continuous heat. However, Xu et al [40] determined that spallation of soft and ductile rocks occurred on alternate heating and cooling of the rock.

Spallation is largely dependent on the energy applied to the rock. The spalling zone of rock occurs just below the melting temperature of the rock. Initial application of heat creates thermal stresses in the material due to the low diffusion rate into the rock. Continued application of heat would raise the temperature of the rock to melting point without spalling [41]. The delicate balance between supply of heat flux and surface temperature of the rock should be maintained within the brittle-plastic transition region.

Another aspect of thermal spallation that should be considered is the limitation of the area of application of the heat flux. Studies by Rauenzahn [42] indicated that application of heat flux should be limited to 10% of the rock surface, to ensure that the induced thermal stresses are not relieved, preventing spallation.

It is estimated that thermal spallation drilling could result in shorter downtimes and overall increase in drilling speed. Figure 1 shows expected linearization of cost versus depth index due to thermal spallation, also known as "linear drilling", as suggested by Potter and Tester [43].

The most popular methods of thermal spallation drilling are flame jet drilling, laser drilling, hydrothermal spallation and electropulse boring.

#### A. Flame Jet Drilling

The most popular method of thermal spallation is flame jet drilling, which owes its popularity to the high penetration rates that are achievable in hard rock types [11,44]. Flame jet drilling utilizes gas flow from the burner for removal of spalls from the drill site.

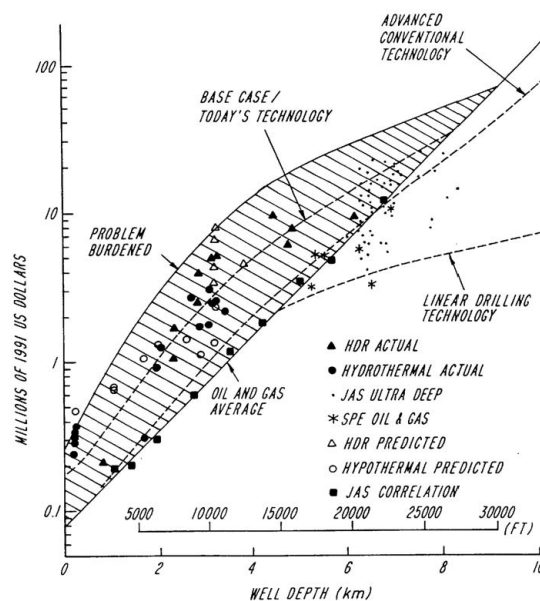

Fig. 1. Cost versus depth comparison for various drilling technologies.

Initial commercial tests of flame jet technology were performed in 1940 in mining of taconite [45]. With the closure of the taconite industry, the technology lay dormant till the mid-70s where the method was applied to drilling of geothermal wells. Browning Engineering Company, in the mid-70s, indicated an average penetration rate of 52ft/hr when drilling granite using flame jet technology [46]. Comparison between flame jet drilling and conventional methods which achieve an average penetration rate of 16.2ft/hr, indicates a massive improvement. Another advantage of the method is its capability to drill very narrow holes as well as holes of upto 20 times the diameter of the flame jet nozzle [47]. This means that it can be used for both well drilling and completion.

Within the past 20 years, applications of flame jet drilling have, however, been limited to drilling of shallow holes (less than 0.5km) at ambient pressures [42, 48]. This is due to several reasons. First, an air-filled environment is required for the purpose of maintenance of the flame as well as spall removal from the drill site. Due to the high pressures in deep drilling, the air-filled hole is largely unstable, aggravated by the water intrusion which may hamper the gas-enabled spall removal [49]. A further limitation in drilling large hole diameters is the reduction in lift velocity of the exhaust gas. Efficiency of spall removal is, therefore, impeded [50]. Second, deep drilling requires a high density drilling fluid, commonly known as drilling mud, which apart from carrying away particles, serves to balance the pressure in the well. This would mean ignition and maintenance of the flame in a liquid-filled environment.

Current research efforts are concentrated in studying the feasibility of using flame jet spallation for deep geothermal wells. Augustine et al [51] developed a flame capable of operating in a high pressure and density environment. The hydrothermal flame uses the principle of hydrothermal combustion where the oxidation process takes place at supercritical

conditions while in a dense aqueous environment [52]. Results demonstrated a generated heat flux of  $0.5\text{MW/m}^2$  compared to that of  $1\text{MW/m}^2$  for spallation in a low density environment at ambient pressure. Despite this variation, the generated heat flux was still within the range capable of inducing spallation. An added advantage of the hydrothermal flame is the potential for use at supercritical conditions. Rothenfluh [53] estimated that the hydrostatic pressure of the well exceeds the critical pressure of water at a depth of 2200m, which is the suitable condition for ignition and combustion of the hydrothermal flame.

Despite this progress, this method is limited significantly through the entrainment of the generated hydrothermal flame. Experiments conducted by Tester and Augustine [54] indicated that the supercritical jets were quenched by turbulent flow around the flame. This phenomenon is known as entrainment, which refers to the tendency of fluids to be drawn towards turbulent jets. Density and momentum differences between the flame and surrounding fluid initiates turbulent mixing, which then results in reduction of the temperature from supercritical to subcritical levels [11, 55]. This entrainment was found to grossly affect temperatures of the flame, such that spallation could not occur. Current research is concentrated on understanding and consequently elimination of these entrainment effects for efficient spallation in the deep drilling environment.

A further limitation of flame jet spallation is the safety threat posed by the possibility of combustion in oil and gas wells [56]. This situation, however, is not likely to be experienced in geothermal drilling, hence is a suitable application of this method. Application of flame jet spallation in extraction of close-to-the-surface minerals has been successful, where the spalls generated are processed for precious minerals.

It is evident that with growth of technology, many applications and yet more challenges are encountered. Whereas flame jet spallation is prospectively capable of replacing rotary drilling, current research efforts should in effect be concentrated on the reduction or eventual elimination of inefficiencies of the process.

### *B. Hydrothermal Spallation Drilling*

Hydrothermal spallation drilling is the means of drilling which utilizes a high-temperature fluid jet to provide heat for the process. This method was designed as one of the solutions to the challenge of use of the flame jet in the downhole environment. The method utilizes hydrothermal flames enclosed within a combustion chamber in order to heat a stream of water, which is then ejected from the nozzle at high temperatures capable of causing spallation [57].

A comparison between mechanical drilling and hydrothermal spallation drilling of granite indicates a rate of penetration of 15ft/hr and 40ft/hr respectively [58]. Further, the process has been found to be effective at supercritical pressures prevalent in deep drilling. This, therefore, means an overall reduction in costs in deep drilling where there are hard, crystalline rocks. This method also has the advantage of improved trajectory control due to the lack of contact with the rock surface [49].

The largest hindrance to the efficiency of the hydrothermal spallation drilling method is entrainment of drilling fluid into the hot water jet region. This causes loss of heat in the jet before the energy can be transferred onto the rock. Investigations conducted by Rothenfluh [53] indicated that changing the operating conditions had no effect on reduction of entrainment. Current research in hydrothermal drilling is targeted at reduction of entrainment by drilling fluid. It is also necessary for future research to establish the effect of flow reversal of the jet fluid after impinging the rock [11].

Hydrothermal spallation has been targeted for application in EGS. Due to the breadth of laboratory-based research, it will be imperative to conduct downhole testing of the method, along with the tool head design, in the future. It would be important to understand the behavior of the rock under applied stresses in a high pressure and temperature environment. Sensor development for the harsh downhole conditions is also a viable field of study. Sensors would be required for suitable heat detection of entrainment effects during spallation. This would assist in computation of spallation conditions at the drilling head and nozzle as the process progresses. Application areas related to EGS such as drilling of slim holes and directional drilling will also require investigation [49].

### *C. Laser Drilling*

The use of laser technology in well drilling has previously been used for analysis. This includes oil film thickness measurement [59], detection of the crude oil properties [60] and permeability damage [61]. Investigations into the use of lasers for drilling were conducted in the late 60s and 70s. However, the inefficiency of the lasers caused the method to be rejected. Later, the development of high power lasers [62] and the use of fiber laser beam delivery technology [63] ensured the delivery of the beam to the downhole environment in addition to its ability to drill rock.

An outstanding advantage of the process is the obvious lack of contact between the tool and the rock face, which reduces tripping time due to the reduced wear. This foreseen cost reduction has been a driving force towards its adoption in the industry. A gas well of 3048m depth would cost \$35,000 when using the laser as compared to mechanical methods which would attract investment of \$350,000 [64]. Further, due to its faster rate of penetration into the rock, it is estimated that laser drilled wells will take 90% less time than conventional methods [65]. Faster drilling time means reduction in damage to the ecosystem. It is, also, envisaged that the environmental impact of the laser drilling would be lower than conventional means. In relation to power required, a 20kW fiber laser is powered by 1.5kW compared to a mechanical drill rig which requires 1.5MW of power to generate 2000HP [66].

The mechanism of rock destruction using lasers is through thermal spalling, melting and vaporization. Application of heat to the surface of the rock causes an instant increase in temperature which causes spallation. However, continued application of the localized heat flux results in dissipation of energy through various mechanisms. Melting of the rock occurs due to the absorbed flux. Other minerals such as clay

present in the pores of the rock are dehydrated, forming a glassy phase which also reflects the laser. Finally, this dehydration of the minerals cause formation of plume which decreases the energy transferred to the rock. This dissipated energy causes inefficiency in the laser, preventing it from reaching the exposed under-rock [67].

The lowest values of specific energy are attained during thermal spallation while the highest values occur when melting and vaporization of the specimen occurs. Spallation is, therefore, a juggling act to ensure that the energy input does not raise the temperature of the rock to melting. The use of pulsed lasers has been effective in this concern [68]. Research indicates an increase in rock removal when a pulsed laser with a high repetition rate is used in spallation. This has been attributed to the laser-driven shock wave that is generated by the increase in thermal cycling frequency [67]. Kobayashi et al [69] observed that spallation of adjacent rock surfaces occurred without laser irradiation being applied on the whole surface. Spallation, therefore, does not limit the size of the hole to the spot size of the laser. Optimization of the relaxation time is necessary in order to achieve optimum values of specific energy.

Spalls are removed from the borehole using purge gas. Nitrogen is the most common gas used for this application with co-axial purging found to enhance drilling [70]. However, the use of the laser with a mechanical scraper has been used in certain situations for spall removal [71].

Spallation in water filled environment has been investigated. It was determined that the rock melted instead of spalling. This occurred at certain laser wavelengths, depending on the water absorption coefficient. Further, the lower wavelength lasers were capable of functioning with a jet of water supplied in the drilling area. Despite these positive results, laser energy was dissipated through the following: absorption and reflection of the laser by water blockage by steam and clouded water and spattering of water [72]. This leads to diminished rate of penetration. In the case of water-saturated samples, it was noted that the specific energy required for water-saturated samples was high due to the high vaporization point of water and lower absorption rate of laser energy by water [73].

Another widely accepted application of lasers is perforation and completion of wellbores. Investigation into the laser perforation was done at high pressure by Gahan et al [74]. It was determined that the confining stress improved the thermal diffusivity of the rock due to the close contact of the grains. This led to an overall improvement of the perforation process.

Apart from the limitations already mentioned, other challenges require addressing before the method can be taken to market. Future research should be focused on equipment design for efficient performance for deep drilling and well perforation. Delivery of the laser to the downhole environment should be at the fore. The conventional drill string can be adapted for delivery of the laser. Since the laser has no Weight on Bit (WoB), studies suggest the use of a composite metal matrix instead of steel as there is no need for high tensile and compressive strength of the drill string [67].

It is also imperative to understand the mechanism of laser energy dissipation as well as drilling parameters which require

control. Modeling of these processes will go a long way to explaining laser rock interactions. Additional investigation into the role of these parameters on both spallation and melting of rock in the drilling environment will be crucial. It is also important to analyze the laser-rock interaction when exposed to elevated supercritical pressures prevalent in downhole drilling.

#### D. Electropulse Boring(EPB)

Initial research into Electropulse Boring began in the 70s, with the notion of pulsing electrical voltage for generation of a shock wave [75]. In 2009, Bergen-Norway commissioned research into electropulse boring for drilling of geothermal wells [76]. The method employs transmission of electric pulses of between 100-1000kV through fluid-submerged electrodes in contact with the rock surface. On passing of the pulse through the rock, a volume of rock breaks away from the surface. Subsequent application of pulse causes further cracking of underlying rocks.

It is foreseen that this method should be able to drill large diameter, super-deep holes in hard formation with low costs. Rate of penetration of upto 35m/hr for a 50cm diameter borehole was achieved while drilling granite, which is comparable to the aforementioned methods. The extrapolated cost of drilling a 9km deep hole would be 1€M compared to the current rotary drilling costs of 100€M as shown in Figure 2 [76].

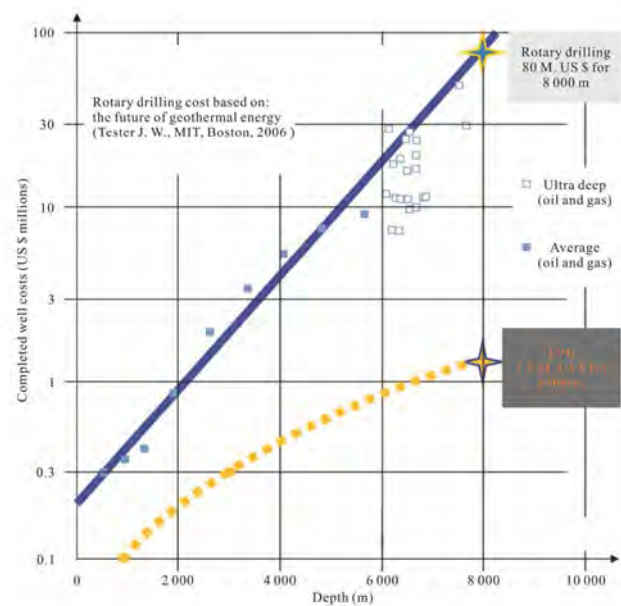

Fig. 2. Cost comparison between Rotary Drilling and Electropulse Boring [76]

This method can be applied in drilling large diameter wells, which are larger than the size of the EPB bit. The suggested method of delivery of the tool bit downhole has been through the use of the conventional drill string, with replacement of the drill bit with a boring tool. This method has, however, been constrained by the fact that the tripping time to replace the bit would subtract from the high rate of penetration benefits.

Whereas there is significant saving in the high rate of rock breakage, there is significant energy consumed in the use of annular fluid flow for transportation of cuttings when the diameter of the borehole is large. However, this can be significantly reduced by using a hose for this purpose [77].

Due to the vast differences in EPB technology and that currently in use for rotary drilling, adoption of this technology would require changing of all the equipment. Other risks associated with this method such as handling of high voltage on a continual basis would also require adherence to strict procedures during the drilling operation.

Focused research is therefore, required for development of a suitable drill rig, with suitable delivery of the tool to the downhole environment. In addition, it should be of paramount importance to analyze the operation of EPB in the downhole environment with increased temperature and supercritical pressure regime. Further, the effect on the drill rig would also be necessary to determine.

#### IV. COMPARATIVE ANALYSIS

Three parameters are commonly used for the determination of the efficiency of drilling methods. These are power used in the process, rate of penetration and specific energy. When mechanical drilling methods are used, the power input is expended in application of force which is greater than the strength of the rock, hence causing disintegration. Similarly, the use of thermal methods require enough energy to exceed the compression strength of the rock to cause fracture (spallation) or exceed the melting temperature of the rock [65].

Specific energy is a common unit in determining the efficiency of drilling method. Specific energy of thermal drilling processes is defined as energy required to disintegrate one cubic volume of rock and is defined by equation 1

$$\text{Specific Energy} = \frac{\text{Energy Input}}{\text{Volume of rock removed}} \quad (1)$$

For mechanical methods, specific energy can generally be defined as:

$$S_e = \frac{\text{Mechanical Power Applied to the Rock}}{\text{Volumetric Rate of removal of the rock}} \quad (2)$$

For rotary drilling, equation 3 is used to determine the specific energy.

$$\text{Specific Energy} = \frac{\text{WoB}}{A_{Bit}} + \frac{120\pi \times T \times \text{RPM}}{A_{Bit} \times \text{RoP}} \quad (3)$$

where T is the torque generated, ABit is the Bit Area, WoB is the Weight on Bit and RoP is the Rate of Penetration.

Specific energy is dependent on several underlying factors. Different types of rock have a wide variation of properties and hence react differently to exposure to thermal energy. Rock formations with higher conductivity enable faster diffusion of heat into the rock, hence, lower specific energy is required. Further, heterogeneous rocks would behave differently, depending on the mineral composition and packing of the grains. For example, rocks containing a large percentage of quartz have a higher melting point [64]. Mineralogy of the rock could encourage formation of macro fractures which lead to energy loss and dissipation. Time of exposure of the rock to

the thermal energy also affects the specific energy [65]. Table I makes a comparison of the specific energy used in drilling for the different thermal drilling methods. The table also indicates the rock formations in which drilling was performed. To achieve an adequate comparison, it would be pertinent for drilling to be performed on a similar rock type and in similar conditions.

TABLE I  
SPECIFIC ENERGY FOR DIFFERENT DRILLING TECHNOLOGIES

Method	Specific Energy(kJ/cm <sup>3</sup> )
High Pressure Water Jet	0.3 - 1.4
Rotary drill [78]	
Surface set Diamond Bit(granite,quartzite)	1.4 - 2
Impregnated Diamond Bit(granite,quartzite)	10
Rotary drill(drag bit)	0.4
Laser drilling	
CO laser	22.8
COIL laser	7.2
CO <sub>2</sub> laser	37.4
Nd:YAG Laser [79, 80]	
Melting(Sandstone & Shale)	2.2
Spallation(Sandstone & Shale)	0.5
Pulsed(Limestone)	12.7
Super pulsed(Limestone)	5.1
Flame Jet (Barre Granite) [81]	8.7-18.2

Rate of penetration can be approximately be calculated using equation 4 [82].

$$\text{Rate of Penetration} = \frac{\text{Power per unit area}}{\text{Specific Energy}} \quad (4)$$

Potential increase in the rate of penetration would lead to a corresponding reduction in the cost of drilling.

Research indicates the inadequacy of the use of specific energy to compare thermal and mechanical methods. Studies conducted by Elahifar et al [83] attempted to compare laser drilling with rotary drilling, using specific energy and rate of penetration, with little success. This was attributed to the inequality of the experiments, such as the comparison of a 2-inch roller cone drill bit to an Nd-YAG laser of 9mm spot size. In addition, other ignored parameters such as the drilled diameter and size of the sample used enhanced the inadequacy of the comparison. These confirmed the results obtained by Graves [84], who challenged the comparison of specific energy, without accounting for the rock type, atmospheric conditions and size-power density relationship. The challenge for research, therefore, is to achieve a close-to-adequate comparison of these methods, as a step towards indicating their significance in the drilling market.

Table II shows comparative data available from various literature sources. Most of these thermal technologies have only been tested at laboratory scale, with simulation of the downhole environment being carried out by several researchers. It would be important for deep drilling experiments to be conducted, in order to be assured of the progress of the technology from laboratory to market.

Certain technologies appear to have higher specific energy despite the potential high rates of penetration in hard rock(Table I & II). It would be important to carry out cost-benefit analysis of these methods to determine their economic viability.

TABLE II  
COMPARISON OF THERMAL DRILLING METHODS(PORTIONS ADAPTED FROM [85])

S/No.	Item	Laser Drilling	Flame jet spallation drilling	Hydrothermal Spallation	SuperDeep-Fusion Drilling	Electro Pulse Boring
1	Diameter of hole	Undisclosed	0.2-0.45m	20 - 25cm	50-200cm	Minimum of $\approx$ 200mm for shallow wells; 0.5-1m for deep wells
2	Volume of material removed	2-4 times the rate of mechanical drilling	undisclosed in literature	175cm <sup>3</sup> /s ( $\approx$ 25cm diameter hole)	4000cm <sup>2</sup> /s (for 1000mm diameter hole)	380cm <sup>3</sup> /s (granite for 300-600 diameter hole); 125cm <sup>3</sup> /pulse
3	Velocity of Drilling (Rate of penetration)	90% faster than mechanical drilling	52ft/hr (for 330m hole)	15.8m/hr	5mm/s	3m/hr (for diameter of 50cm and excavation rate of 0.6m <sup>3</sup> /hr)
4	Types of Rock Drilled	Ultra hard crystalline rocks(Granite, basalt, dolomite, quartzite)	Taconite, Granite	Hard rock, not suitable for sedimentary rocks	Granite	Granite
5	Depth of hole drilled	laboratory stage	should be capable of drilling upto 3km depth	laboratory stage(should be capable of drilling 10-20km depth)	Tests conducted at a quarry(should be capable of drilling 6km)	200m(Initial field study)
6	Cost of Drilling	undisclosed in literature	US\$9/m(for depths between 3-7km)	undisclosed in literature	€3300/m (for 20km pit of 1m diameter; casing cost inclusive)	Estimated at €100/m (diameter of btwn 15-20 for a 6km deep hole)

## V. CONCLUSION

A description of various thermal drilling technologies is presented in this paper. The mode of material removal has been discussed and the current status of the technology discussed. A comparison has been made between the conventional drilling methods and thermal methods, with the clear ability of thermal methods to compete being established.

There is limited data on the deep drilling tests of thermal drilling methods. There needs to be concerted efforts towards deep drilling in order to confirm the laboratory results. Comparative feasibility studies should be conducted on these methods, under similar conditions. It would also be necessary to weigh these methods against the current mechanical methods in use. For this purpose, an adequate comparison mechanism should be developed.

Cost-benefit analysis would also be important in determination of the viability of deep drilling conditions. Development of suitable testing rigs is required, due to the differences between thermal methods and mechanical methods. Knowledge of thermal damage both in the short term (during drilling) or in the long term (as drilling goes deeper) will be essential in prediction of the lifespan of the thermal spallation tools.

Research focus should be placed on the interaction between thermal energy source and the rock, in order to increase understanding of the environment and influences to the drilling process thereof. Entrainment has been noted as a major challenge affecting some thermal methods. Investigations into entrainment effects and methods of ensuring delivery of heat to the rock without dissipation would be of premier importance. The use of modeling and simulation techniques would be useful for this purpose.

Proper control of the process as well as real time data retrieval from the downhole environment would greatly enhance thermal spallation. Design of robust sensory equipment for

accurate measurement at the high temperatures delivered by these methods as well as the harsh downhole environment is, therefore, requisite.

## ACKNOWLEDGMENT

This research is funded through the Mobility to Enhance Training of Engineering Graduates in Africa (METEGA) program and conducted at the University of Botswana.

## REFERENCES

- [1] K. U. Akpedeye, *Advancement on Drilling Technology in Petroleum Industry*. Bachelors thesis, HAMK University of Applied Science, 2010.
- [2] C. Teodoriu and C. Cheuffa, "A Comprehensive Review of Past and Present Drilling Methods With Application To Deep Geothermal Environment," in *Thirty-Sixth Workshop on Geothermal Reservoir Engineering, SGP-TR-191*, Stanford University, Stanford, California, 2011.
- [3] M. Z. Lukawski, B. J. Anderson, C. Augustine, L. E. Capuano, K. F. Beckers, B. Livesay, and J. W. Tester, "Cost analysis of oil, gas, and geothermal well drilling," *Journal of Petroleum Science and Engineering*, vol. 118, pp. 1-14, 2014.
- [4] M. Hatcher, "Research team strikes it rich with a photon drill," *optics.org*, March 2003.
- [5] J. W. Tester, H. J. Herzog, Z. Chen, R. M. Potter, and M. G. Frank, "Prospects for universal geothermal energy from heat mining," *Science & Global Security*, vol. 5, pp. 99-121, 1994.
- [6] D. Vollmar, V. Wittig, and R. Bracke, "Geothermal drilling best practices: The geothermal translation of conventional drilling recommendations-main potential challenges," *International Geothermal Association: Home*, 2013.
- [7] R. A. Kerr, "Looking-Deeply-Into the Earth's Crust in Europe," *Science*, vol. 261, no. 5119, pp. 295-297, 1993.
- [8] L. B. Pierce, K.G. and F. J.T., "Advanced Drilling Systems Study," *Natural gas research, development and demonstration contractors review meeting, Baton Rouge, LA (United States)*, no. June, p. 163, 1996.
- [9] M. Ghanizadeh, M. Vahidi, and E. Esmailnezhad, "A Comprehensive Review of Laser Application in Oil and Gas Industry," in *3rd Iranian Petroleum Engineering Congress*, 1970.
- [10] Rickard W., Bailey A., Pahler M. and Cory S., "Kymera Hybrid Bit Technology Reduces Drilling Cost," in *Proceedings of the Thirty-Ninth Workshop on Geothermal Reservoir Engineering*, (Stanford California), Stanford University, February 24 - 26 2014.

- [11] C. R. Augustine, *Hydrothermal spallation drilling and advanced energy conversion technologies for Engineered Geothermal Systems*. Phd thesis, Massachusetts Institute of Technology, 2009.
- [12] A. Ghassemi, "A review of some rock mechanics issues in geothermal reservoir development," *Geotechnical and Geological Engineering*, vol. 30, no. 3, pp. 647–664, 2012.
- [13] M. J. Schuler, T. Rothenfluh, and P. R. von Rohr, "Numerical analysis of penetration lengths in submerged supercritical water jets," *The Journal of Supercritical Fluids*, vol. 82, pp. 213–220, 2013.
- [14] S. D. Hillson and J. W. Tester, "Heat transfer properties and dissolution behavior of barre granite as applied to hydrothermal jet drilling with chemical enhancement," in *Fortieth Workshop on Geothermal Reservoir Engineering, Stanford University, Stanford, California*, January 26-28 2015.
- [15] J. W. Tester, B. Anderson, A. Batchelor, D. Blackwell, R. DiPippo, E. Drake, J. Garnish, B. Livesay, M. C. Moore, K. Nichols, et al., "The future of geothermal energy: Impact of enhanced geothermal systems (egs) on the united states in the 21st century," *Massachusetts Institute of Technology*, vol. 209, 2006.
- [16] A. A. Martunovich and V. V. Fedorovich, "Electropulse method of holes boring and boring machine," Dec. 26 2000. US Patent 6,164,388.
- [17] W. Foppe, "Method and device for fusion drilling," Sept. 29 2009. US Patent App. 13/122,500.
- [18] W. Foppe, "Superdeep-fusiondrilling," in *Photonics for Deep Geothermal Energy Harvesting, Proceedings Swissphotonics-Workshop*, 2012.
- [19] T. H. Yang, J. Liu, W. C. Zhu, D. Elsworth, L. G. Tham, and C. A. Tang, "A coupled flow-stress-damage model for groundwater outbursts from an underlying aquifer into mining excavations," *International Journal of Rock Mechanics and Mining Sciences*, vol. 44, no. 1, pp. 87–97, 2007.
- [20] C. Vriezina, "Thermal runaway in microwave heated isothermal slabs, cylinders, and spheres," *Journal of Applied physics*, vol. 83, no. 1, pp. 438–442, 1998.
- [21] C. Vriezina, "Thermal profiles and thermal runaway in microwave heated slabs," *Journal of applied physics*, vol. 85, no. 7, pp. 3774–3779, 1999.
- [22] E. Jerby and V. Dikhtiar, "Method and device for drilling, cutting, nailing and joining solid non-conductive materials using microwave radiation," Sept. 5 2000. US Patent 6,114,676.
- [23] A. Ali and S. Bradshaw, "Bonded-particle modelling of microwave-induced damage in ore particles," *Minerals Engineering*, vol. 23, no. 10, pp. 780–790, 2010.
- [24] D. Whittles, S. Kingman, and D. Reddish, "Application of numerical modelling for prediction of the influence of power density on microwave-assisted breakage," *International Journal of Mineral Processing*, vol. 68, no. 1, pp. 71–91, 2003.
- [25] E. Jerby, V. Dikhtyar, O. Aktushev, and U. Groszlick, "The microwave drill," *Science*, vol. 298, no. 5593, pp. 587–589, 2002.
- [26] D. Jones, S. Kingman, D. Whittles, and I. Lowndes, "Understanding microwave assisted breakage," *Minerals engineering*, vol. 18, no. 7, pp. 659–669, 2005.
- [27] D. Jones, S. Kingman, D. Whittles, and I. Lowndes, "The influence of microwave energy delivery method on strength reduction in ore samples," *Chemical Engineering and Processing: Process Intensification*, vol. 46, no. 4, pp. 291–299, 2007.
- [28] R. Meisels, M. Toifl, P. Hartlieb, F. Kuchar, and T. Antretter, "Microwave propagation and absorption and its thermo-mechanical consequences in heterogeneous rocks," *International Journal of Mineral Processing*, vol. 135, pp. 40–51, 2015.
- [29] S. Kingman and N. Rowson, "Microwave treatment of minerals-a review," *Minerals Engineering*, vol. 11, no. 11, pp. 1081–1087, 1998.
- [30] S. Kingman, K. Jackson, A. Cumbane, S. Bradshaw, N. Rowson, and R. Greenwood, "Recent developments in microwave-assisted comminution," *International Journal of Mineral Processing*, vol. 74, no. 1, pp. 71–83, 2004.
- [31] P. Hartlieb, M. Leindl, F. Kuchar, T. Antretter, and P. Moser, "Damage of basalt induced by microwave irradiation," *Minerals Engineering*, vol. 31, pp. 82–89, 2012.
- [32] T. Peinsitt, F. Kuchar, P. Hartlieb, P. Moser, H. Kargl, U. Restner, and N. Sifferlinger, "Microwave heating of dry and water saturated basalt, granite and sandstone," *International Journal of Mining and Mineral Engineering*, vol. 2, no. 1, pp. 18–29, 2010.
- [33] C. Pickles, "Microwaves in extractive metallurgy: Part 2—a review of applications," *Minerals Engineering*, vol. 22, no. 13, pp. 1112–1118, 2009.
- [34] H. Satish, "Exploring microwave assisted rock breakage for possible space mining applications," in *Masters Abstracts International*, vol. 45(03), 2005.
- [35] C. Pickles, "Microwaves in extractive metallurgy: Part 1—review of fundamentals," *Minerals Engineering*, vol. 22, no. 13, pp. 1102–1111, 2009.
- [36] F. W. Preston, "The Spalling of Bricks," *Journal of the American Ceramic Society*, vol. 9, no. 10, pp. 654–658, 1926.
- [37] F. W. Preston and H. E. White, "Observations on Spalling," *Journal of the American Ceramic Society*, vol. 17, no. 1-12, pp. 137–144, 1934.
- [38] T. N. Dey and R. L. Kranz, "Methods for increasing drilling performance of the thermal spallation drilling system," tech. rep., Los Alamos National Lab., NM (USA), 1985.
- [39] R. E. Williams, R. M. Potter, and S. Miska, "Experiments in Thermal Spallation of Various Rocks," *Journal of Energy Resources Technology*, vol. 118, no. 1, pp. 2–8, 1996.
- [40] Z. Xu, C. B. Reed, R. Parker, and R. Graves, "Laser Spallation of Rocks for Oil Well Drilling," in *Proceedings of the 23rd International Congress on Applications of Lasers and Electro-Optics*, pp. 2–7, 2004.
- [41] B. C. Gahan, S. Batarseh, and R. W. Siegfried, "Improving gas well drilling and completion with high energy lasers," *National Energy Technology Laboratory Strategic Center for Natural Gas & Oil, Argonne National Lab., DE-FC26-00NT40917, Des Plaines, Illinois*, 2006.
- [42] R. M. Rauenzahn, *Analysis of Rock Mechanics and Gas Dynamics of Flame-Jet Thermal Spallation Drilling*. Phd thesis, Massachusetts Institute of Technology, 1986.
- [43] R. M. Potter and J. W. Tester, "In a geological formation by spallation; geothermal," June 30, 1988 1998. US Patent 5,771,984.
- [44] J. W. Tester, M. P. Robert, J. E. Mock, C. Peterson, H. Herzog, and J. J. North, "Advanced drilling and its impact on heat mining," in *Proceedings of the World Geothermal Congress, (New Zealand)*, pp. 1385–1390, New Zealand: International Geothermal Association, 1995.
- [45] J. J. Calaman and H. C. Rolseth, "Technical advances expand use of jet-piercing process in taconite industry," in *International symposium on mining research, US Bureau of Mines*, pp. 473–498, 1961.
- [46] J. Browning, "Flame-jet drilling in conway nm. granite," tech. rep., Browning Engineering Company, 1981.
- [47] F. J. R. Silva, D. B. Netto, L. F. F. da Silva, and J. C. R. Placido, "Analysis of the Performance of a Thermal Spallation Device for Rock Drilling," in *Proceedings of the 11th Brazilian Congress of Thermal Sciences and Engineering – ENCIT, (Curitiba, Brazil)*, Brazil Society of Mechanical Sciences and Engineering – ABCM, 2006.
- [48] R. M. Rauenzahn and J. W. Tester, "Rock failure mechanisms of flame-jet thermal spallation drilling - theory and experimental testing," *International Journal of Rock Mechanics and Mining Sciences*, vol. 26, no. 5, pp. 381–399, 1989.
- [49] R. M. Potter, J. M. Potter, and T. W. Wideman, "Laboratory Study and Field Demonstration of Hydrothermal spallation Drilling," *GRC Transactions*, vol. 34, pp. 249–252, 2010.
- [50] R. E. William, "Thermal Spallation Drilling," in *Geothermal Resources Council Symposium, (Kailua-Kona, Hawaii)*, Los Alamos National Laboratory, 1985.
- [51] C. Augustine, J. Potter, R. Potter, and J. W. Tester, "Feasibility of Spallation Drilling in a High Pressure , High-Density , Aqueous Environment : Characterization of Heat Transfer from an H 2 -O 2 Flame Jet," *GRC Transactions*, vol. 31, pp. 241–246, 2007.
- [52] C. Augustine and J. W. Tester, "Hydrothermal flames: From phenomenological experimental demonstrations to quantitative understanding," *Journal of Supercritical Fluids*, vol. 47, pp. 415–430, 2009.
- [53] T. Rothenfluh, *Heat transfer phenomena of supercritical water jets in hydrothermal spallation drilling*. PhD thesis, Diss., Eidgenössische Technische Hochschule ETH Zürich, Nr. 21001, 2013, 2013.
- [54] J. W. Tester and C. Augustine, "Transport Processes in Reacting Hydrothermal Flames with Applications to Military Waste Destruction in Supercritical Water and Geotechnical Rock Excavation," tech. rep., U.S. Army Research Office, 2009.
- [55] P. Stathopoulos, T. Meier, and P. R. von Rohr, "Hydrothermal flame impingement experiments. combustion chamber design and impingement temperature profiles," *The Journal of Supercritical Fluids*, vol. 89, pp. 48–57, 2014.
- [56] Resource Technology Incorporated, "A Technical and Economic Evaluation of Thermal Spallation Drilling Technology," tech. rep., Sandia National Laboratories, Albuquerque, New Mexico, Oklahoma, 1984.
- [57] P. R. Von Rohr, T. Rothenfluh, and M. Schuler, "Rock drilling in great depths by thermal fragmentation using highly exothermic reactions evolving in the environment of a water-based drilling fluid," December 22 2009. US Patent App. 13/141,349.
- [58] T. W. Wideman, N. Sazdanoff, J. Unzelman-Langsdorf, and J. M. Potter, "Hydrothermal spallation for the treatment of hydrothermal and EGS wells: A cost-effective method for substantially increasing reservoir

- production and flow rates,” *GRC Transactions*, vol. 35, pp. 283–285, 2011.
- [59] L. U. Qieni, G. Baozhen, Y. Wenda, and Z. Yimo, “A Method for Measuring the Thickness of Transparent Oil film on Water Surface using Laser Trigonometry,” *Applied Optics*, vol. 45, pp. 4916–4926, 2006.
- [60] M. A. Gondal, T. Hussain, Z. H. Yamani, and M. A. Baig, “Detection of heavy metals in Arabian crude oil residue using laser induced breakdown spectroscopy,” *Talanta*, vol. 69, no. 5, pp. 1072–1078, 2006.
- [61] Z. Y. Abdulrazag, A. S. Shedid, and H. Alkashaf, “A New Technique for treatment of permeability damage due to asphaltene deposition using laser technology,” *Journal of Petroleum Science and Engineering*, vol. 59, no. 3, pp. 300–308, 2007.
- [62] R. M. Graves and D. G. O’Brien, “StarWars Laser Technology Applied to Drilling and Completing Gas Wells,” in *SPE Rocky Mountain regional meeting*, pp. 131–140, 1999.
- [63] B. O. Faircloth, M. S. Zediker, C. C. Rinzler, Y. Koblick, and J. F. Moxley, “Methods and apparatus for delivering high power laser energy to a surface,” April 23 2013. US Patent 8,424,617.
- [64] M. Olaleye, “A review of light amplification by stimulated emission of radiation in oil and gas well drilling,” *Mining Science and Technology*, vol. 20, no. 5, pp. 752–757, 2010.
- [65] A. W. Adeniji, “The Applications of Laser Technology in Downhole Operations - A Review,” in *IPTC 2014: International Petroleum Technology Conference*, 2014.
- [66] J. Hecht, “High-power lasers: Fiber lasers drill for oil,” *Laser Focus World: Photonics Technologies & Solutions for Technical Professionals Worldwide*, 2012.
- [67] I. A. Salehi, B. C. Gahan, and S. Batarseh, “Laser drilling—drilling with the power of light,” tech. rep., Institute of Gas Technology, 2007.
- [68] S. I. Batarseh, B. C. Gahan, B. C. Sharma, and I. G. Sherif, “Deep hole penetration of rock for oil production using ytterbium fiber laser,” *High-Power Laser Ablation V*, vol. 5448, pp. 818–826, 2004.
- [69] T. Kobayashi, S. Kubo, M. Ichikawa, and N. Masahiro, “Drilling a 2-inch in Diameter Hole in Granites Submerged in Water by CO<sub>2</sub>,” in *SPE/IADC Drilling Conference and Exhibition*, Society of Petroleum Engineers, 2009.
- [70] S. I. Batarseh, B. C. Gahan, B. C. Sharma, and S. I. Gowelly, “Deep hole penetration of rock for oil production using ytterbium fiber laser,” in *High-Power Laser Ablation 2004*, pp. 818–826, International Society for Optics and Photonics, 2004.
- [71] C. C. Rinzler, M. S. Zediker, B. O. Faircloth, and J. F. Moxley, “Methods and apparatus for removal and control of material in laser drilling of a borehole,” January 28 2014. US Patent 8,636,085.
- [72] C. Reed, Z. Xu, R. Parker, B. Gahan, S. Batarseh, R. Graves, H. Figueroa, and W. Deeg, “Application of high powered lasers to drilling and completing deep wells,” in *23rd International Congress on Application of Lasers and Electro-Optics*, 2003.
- [73] M. Ahmadi, M. Erfan, M. Torkamany, and G. A. Safian, “The effect of interaction time and saturation of rock on specific energy in nd: Yag laser perforating,” *Optics & Laser Technology*, vol. 43, no. 1, pp. 226–231, 2011.
- [74] B. C. Gahan *et al.*, “Laser drilling - drilling with the power of light: High energy laser perforation and completion techniques,” *Annual Technical Progress Report by the Gas Technology Institute, to the Department of Energy*, 2006.
- [75] J. Allgood, “Tunnel excavation with electrically generated shock waves,” October 8 1974. US Patent 3,840,270.
- [76] H. O. Schiegg, A. Rødland, G. Zhu, and D. A. Yuen, “Electro-pulse-boring (EPB): Novel super-deep drilling technology for low cost electricity,” *Journal of Earth Science*, vol. 26, no. 1, pp. 37–46, 2015.
- [77] A. Rodland, “Deep geothermal energy; photonics for harvesting,” in *Photonics for Deep Geothermal Energy Harvesting, Proceedings Swissphotonics-Workshop*, 2012.
- [78] J. Kollé, “A comparison of water jet, abrasive jet and rotary diamond drilling in hard rock,” *Tempress Technologies Inc*, pp. 1–8, 1999.
- [79] Z. Xu, C. Reed, G. Konercki, R. Parker, B. Gahan, S. Batarseh, R. Graves, H. Figueroa, and N. Skinner, “Specific energy for pulsed laser rock drilling,” *Journal of Laser Applications*, vol. 15, no. 1, pp. 25–30, 2003.
- [80] Z. Xu, C. Reed, R. Parker, B. Gahan, R. Graves, S. Batarsah, and H. Figueroa, “Laser rock drilling by a super-pulsed co2 laser beam,” *a manuscript created for the Department of Energy, while the date of the publication is unknown, it is believed to be prior to Aug*, vol. 19, p. 9, 2009.
- [81] D. Dreesen and R. Bretz, “Coiled-tubing-deployed hard rock thermal spallation cavity maker,” tech. rep., Department of Energy’s National Energy Technology Laboratory, 2005.
- [82] B. C. Gahan, R. A. Parker, S. Batarseh, H. Figueroa, C. B. Reed, Z. Xu, *et al.*, “Laser drilling: determination of energy required to remove rock,” in *SPE Annual Technical Conference and Exhibition*, Society of Petroleum Engineers, 2001.
- [83] B. Elahifar, A. Esmaili, M. Prohaska, and G. Thonhauser, “An Energy Based Comparison of Alternative Drilling Methods,” in *SPE/IADC Middle East Drilling Technology Conference and Exhibition*, Society of Petroleum Engineers, 2011.
- [84] R. M. Graves, A. Araya, B. C. Gahan, and R. A. Parker, “Comparison of Specific Energy Between Drilling With High Power Lasers and Other Drilling Methods,” in *SPE Annual Technical Conference and Exhibition, San Antonio, Texas*, Society of Petroleum Engineers, 29 September - 2 October, 2002.
- [85] various, “Swissphotonics workshop,” in *Proceedings of the Swissphotonics-Workshop: Photonics for Deep Geothermal Energy Harvesting*, HSR University of Applied Sciences Rapperswil, 2012.



# The Implications of Geology and Structure on Iron Ore Mining at Wanjala Mine, Taita-Taveta County, Kenya

Keoko K. Peter, Bett K. Gilbert and Rop K. Bernard

**Abstract:** This paper explains how geological attributes and structure of rocks dictates mining techniques applicable at Wanjala Mines. Mineral and ore deposits occurrence is associated with other geological materials that influence their physical, mineralogical and geochemical properties hence defining the kind of mining technique and beneficiation method(s). Associated and/ or paragenetic sequence affects the ore grades such as cut-off grade which may further affect the mineable ore reserve. The quantity of recoverable iron ore in wanjala Mines is a function of the geology and the associated minerals whether elluvial, vein or lode, brecciated or fractured and/ or massive deposit. At Wanjala Mines, the geology and mineralogy has less complex nature that may affect iron ore mining. Iron ore occurrence is in two forms elluvial and lode iron ore. The geographical distribution of iron ore and intensity of their anomalies dictate a biased mode of extraction for elluvial and a different method to exploit the reef iron ore; say mobile units and open pit mining respectively. Beneficiation also necessitated plant optimization methods on how to handle different sizes of materials.

**Key words:** Geology, mineralogy, geochemical, elluvial, lode, Wanjala Mine, Mining.

## I. INTRODUCTION

Mining of iron ore is partly or fully influenced by one or combination of several factors among them being topography, geology and geologic structure, hydrogeological conditions as well as soil and general ground stability. The implications of the aforementioned factors to the whole mining process [1] include choice of and equipment specifications, production rate, operating costs, stripping ratio and haul roads. Additionally, the structure of the rocks, that is dip and strike are key elements that determine the overall pit and bench geometries. The quality and the quantity of the net iron ore mined are determined by factors such as the gangue materials. Mineral [6] occurrence of iron ore in Kenya has been identified but non-extensive research has been done to prove their commercial and geological attributes that may inform investors and/or government on the possible ways to not only

mine but add value as well as technologies to mine and/ or process to a final product.

## II. JUSTIFICATION OF THE RESEARCH

Kenya's Vision 2030 is and will be realized when factual data that feeds industrialization is available for decision making. EAC interest on singular investment on steel smelting plant is good gesture of possibility and rationale for futuristic economy that is stable and sufficient. Therefore, research into available and quality of raw materials and extraction mechanisms alongside technologies that will apply is the key determinant. This research adds knowledge to geological formation and attitude and how they directly affect mining and processing techniques

This paper aims to provide a relationship between geological formation of iron ore at the mine and their implications to the types and mechanism of extracting and beneficiation of iron ore.

## III. LITERATURE REVIEW

The Wanjala iron ore is a medium grade (<62% Fe) deposit that occurs in two forms which include the reefs and the elluvial deposits [2]. The latter is as a result of collisional tectonics that included folding and uplift, shearing and brecciating. Following massive tectonic forces, iron ore veins were mechanically fragmented hence forming the abbrecciated sections on lateral veins and further up-thrown iron ore gave rise to elluvial iron ore deposit. Alluvial iron ore covers areas near and/ or along the main reefs and assumed the topographic surface at that time. The depths of occurrence of the two types of deposits vary from one point to the other due to the folding pattern which formed anticline and syncline. These resulted in uplift and sinking of the veins on some sections and other areas the reefs as well as the elluvial deposits are exposed to the surface. The reefs are shallow to deep-seated in areas that suffered extensional tectonics. Where iron ore vein is deep, a non-quantifiable alluvial iron ore occur.

Iron ore deposit is non-related with host rocks though there exists sharp contact between the metallic and non-metallic ore, for instance, iron ore deposit juts into massive quartzite or hornblende in other sections with deep-seated ore) occurrence with little geochemical interchanges of minerals. This is the reason why iron ore deposit mineralogy absolutely differs from that of the host rocks. Lack of defined metallic ore zoning shows that the original protolith was monomineralic in nature only changes came from new geological formation which created a break in the continuity of occurrence over the

Bett G, Department of Mining, Materials and Petroleum Engineering, J.K.U.A.T (phone: +254731204544; email: [bett86.kip@gmail.com](mailto:bett86.kip@gmail.com)).

P. Keoko, Department of Geology, UoN (phone: +254715755185; email: [keokopeter@gmail.com](mailto:keokopeter@gmail.com)).

B. K. Rop, Department of Mining, Materials and Petroleum Engineering, J.K.U.A.T (phone: +2547022876297; email: [drropben@gmail.com](mailto:drropben@gmail.com)).

area. Moreover, the deposits are structurally and topographically controlled, that is, for iron ore reefs, the visible brecciation, joints and fractures are as a result of brittle deformation caused by compressional and extensional tectonics. Additionally, the reefs' general strike is NW-SE direction and dip towards 60 degrees NE. The elluvial deposit assumes the topographic nature of the area. Referring to the nature of mineralization, both the elluvial and reef ore are hard, compact and resistant to weathering. The deposit and host rocks relationship shows a magmatic-metamorphic genetic model, that is, a magmatic process that produced huge amounts iron pyrites which after eruption formed a sedimentary exhalative iron pyrite deposit on top of basaltic rocks. These were then metamorphosed under oxidizing conditions to form iron ore (magnetite) and ortho-amphibolite respectively.

#### IV. GEOLOGICAL CHARACTERIZATION OF IRON ORE DEPOSITS

The geology and structure that resulted from thermo-tectonic phases of <sup>1101</sup> Neo-Proterozoic Mozambique belt evolution have had implications on the mining operations of iron ore deposit at Wanjala Mine. The geology consists of quartzite, quartz-feldspathic gneiss, mica schists, amphibolite, hornblende gneiss, calcrete and iron-rich laterite. The minimum and maximum strike and dip range between N5°W and 30°NE to N50°W and 65°NE respectively. The iron ore reefs at any locality within the mining site assume the strike and dip of the rocks that enclose them. The distinct physical and mechanical properties of both the footwall and hanging wall and the iron ore reefs as well as the elluvial iron ore deposit result in either ease or difficulty with which they are mined. The major implications are that the strip ratio for iron ore reefs which are thin and geologically and structurally set between large masses of footwall and hanging wall is higher than that experienced in the excavation and screening of elluvial deposit. The iron ore reefs are sometimes too thin as compared to footwall and hanging wall rock units, irregular and since they extend down the ground, economic extraction becomes difficult as shown in Figure 1 below. The rapid increase of the amount of overburden to be handled also imposes economic limits and/or constraints.



Figure 1 Reef iron ore

The elluvial deposit whose non-ore material is quartzite is easier and cheaper to mine depending on the ratio of the ore to quartzite and the depth of the top soil at a certain exaction point as illustrated in Figure 2 below.



Figure 2 Elluvial iron ore geo-distribution.

Contrary to this, mining the iron ore reefs is a challenging process simply because of the hanging wall geologic units. The widths of iron ore reef range from about thirty to hundred centimeters. In this scenario, removal of huge masses of hanging wall materials to only get low iron ore tonnage is expensive and uneconomical for mining at greater depth.

#### V. IMPLICATIONS TO MINING

Geological characterization affect in the following ways:

- 1. Production rate:** the rate of production or excavation of elluvial iron ore deposit is fast and efficient simply because the topographical level of the ground is flat making it easy for earth-moving machines such as mobile crushing and screening plants to move from one mining block/ site to another. The depth at which elluvial deposit occur is shallow therefore, a crawler excavator can strip the overburden, extract crude iron ore and load to mobile screening machine or dumper truck. Daily

production rate will be high when the ratio of iron ore occurrence is bigger in proportion to quartzite (or gangue material). On the other hand, lode mining has similar difficulty if the hanging wall is huge requiring intense development of the pit to extract the iron ore vein(s). Additionally, the width of the vein at given depth ranges from two to five metres as compared to the mass consolidated volume of waste material. This poses a challenge to the [8] economics of mining operations. The dipping angle and direction of strike of the veins means the deeper it becomes more difficult, time consuming and costly as well as not commercially viable to continue mining using surface methods. [9] Depending on the volume of the deposit after the 20m depth, it may be inappropriate to undergo underground mining (if positive results are achieved after doing further exploration).



Figure 3 Excavation of a pit, development method

**2. The choice of mining machines and equipments:** Iron ore deposit requires two distinct methods of handling because of its uniqueness in occurrence. Elluvial mining requires a mobile type of machinery and equipment such as mobile screening units that help remove huge bulk of material that others would have been handled at the plant, say fine dust or soil mass. Oversize material that requires crushing unit would be isolated from the standard sizes/ range as per the market to raw iron. Gangue material that forms the hanging wall is mainly quartzite and hornblende [4] which is easy to extract compared to blended type of occurrence since it is non-magnetic.

**3. Bench Setting or configuration:** [3] Bench and pit geometry forms the overall mining development. Mechanical properties of the geological units are quite good and therefore provide a stable ground for construction of benches. Due to these features they provide a suitable ground for mining and development on the working benches and faces of the pit. Surface mine design of the pit depends on the geometry of the

ore body which determines working and non-working flanks and informs the stripping ratio and efficiency of mining activities, see Figure 4 below.



Figure 4 a bulldozer pushing loose material and developing bench and access to rich iron vein.

**4. Haul roads:** [1] Haulage and haul roads are integral part of mining operations. Mining at Wanjala Mine has reached a shallow depth of barely 20metres. It therefore, does not pose a challenge in construction or development of ramps and high walls. [10]The slope of access road is necessary for trucks and machines to enable movement in and out of the pit as seen in figure 5.



Figure 5 Access road into the pit

In addition, the gradient and geometry of the [1] access roads is still at stable configuration. The geo-position of the haul and access roads is dictated by the nature of ore body and the country rocks.

## VI. CONCLUSION

Mine designing process requires that correct data on the geometry of the deposit such as size, shape, strike, dip, and quality or grade of the ore has to be obtained. This will provide an effective way of mining, processing, material handling and required machinery.

Constant acquisition of the information on the deposit such

as mineralization, rock types, the physical and mechanical properties and geometry are important for selection of mining method as well as general project economic evaluations.

#### ACKNOWLEDGEMENT

I wish to acknowledge Wanjala Mining Co. Ltd, R.K Sanghani (Mr. Kaburu), Mr. Joseph Mutwanthei (Resident geologist) and my family for their contribution, prayers and support in this research.

#### REFERENCES

- [1] Anon., *Illustrated Surface Mining Methods*, Skelly and Loy, McGraw-Hill, New York, 1979, pp. 10–17, 30–33.
- [2] Bett Gilbert, Baru K Jidruph, Kabugu and Dr. Rop B. *Beneficiation of Iron Ore in Kishushe for the Steel Manufacturing Plant*.
- [3] Hartman, H. L., *Introductory Mining Engineering*, Wiley, New York, 1987, pp. 177–187.
- [4] Hudson, J.A. and Harrison, J.P.: *Engineering Rock Mechanics*. Pergamon, 1997, pp. 270–72, 284.
- [5] Hustrulid, W. and Kuchta, M., *Open Pit Mine Planning & Design*. A.A. Balkema,
- [6] J. Walsh, Revised Edition, 2007 Bulletin 11, *Geological Survey of Kenya*, Pg 35-37.
- [7] Lewis, R.S. and Clark, G.B.: *Elements of Mining*. 3<sup>rd</sup> Edition; Wiley, New York, 1964, pp. 7–10.
- [8] Matti, H., *Rock Excavation Handbook*. Sandvik – Tamrock, 1999, pp. 20–52.
- [9] O Faircheallaigh, C., *Financial Failures in Mining Resource Policy*, 1985, Butterworths, Sydney, Australia.
- [10] Peters W, *Exploration and Mining Geology*, 1987, 2<sup>nd</sup> Edition, Wiley New York.
- [11] Rzhnevsky, V.V., *Opencast Mining – Technology and integrated Mechanization*. Mir Publishers, Moscow, 1987, pp. 12–92; 112–49; 300–07; 374–77.
- [12] Rzhnevsky, V. V., *Opencast Mining Unit Operations*. Mir Publishers, Moscow, 1985, pp. 117.

# Investigation of Slow Light in Single Mode Fibres (SMF) for the Basis of Stimulated Brillouin Scattering and the Application in Sensing.

Douglas Osiemo, G Mosoti, Dr. Muguro and Dr. David Waswa

**Abstract**— Stimulated Brillouin scattering is one of the hottest technologies used to generate slow light in optical fibres, which is also a simplest and most applicable method. In this paper we have investigated slow light based on Stimulated Brillouin Scattering theoretically using optisystem in SMF\_ Standard, Large area, Reach and Reduced slope. The effect of varying pump power and temperature on the signal were investigated. Variation of delay of the signal with pump power and temperature in SBS slow light was studied. Theoretical simulation has shown that there is signal delay with pump power and temperature with reduced slope fibre being the best for slow light. Since SBS slow light is temperature dependent, temperature sensing can be realized by measuring the time delay. Thus fibre-sensing can be possible by measuring the delay of the probe pulse. This phenomenon can be put to use in smart optical sensing mechanism for distributed measurement since the scattered light depends on external parameters such as temperature, the pressure or the strain applied to the fibre and modern telecommunication. This study is of great significance in designing of Brillouin based sensors for distributed sensing.

**Keywords**—nonlinear optics, single mode fibre (SMF), Stimulated Brillouin Scattering (SBS), and slow light.

## I. INTRODUCTION

Slow light refers to the reduction of group velocity for optical pulses propagating through a dispersive material and can be achieved by changing the velocity of propagation of pulses by causing dispersion inside the material which provides continuous alteration of group velocity of light pulses. In a slow light medium the pump wave creates a frequency shifted Stokes gain, this gain resonance lead to a phase change which in turn results in a change of the group index. Slow light has been coined in modern science for a phenomenon that allows a light signal to propagate with reduced group velocity. This technique has been rapidly developed for many potential applications for which slow light has been identified as a solution. Successful experiments on slow light propagation has been demonstrated with astonishing control of the group velocity, namely the velocity at which a signal travels in a material from nearly stopping it to exceeding the vacuum velocity  $c$  or even reaching negative velocities. So far, slow light has been realized in wide variety of materials with different physical phenomena, i.e. crystalline solids [1], semiconductors [2], optical fibres [3], photonic structures [4]

Douglas Osiemo Department of Physics, University of Eldoret (UoE)  
Laser and Fibre Optics Research Group. Mobile phone no.: 0724124066  
[douglasosiemo@yahoo.com](mailto:douglasosiemo@yahoo.com) or [daggy.do@gmail.com](mailto:daggy.do@gmail.com)

and ultra-cold atomic gases [5]. As matter of fact, the possibility to exert an optical control on a group velocity of an optical signal has modern applications such as: all-optical signal processing, optical buffering and data synchronization. Therefore, scientific challenge to generate practical control of signal delay remains fascinating. A significant step towards real applications was achieved by Song et al. in 2005 when slow light was experimentally and efficiently realized in an optical fibre using stimulated Brillouin scattering (SBS) [3]. To date, Brillouin slow light systems have proved to be an unmatched and unprecedented flexible timing as a result of their unique spectral tailoring capability. This makes Brillouin slow light attractive delay line in high flexibility of SBS, essentially the possibility to be achieved in any type of optical fibre and at any wavelength. Moreover, it presents some inherent advantages: room temperature operation, high potential for large signal bandwidths, simple tabletop configuration and seamless integration in fibre optic communication systems.

## II. THEORY OF SBS

SBS was first observed in 1964 and it manifests through the generation of Stokes wave whose frequency is downshifted from that of the incident light by an amount set by the nonlinear medium. This process can be described classically as a nonlinear interaction between the pump and Stokes fields through an acoustic wave. The pump field generates an acoustic wave through the process of electrostriction. The backscattered wave superimposes with the pump wave which built up an electrical interference field. Due to the process of electrostriction the interference pattern leads to a periodical density modulation of the medium. The density modulation can be seen as a modulation of the refractive index which acts like a Bragg Grating. If the Bragg conditions is fulfilled power wave is backscattered. This leads to stronger density modulation which in turn exponentially increases the Stokes wave. The process continues and more and more optical power of the pump wave is backscattered and transferable to the Stokes wave. Scattered light is downshifted in frequency because of the Doppler shift associated with grating moving at the acoustic velocity  $v_A$ . The frequency of the reflected beam is slightly lower than that of the incident beam and this frequency difference corresponds to the frequency of emitted phonons.

The process of SBS is therefore the interaction of two counter-propagating waves a strong pump wave and a weak

probe wave. If a particular phase matching is satisfied that is  $f_{\text{pump}} = f_{\text{probe}} + v_B$  an acoustic wave is generated which scatter photons from pump to probe wave, stimulating the process.

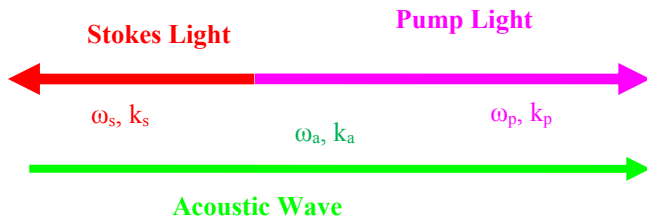

Fig. 1: Brillouin scattering process

The total energy and momentum must be conserved during this process. Quantum mechanically, the incident photon energy is share between the scattered photon and acoustic phonon. This can be represented by the following relations between the wave vectors and frequencies of three waves

$$\Omega = \omega_p - \omega_s \quad (1)$$

$$k_A = k_p - k_s \quad (2)$$

where  $\omega_p$  and  $\omega_s$  are frequencies and  $k_p$  and  $k_s$  are the wave vectors of pump and Stokes waves respectively.  $\Omega$  and  $k_A$  are the frequency and wave vector of the acoustic wave.

SBS occurs only in the backward direction with the Brillouin shift given by [6];

$$V_B = \frac{\Omega_B}{2\pi} = \frac{2nv_A}{\lambda_p}$$

Where  $n$  is the refractive index,  $v_A$  is acoustic velocity and  $\lambda_p$  is pump wavelength. As the incident power in a fibre is increased, the increase in Stokes power is slow in the initial stage due to spontaneous scattering and when the pump is increased further, it may lead to an exponential growth of the Stokes power.

### III. REFRACTIVE INDEX AND KRAMERS-KRONIG RELATIONS

The change of velocities of light is bound to oscillations of material particles. This process is represented by the refractive index  $n$  which depends on the material itself.

The most common expression of the KKR is [7]

$$n(\omega) = 1 + \frac{c}{\pi} \int_0^\infty \frac{\alpha(\omega')}{\omega'^2 - \omega^2} d\omega' \quad (3)$$

$$\alpha(\omega) = -\frac{4\omega^2}{\pi c} \int_0^\infty \frac{n(\omega') - 1}{\omega'^2 - \omega^2} d\omega' \quad (4)$$

Within the full width at half maximum (FWHM) band width the absorption spectrum leads to a strong anomalous dispersion where the refractive index has a negative slope. Hence, the group index will be decreased and the group velocity will be increased. In contrast to this, a peak or gain spectrum would lead to a strong normal dispersion where the

group index is increased and group velocity is decreased. Thus, the KKR show that a strong material resonance, which results in amplification or absorption processes, produces a large dispersion which is necessary for slow or fast light. Such a feature is the basis of many methods for group velocity alteration.

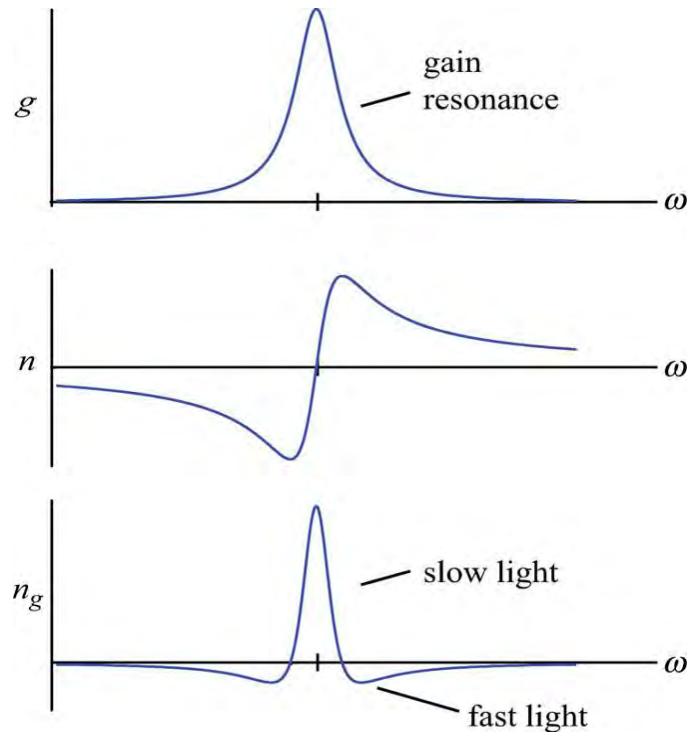

Fig. 2: Lorentzian gain peak and the dispersion profile of the refractive index  $n$  and group index  $n_g$  associated with the gain spectrum by the Kramers-Kronig relations.

### IV. BRILLOUIN SLOW LIGHT IN OPTICAL FIBRES

Slow light scheme exploit abrupt phase index variation near narrowband spectral resonance of optical media that induces large group index change based on the Kramers-Kronig relation. Brillouin slow light in optical fibers applies narrowband Brillouin gain for control of the group index. For an optical wave propagating in the direction along an optical fiber provides a narrowband Brillouin gain to counter-propagating signal of specific optical frequency (Stokes) by SBS process. The Lorentzian-shaped Brillouin gain induces sudden change of  $\Delta n$  and  $\Delta n_g$ . The induced time delay is expressed in the form

$$\Delta T = \frac{g_B L}{2\pi} \cdot \frac{I_p}{\Delta v_B} = \frac{G}{2\pi \Delta v_B} \quad (5)$$

where  $L$  is the length of the fiber and  $G$  is the exponent of the Brillouin gain. From the equation time delay linearly dependent on the pump power. Since  $\Delta n_g$  only depends on the pump power one can achieve large variation of group velocity if a short length of the fibre is used. Slow light can be achieved by changing the velocity of propagation of pulses by

causing dispersion inside the material which provides continuous alteration of group velocity of light pulses. Large normal dispersion takes place at the center of the resonance, which leads to an increase of group index and therefore, a reduction of group velocity [17]. Group index and group velocity are the main basis for time delay.

Thus the group delay is given by

$$t_g = \frac{L}{v_g} = \frac{Ln_g}{c} \quad (6)$$

When the frequency of the signal beam is tuned to Stokes line, that is, down-shifted by the Brillouin frequency  $\Omega_B$  from frequency of the pump beam, the opto-acoustic coupling becomes strong and light from the pump beam is efficiently scattered into the signal beam, inducing a gain resonance and giving rise to a variation in the refractive index in a narrow frequency range around the resonance frequency, which results in small  $v_g$  for the signal beam. Brillouin slow light was readily realized in standard optical fibres with a simple bench top configuration [18]. Moreover, its room-temperature operation at any wavelength has received tremendous interest from the optical communication society for fascinating potential applications such as all-optical delay lines, optical buffers and signal synchronizations.

## V. SBS BASED SENSORS

Since demonstration of strain dependence of Brillouin shift in an optical fibre distributed sensors of temperature and strain based on SBS has been established. An attractive feature of SBS based sensors stems from the use of standard telecommunication grade optical fiber sensor head. These sensors are used where distributed measurement on large structures is required e.g. found in the strain monitoring of load-bearing structures in civil engineering, temperature monitoring in boilers, pressure vessels and high voltage transformers, pipeline leakage detection. A general classification may be operated among SBS-based sensor configurations, based on the technique applied for resolving the Brillouin frequency shift over fibre length. The basic idea underlying the use of SBS for fiber sensors is understood the Brillouin frequency shift relation

$$v_B = \frac{2nv_a}{\lambda_p} \quad (7)$$

As the Brillouin frequency shift depends on both the effective refractive index of the fibre mode and the velocity of acoustic waves within the fibre, it changes whenever these quantities change in response to local environment variation and can be used to deduce the temperature and strain along the fibre.

## VI. SIMULATION SETUP

The setup to realize a Brillouin based slow light, as shown in Fig. 3 is simple and requires only standard telecommunication components. The simulation set up consists of three major parts: a system for optical pulse generation, a pump system to

produce SBS slow light and a measurement system to measure delayed pulses. SL pump at wavelength of 1552nm is used as pump source. The Isolator is used to prevent back-reflection. From the opposite side of the slow light medium the SL pump wave was launched into the fibre to counter-propagate with Stokes signal to introduce SBS slow light. The pump Stokes frequency inside the slow light medium creates a Brillouin gain which leads to amplification and delay of the signal pulses.

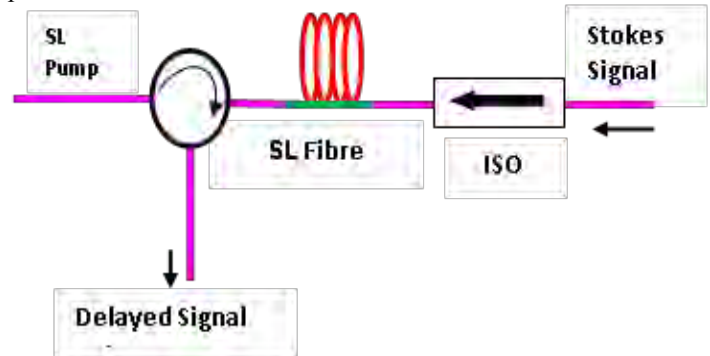
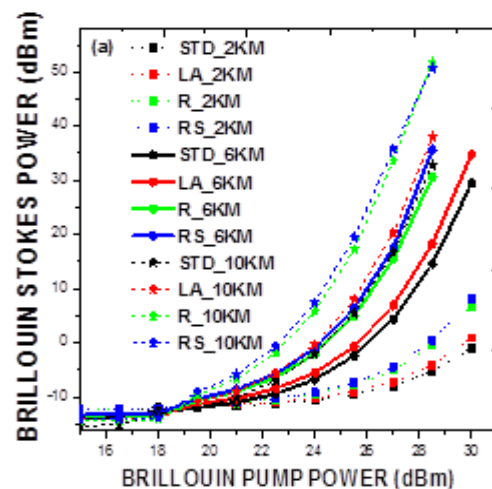

Fig. 3: Simulation setup for observing SBS slow light. ISO: Isolator, SL: slow light.

The length, input power, and temperature for standard fibre, large area fibre, reach fibre and reduced slope fibre were varied and their effect on the output signal measured. The measurement for temperature was taken from 300K to 380K.

## VII. RESULTS AND DISCUSSION

### A. Stokes Power and Pump Power in Different Type of Fibre at given Lengths



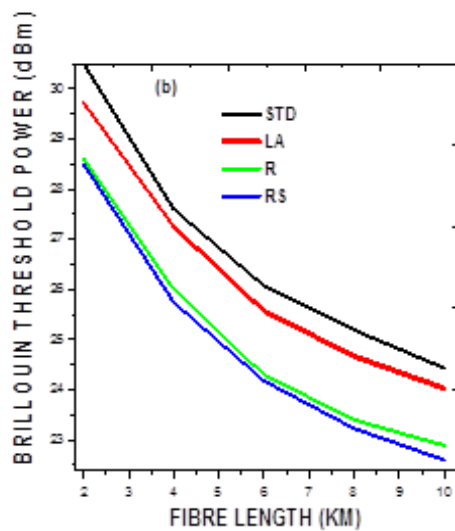
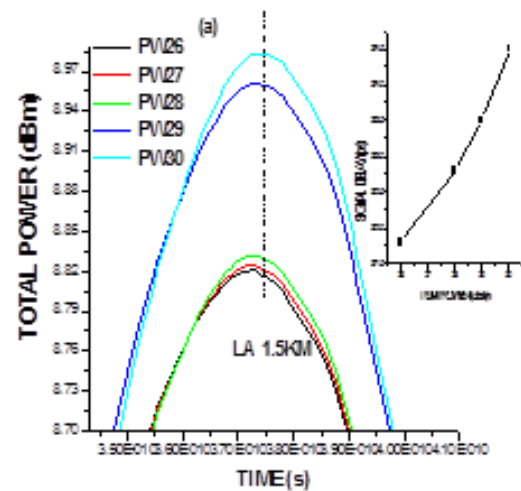
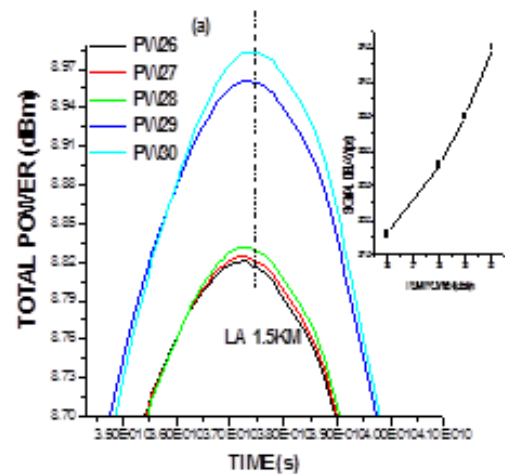

Fig. 4: (a) Brillouin Stokes power as a function of Brillouin pump power for different single mode fibres at probe signal power of -10 dBm. (b) Brillouin threshold power as function of fibre length for SMF\_ reduced slope (RS), large area (LA), standard (STD) and reach (R).

It can be noted from Fig. 4 (a) that increasing the pump power for all fibres, the backward scattered Stokes wave power increases. This is because of Brillouin Scattering, an effect in optical fibre where an appreciable amount of input power is back-reflected within the fibre leading to strong nonlinear optical gain for the backscattered wave. At low pump power, the Stokes wave has a slow growth in a backward direction, resulting in a relatively long effective length hence, the SBS shows no real gain and is very small and the transmitted power experiences only linear loss of the fibre. When threshold power is reached, the SBS power grows exponentially and the pump power is depleted due to its conversion to the backward scattered Stokes wave. Fig. 4 (b) shows that threshold power decreases from 29.5 to 22.5 dBm with the increment of fibre length from 2km to 10km respectively. Since Brillouin threshold depends on effective length which is a function of fibre length then its increase causes a corresponding decrease in the threshold. Threshold power for standard fibre is higher compared to large area (LA), reach (R) and Reduced slope (RS) fibre. This is due to low interaction in standard fibre since it has the largest effective area hence, more pump power is required for the process.

### B. Effect of pump power on signal delay





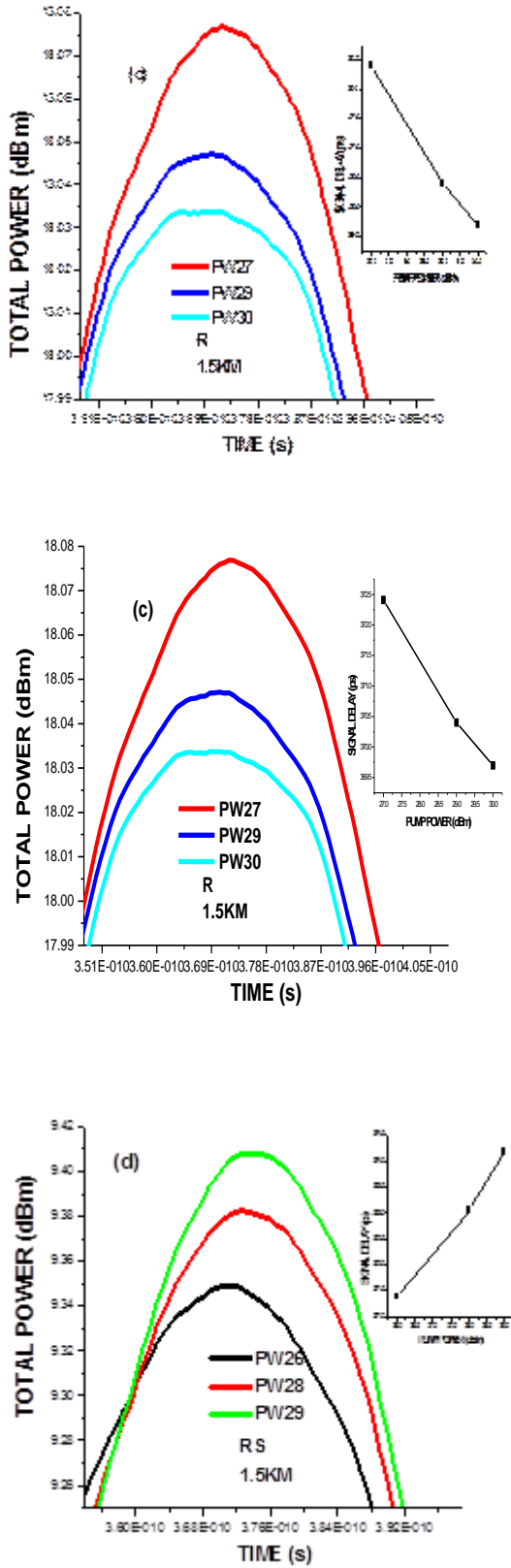

Fig. 5: Variation of time with power for different input power for 1.5km SMF (a) Large Area signal delay 2.4ps (b) Standard

fibre signal delay 3.5ps (c) Reach signal advancement 2.9 ps and (d)Reduced Slope signal delay 3ps.

The delay obtained for varying power from 26dBm to 30dBm for LA, STD and RS is 2.4ps, 3.5ps, and 3ps respectively, whereas there is signal advancement of 2.9ps for Reach fibre.

### C. Temperature and Slow Light

During SBS process, the beating between the pump and Stokes waves creates a modified density change. This density variation is associated with a mechanical acoustic wave; and it may be affected by local temperature, strain and vibration which induce changes in the fibre effective refractive index and sound velocity. The higher the temperature of the fibre, the more the excited molecules will be encountered within the fibre. Because of these temperature dependence, the relative strength of the signal can be used to calculate the temperature at a point of scattering.

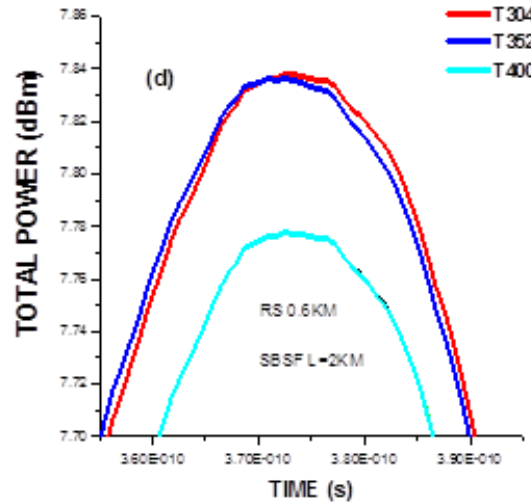

Fig. 6: Variation of time with power for different temperature for 0.6km SMF\_Reduced Slope. The delay for RS is 1.6ps.

The fundamental principle here is the temperature dependence of the Brillouin frequency shift in the fibre, hence, the delay time of an input probe pulse as a result of SBS-based slow light. When temperature is changed, the probe frequency will no longer be aligned to the Stokes downshift frequency, leading to different values of  $\delta$  and hence different probe delays.

$$\Delta t = \left( \frac{g_p L P_p}{\Gamma_B A_{eff}} \right) \frac{1 - \delta^2}{(1 + \delta^2)^2}, \quad \delta = \frac{\Delta \Omega}{\left( \Gamma_B / 2 \right)} \quad (8)$$

where  $\delta$  is the temperature-dependent parameter. Temperature sensitivity of the delay for RS is 0.0333psK<sup>-1</sup>. Temperature change causes delay in RS, this means that RS can be used as temperature sensor by measuring the delay.

## VIII. CONCLUSION

Since temperature causes signal delay and affect Stokes power directly, distributed sensing for temperature can then be realized by measuring the peak of the delayed signal. Change in the Brillouin frequency shift of silica fibres can be advantageously utilized for temperature sensing. Using time domain analysis of the probe pulse, a new fibre sensor interrogation system can be achieved with SBS slow light. The temperature sensing approach has been demonstrated in a 600m SMF and 1.5km. It is worth noting that SBS slow light scheme is potentially useful for sensing along the fibre. By tuning the delay between the SL pump and probe pulses, one can select a particular section of the fibre to be monitored. As a result, dynamic profiling of the temperature can be achieved along the whole fibre. The implementation of this scheme is currently under investigation.

## REFERENCES

- [1] M. S. Bigelow, N. N. Lepeshkin, and R.W. Boyd, "Superluminal and slow light propagation in a room temperature solid," *Science*, 301, 200-202 (2003).
- [2] P. C. Ku, F. Sedgwick, C. J. Chang-Hasnain, P. Palinginis, T. Li, H. Wang, S. W. Chang and S. L. Chuang, "Slow light in semiconductor quantum wells," *Opt. Lett.* 29,2291-2293 (2004).
- [3] K. Y. Song, M. G. Herráez, and L. Thévenaz, "Observation of pulse delaying and advancement in optical fibers using stimulated Brillouin scattering," *Opt. Express*, 13, 82-88 (2005).
- [4] A. Y. Petrov and M. Eich, "Zero dispersion at small group velocities in photonic crystal waveguides," *Appl. Phys. Lett.* 85, 4866-4868 (2004).
- [5] L. V. Hau, S. E. Harris, Z. Dutton, and C. H. Behroozi, "Light speed reduction to 17 meters per second in an ultracold atomic gas," *Nature*, 397, 594-598 (1999).
- [6] Agrawal, G.P. *Nonlinear Fibre optics* 4th Edition.
- [7] V. Lucarini, K.E. Peiponen, J.J Saariinen, and E. M. Vartiainen, *Kramers-Kronig Relations in Optical materials Research* ( Springer Series in Optical Sciences), 1st ed. Berlin, Heidelberg, New York: Springer-Verlag, 2005.

# Strain Rate Effect on the Tensile Behavior of Fiber Bundles Isolated from Nerve Root

Atsutaka Tamura, Junji Murakami, Yuta Sone and Takao Koide

**Abstract**—Fresh porcine spinal cords ( $N = 5$ ) were obtained at a local abattoir, and intact nerve roots were excised at cervical, thoracic, and lumbar levels using a surgical scalpel and fine forceps with a special caution. In total, 77 fiber bundles with a dimension of 30 mm in length and 0.5 mm in diameter were isolated from the excised nerve roots. By conducting a series of uniaxial stretching tests at three different velocities, 0.1, 1, and 10 mm/s, we revealed that mechanical properties of fiber bundles were relatively insensitive to strain rates under such a sub-impulsive loading condition. On average, elastic moduli, linear portion of stress–strain curve, resulted in 3.8, 3.3, and 4.5 MPa for 0.1, 1, and 10 mm/s, respectively. In addition, strain at failure was almost constant,  $\sim 0.15$ , irrespective of a 100-fold increase in the applied loading rate, while at the same time axial strains were distributed non-homogeneously along fiber direction. We also found that spinal level effect may exist in the spinal nerve roots, suggesting that we should pay more close attention even to an anatomical site where excised samples are obtained.

**Keywords**—nerve root, fiber bundle, uniaxial stretch, whiplash injury, automotive crash.

## I. INTRODUCTION

WHIPLASH injury, one of the typical traffic injuries involved with automotive accidents, is a world-wide health concern. Since inflicted trauma of the nervous system is likely to cause a long-term impairment or permanent disability, whiplash injury may result in a deterioration of the patient's quality of life in addition to a high societal cost relevant to the medical treatment. However, a specific mechanism of whiplash or the source of pain associated with it is yet to be clarified. With regard to an anatomical structure, the spinal cord is directly or indirectly protected by the three-layered meninges and “cushion-like” cerebrospinal fluid filling the subarachnoid space, while it is physically supported by the nerve roots inside the spinal canal, i.e., a series of nerve roots locating along both sides of the spinal cord play an essential role in limiting its physiological ranges of motion in the spine. Thus, it would be possible that traumatic loading condition experienced in an automotive crash leads to a mechanical and functional damage of the nerve roots and results in whiplash-associated disorders. In recent years, it is common to utilize a mathematical human body model to predict blunt trauma involved with traffic accidents [1]–[3]. In terms of an injury prediction, it is critically

important to incorporate accurate mechanical properties into mathematical models to produce a “reasonable” and biofidelic response. But accurate characterization of nerve root, which provides important data for advanced numerical modeling, has not been adequately addressed. In the present study, we assumed that a mechanical stretch is applied to the nerve roots when an impulsive neck flexion/extension movement occurs during rear-end collision, resulting in an acute or chronic pain by exceeding some “critical” point. Hence, as a first step, this study aimed to measure the mechanical properties of the nerve roots by performing a uniaxial tensile test at elongation rates relevant to sub-impulsive loading condition.

## II. MATERIALS AND METHODS

### Sample preparation

Fresh porcine spinal cords ( $N = 5$ ) were procured at a local abattoir immediately after sacrifice and were carried back to the laboratory with ice packs. The intact nerve roots, locating along both sides of the spinal cord, were excised using a surgical scalpel and fine forceps at room temperature with a special caution and kept in a physiological saline to avoid dehydration. Further, nerve roots were stored in a refrigerator overnight (12 h) at 4°C in a 50% (v/v) glycerol physiological saline solution. Biological materials stored in this manner have been shown to have stable mechanical properties [4]–[6], and stored samples showed no signs of deterioration at the macroscopic scale in the current work. For dissection of fiber bundle samples, nerve roots were removed from the storage solution and transferred into a dish filled with the physiological saline. Single fiber bundles with a dimension of 30 mm in length and approximately 0.5 mm in diameter were carefully separated from the nerve root using fine forceps and a dissecting needle, and were subsequently kept in the physiological saline solution in the ice-cold box until the experiment.

### Mechanical testing

The isolated specimen was mounted on a custom-made test apparatus integrated with a pair of parallel-plate load cells (Fig. 1), which is capable of applying 40 mm stretch at a maximum rate of 20 mm/s. One strain gauge (UFLK-1-11, Tokyo Sokki Kenkyujo) was glued onto each side of the thin stainless steel plates (50 mm long  $\times$  10 mm wide  $\times$  0.1 mm thick) and the half-bridge circuit, i.e., the two active gauge method, was set up. The custom-made parallel-plate cantilever arms were then attached to a pair of linear motors (XMSG430, Suruga Seiki)

Atsutaka Tamura, Department of Mechanical and Aerospace Engineering, Graduate School of Engineering, Tottori University (phone: +81857316793; fax: +81857316793; e-mail: a-tamura@mech.tottori-u.ac.jp).

that controlled the specimen length with a controller driven in a half-step mode (MSTCL102, Suruga Seiki). These arms acted as sensitive force transducers, i.e., channels 1 and 2, and zero strain for performing data analysis was defined later as the point where the sum of the forces in channels 1 and 2 constantly exceeded 0.2 mN. Force data was recorded using a commercial data acquisition system (NR-ST04R, Keyence) at 1 kHz per channel.

An image of the fiber bundle was captured using a digital camera (EX-ZR400, Casio) from both top and side views with a mirror inclined at 45° angles to measure the specimen's length, width, and height; a movie was recorded at 30 fps during each test to produce consecutive still images for post-processing image analysis. To synchronize the timing of the captured image and force data, an LED light was brought into the field of observation view, and was manually turned on when we started testing. The driving voltage of the LED was also recorded in the data acquisition system (NR-HA08, Keyence) and used to match the timing of the turning-on of the LED in the video.

Additionally, both ends of the specimen were glued to the cantilever arm tips using cyanoacrylate adhesive and immersed into the warmed physiological saline. Each of the specimens was manipulated very carefully to avoid uncontrolled stretching and severe torsion. The innermost initial distance between the grips was adjusted to 18 mm while maintaining the suspended fiber bundle almost horizontally using micrometers attached to the linear motors such that the stretch was applied purely in the fiber axial direction. Vanilla beans were placed along the longitudinal axis of isolated fiber bundles at approximately 1-mm intervals and used as markers to monitor local strains (Fig. 2). Further, each specimen was divided into 10–12 segments, numbered from one to 10–12 along the axial fiber direction.

As shown in Figure 3, a typical loading path consisted of six cycles of preconditioning, 60-s rest, and a final stretch up to failure. In the preconditioning cycle, uniaxial stretch was applied to a fiber bundle at a rate of 1 mm/s until it reached approximately 10% strain (4-mm displacement). After a complete recovery of residual slack during the rest time, the final stretch was applied at either of the three different velocities, 0.1 mm/s (0.006 s<sup>-1</sup>), 1.0 mm/s (0.06 s<sup>-1</sup>), or 10 mm/s (0.6 s<sup>-1</sup>), so that local strains progressively increased until failure. Samples were discarded if any irregularities were observed along their length during testing or if they were damaged or if they slipped at either of the attachment points during the preconditioning cycle. At the end of an experiment, any fiber bundle that had distinct tears or disruptions at the attachment points was also rejected. Consequently, 36 of 77 specimens were rejected based on these criteria. The temperature of the specimen bath was maintained at 37°C with a hot plate (TP-SP, Tokai Hit). All the experiments were completed within 12 h after specimens were prepared.

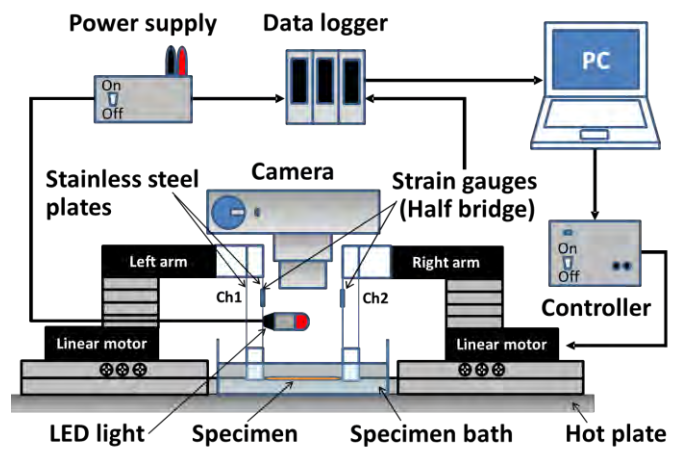

Fig. 1: Schematic view of a uniaxial tensile tester.

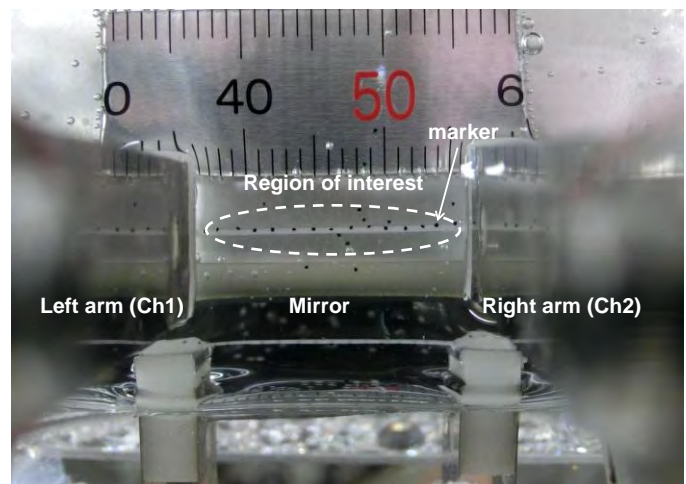

Fig. 2: Magnified region of interest subjected to a dynamic uniaxial stretch.

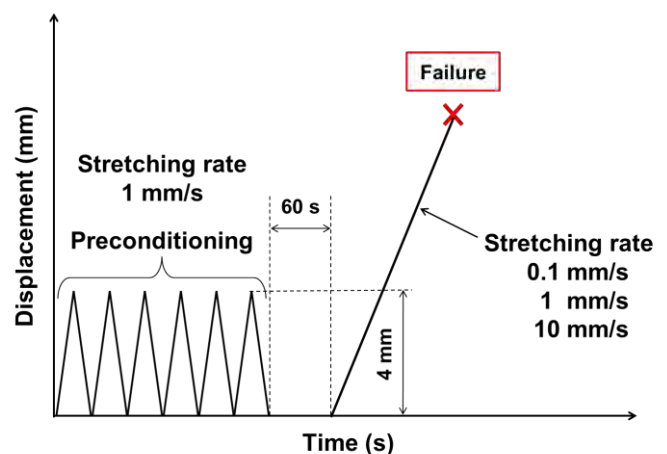

Fig. 3: Test protocol consisting of a set of preconditioning cycles, 60-s rest, and final stretch up to material failure.

### Data analysis

After the experiment, sample dimensions were measured with an image processing software (ImageJ, NIH). Stress was obtained as the force divided by the initial cross-sectional area, assuming a cylindrical shape of the specimen, and the fiber cross-sectional area was calculated as the mean of three individual measurements at the central region of the fiber bundle. Further, axial strain of each segment along the fiber bundle was obtained as the stretch ratio, the current length divided by the initial length stipulated between two adjacent markers; “strain” for depicting a stress–strain curve was then calculated as the mean value of a series of local axial strains obtained for each fiber bundle.

## III. RESULTS

### Axial strain distribution

A typical transient changes in axial strain up to failure obtained in a final stretch is shown in Figure 4. Even in a relatively low-rate loading condition at 1 mm/s ( $0.06 \text{ s}^{-1}$ ), the applied stretch was distributed non-uniformly along the fiber bundle, resulting in random disparity of axial strains among divided segments or strain concentration in a specific site. Some of the regions appeared to lengthen substantially just before failure, possibly due to the concentration of micro-damage caused by overstretching. However, averaged stretch at failure was almost constant irrespective of a 100-fold increase in the applied loading rate (Fig. 5); the specimens failed at stretch ratios of  $1.15 \pm 0.03$ ,  $1.13 \pm 0.02$ , and  $1.17 \pm 0.02$  (mean  $\pm$  SD) on average, for strain rates of 0.006, 0.06, and  $0.6 \text{ s}^{-1}$ , respectively, indicating that the fiber bundles were elongated almost uniformly from a macroscopic point of view and failed at a random site. Moreover, we found that averaged strains among divided segments were almost the same as that obtained from the length change between two markers placed at both ends, i.e., a measurement error fell within a range of 0.5% during the loading phase up to failure. Thus, in the following analysis, fiber strains were calculated based on the length change stipulated by both end markers.

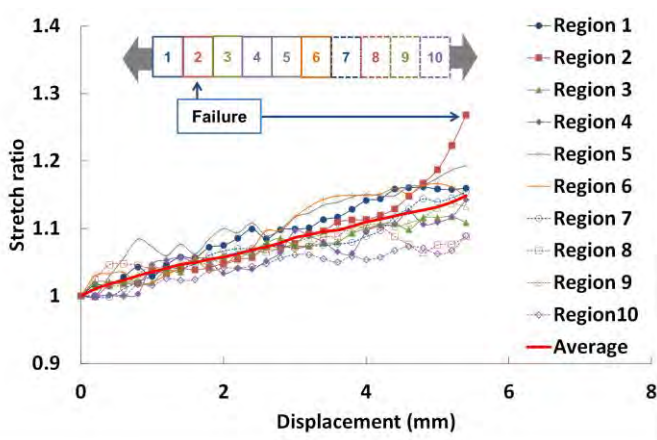
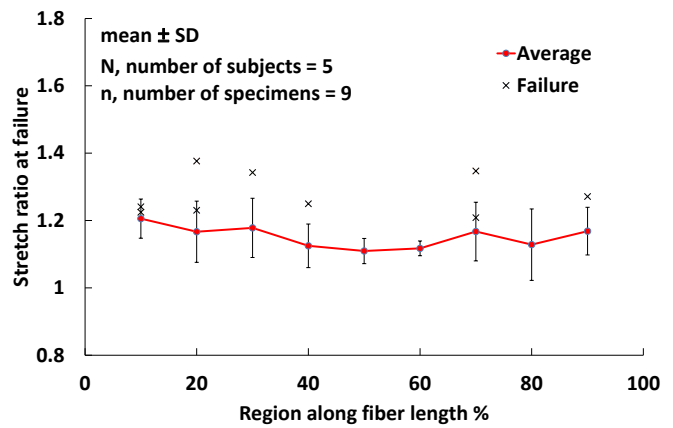
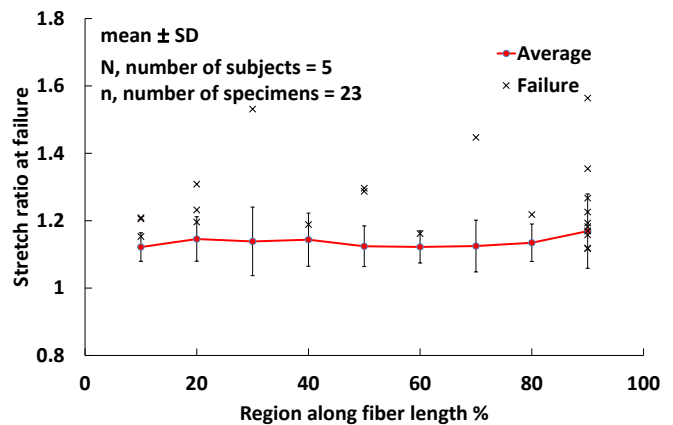

Fig. 4: Typical transient changes in axial stretch ratio among divided segments; each data was obtained from a fiber bundle isolated from lumbar spinal nerve root stretched at 1 mm/s.



(a) 0.1 mm/s ( $0.006 \text{ s}^{-1}$ ).



(b) 1 mm/s ( $0.06 \text{ s}^{-1}$ ).

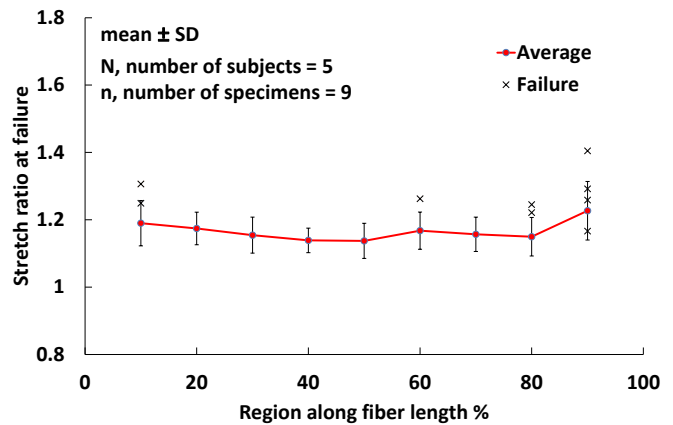

(c) 10 mm/s ( $0.6 \text{ s}^{-1}$ ).

Fig. 5: Stretch distribution along fiber length just before failure.

### Tensile behavior

Figure 6 demonstrates a series of stress–strain curves obtained at three different loading rates. As is common for biological soft tissues, a toe-region was observed early in the loading phase. As shown in Table 1, the tensile strength was significantly higher for specimens stretched at 10 mm/s ( $0.6 \text{ s}^{-1}$ ) compared to those stretched at the relatively moderate loading rates, 1 mm/s ( $0.06 \text{ s}^{-1}$ ) and  $0.1 \text{ mm/s}$  ( $0.006 \text{ s}^{-1}$ ). In addition, significant difference was observed for failure strain between the groups stretched at 1 and 10 mm/s. Furthermore, apparent elastic moduli for each of the test conditions were

calculated as shown in Table 2. To approximate the obtained stress–strain curve as a bilinear function, Young’s moduli  $E_1$  and  $E_2$  were defined for the toe region (0–5% strain) and the linear part ( $\epsilon > 5\%$  strain up to failure), respectively. The elastic moduli obtained at the moderate loading rates, 0.1 mm/s (0.006 s<sup>-1</sup>), 1 mm/s (0.06 s<sup>-1</sup>), and the high loading rate, 10 mm/s (0.6 s<sup>-1</sup>), were favorably comparable in low as well as high strain regions. However, the elastic moduli obtained for linear region,  $E_2$ , were significantly different between the groups stretched at 1 and 10 mm/s (Table 2).

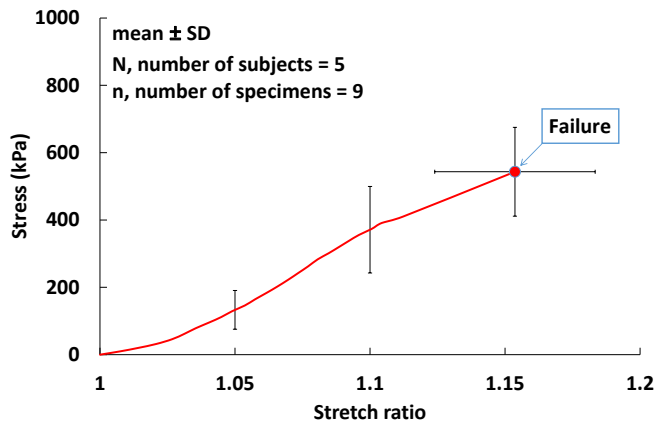

(a) 0.1 mm/s (0.006 s<sup>-1</sup>).

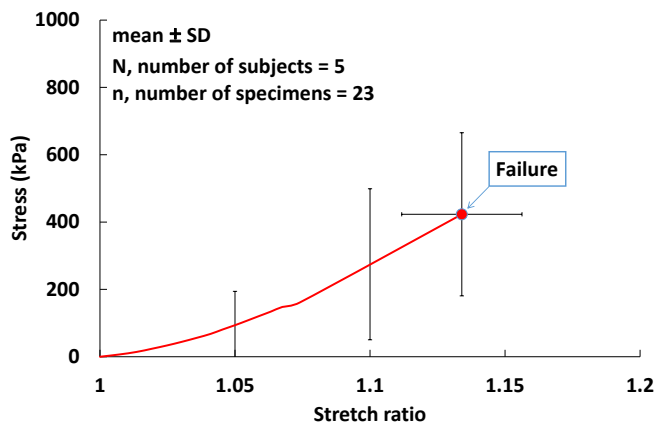

(b) 1 mm/s (0.06 s<sup>-1</sup>).

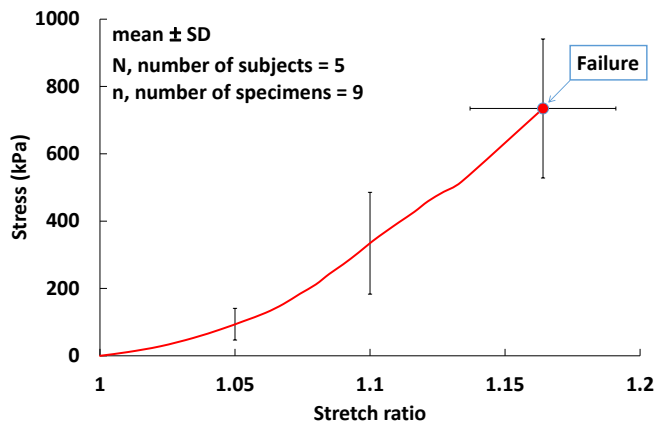

(c) 10 mm/s (0.6 s<sup>-1</sup>).

Fig. 6: Stress–stretch ratio curves obtained for a series of dynamic uniaxial stretching tests.

TABLE I  
TENSILE STRENGTH AND FAILURE STRETCH OBTAINED FOR THREE DIFFERENT LOADING RATES (MEAN ± SD).

Stretch rate (mm/s)	n (N = 5)	Tensile strength (kPa)	Failure stretch
0.1	9	543 ± 132	1.15 ± 0.03
1	23	430 ± 242	1.13 ± 0.02
10	9	713 ± 178	1.17 ± 0.02

Asterisks indicate a statistical significance, i.e., \* $P < 0.05$  and \*\* $P < 0.01$ .

TABLE II  
ELASTIC MODULI OF TOE AND LINEAR REGIONS OBTAINED FOR THREE DIFFERENT LOADING RATES (MEAN ± SD).

Stretch rate (mm/s)	n (N = 5)	$E_1$ (MPa)	$E_2$ (MPa)
0.1	9	2.95 ± 1.15	3.80 ± 1.07
1	23	2.34 ± 1.86	3.26 ± 2.03
10	9	2.06 ± 0.94	4.49 ± 1.07

Asterisks indicate a statistical significance, i.e., \* $P < 0.05$  and \*\* $P < 0.01$ .

### Spinal level effect

Out of the 41 fiber bundles isolated from spinal nerve roots, 23 specimens subjected to stretch at a rate of 1 mm/s ( $N = 4$ ) were selected and divided into three groups based on the anatomical sites or spinal levels where specimens were excised; mechanical properties of the nerve roots were then evaluated at cervical, thoracic, and lumbar levels (independent  $t$ -tests). As summarized in Table 3, stretch at failure was obviously independent of spinal levels. No significant differences were found between cervical and thoracic spinal levels in tensile strength and elastic moduli, either (Tables 3 and 4). On the other hand, tensile strength was significantly higher in cervicothoracic spinal levels as compared to lumbar spinal level ( $P < 0.01$ ). The elastic moduli were also found to be higher in cervicothoracic spinal levels as compared to lumbar spinal level.

TABLE III  
TENSILE STRENGTH AND FAILURE STRETCH OBTAINED FOR EACH OF SPINAL LEVELS AT THE STRETCHING RATE OF 1 MM/S (MEAN ± SD).

Spinal level	n (N = 4)	Tensile strength (kPa)	Failure stretch
Cervical	5	609 ± 145	1.15 ± 0.02
Thoracic	7	610 ± 169	1.13 ± 0.02
Lumbar	11	236 ± 168	1.13 ± 0.02

Asterisks indicate a statistical significance, i.e., \* $P < 0.05$  and \*\* $P < 0.01$ .

TABLE IV  
ELASTIC MODULI OF TOE AND LINEAR REGIONS OBTAINED FOR EACH OF SPINAL LEVELS AT THE STRETCHING RATE OF 1 MM/S (MEAN ± SD).

Spinal level	n (N = 4)	$E_1$ (MPa)	$E_2$ (MPa)
Cervical	5	2.61 ± 1.19	4.25 ± 1.07
Thoracic	7	4.03 ± 2.27	4.80 ± 2.02
Lumbar	11	1.15 ± 0.61	1.83 ± 1.34

Asterisks indicate a statistical significance, i.e., \* $P < 0.05$  and \*\* $P < 0.01$ .

#### IV. DISCUSSION

The accurate mechanical characterization of biological soft tissues is critically important to well predict traumatic injuries using a computational model. However, available data obtained at high loading rates is considerably limited due to the technical difficulties involved in handling the soft tissue materials. In the present study, we performed a series of uniaxial stretching tests using fiber bundles isolated from porcine nerve roots. We investigated mechanical properties of fiber bundles by applying the sub-impulsive loading rates ranging from 0.1 to 10 mm/s; typical stress-strain curves of biological soft tissues with a toe region followed by a linear region were obtained (Fig. 6), which can be simply approximated by a bilinear function. As we expected, a statistical significance ( $P < 0.01$ ) was found in tensile strength between the high (10 mm/s) and moderate loading rates (0.1 and 1 mm/s). But contrary to our expectation, neither the elastic moduli, nor the stretch at failure were strongly sensitive to tensile velocities given here (Tables 1 and 2), although there was a 100-fold increase in the applied loading rate, i.e., nerve roots are inherently insensitive to stretching velocity under sub-impulsive loading rates. It should be noted, however, that the tensile strength was significantly different between cervicothoracic and lumbar spinal levels at the rate of 1 mm/s (Table 3), suggesting that there is some spinal level effect in the mechanical strength of nerve roots. This might be reasonable when an anatomical structure of the spinal cord is considered, i.e., since the spinal cord is directly connected to the brain, the heaviest organ in the central nervous system, it is more likely that nerve roots of the cervicothoracic levels are constantly exposed to mechanical stretch due to a daily motion or activity rather than those of the lumbar spinal level.

Singh et al. [7] evaluated biomechanical properties of rat dorsal nerve roots at the lumbar and sacral levels using two different stretching rates,  $0.000833 \text{ s}^{-1}$  (0.01 mm/s) and  $1.25 \text{ s}^{-1}$  (15 mm/s). With regard to maximum stress and elastic modulus of linear portion in stress-strain curve, they revealed that higher values occurred at the dynamic loading rate as compared to those at quasi-static loading rate, indicating that strain rate dependency exists in the spinal nerve roots. In more specific, dorsal nerve roots subjected to a mechanical stretch resulted in a maximum stress of  $258 \pm 111 \text{ kPa}$  and elastic modulus of  $1.3 \pm 0.8 \text{ MPa}$  for 0.01 mm/s and  $625 \pm 307 \text{ kPa}$  and  $2.9 \pm 1.5 \text{ MPa}$  for 15 mm/s, respectively. Significant differences in mechanical behavior were also observed among the four root levels (L4, 5, 6 and S1) where each of the specimens were isolated. However, no statistical difference was found in the strain values at failure even though there was a 1500-fold increase in the applied loading rate. Similar to their work, in the present study, an averaged regional stretch distribution along axial fiber direction that we obtained was almost consistent just prior to failure (Fig. 5), although axial strains were distributed

non-uniformly along the fiber length even in the moderate loading rate, 1 mm/s (Fig. 4); these results may indicate that fiber bundle fails at the point when an applied stretch reached some “critical” strain.

This study is limited by a couple of reasons. In the current work, testing samples were stored in 50% (v/v) glycerol saline solution for overnight before fiber bundles were isolated from the excised nerve roots. According to the previous studies [4]–[6], glycerol effect on mechanical properties of biological specimens is relatively limited in case the immersion time is well controlled. For instance, van Noort et al. [4] reported that no statistically significant difference was shown in mechanical properties of human dura mater irrespective of time of storage in 98% (v/v) glycerol for 1–12 days. McGarvey et al. [5] also reached a similar conclusion, i.e., storage in 98% (v/v) glycerol for more than two weeks shifted the stress-strain curve to lower strain, however, the mechanical effect of glycerol preservation on human dura mater was not significant for elastic modulus calculated from the linear portion of the stress-strain curve. In addition, Hashimoto et al. [6] characterized compressive properties of porcine cornea and showed that elastic moduli of the cornea were not significantly different between before and after 100% (w/w) glycerol immersion treatment for 1 h. Since glycerol acts as a weak dehydrating agent, long-term glycerol storage is likely to stiffen mechanical responses of biological materials. However, the testing samples we used were immersed in 50% (v/v) glycerol solution for only 12 h, and the mechanical effect of glycerol storage was resultantly minimized as much as possible. In fact, we did not find any specific damage in the specimens by visual inspection; there might be some microscopic damage existed in the tested samples, though.

Another limitation is a protocol for preconditioning. With regard to a set of preconditioning cycles, Cheng et al. [8] suggested that mechanical responses of biological materials were significantly affected by its procedure, e.g., magnitude of applied strain or strain rate or the number of cycles, etc. We adopted six cycles of a 4-mm displacement, which corresponds to ~10% strain of initial reference length or ~70% of failure strain, for preconditioning each of the specimens before conducting an actual test to failure. The preconditioning cycle was given at 1 mm/s irrespective of the loading rate for the subsequent actual tests. Since it is uncertain whether or not the preconditioning procedure that we had implemented was an optimal option, further study will be required in the future.

#### V. CONCLUSION

A series of uniaxial tensile tests were conducted with the use of fiber bundles isolated from nerve roots at quasi-static (0.1 mm/s), medium (1 mm/s), and high (10 mm/s) loading rates. We found that strain rate effect was relatively insignificant for mechanical parameters related to tensile behavior, i.e., tensile strength, elastic modulus, and failure strain were almost constant irrespective of a 100-fold increase in the applied stretching rate. Our results also suggested that spinal level

effects were of significance in tensile strength and elastic modulus between the specimens obtained at cervicothoracic and lumbar spinal levels. The mechanical data obtained here will be useful to improve a human head-neck complex model and assess the mechanical response as well as the potential for injury by performing a rear-end impact crash simulation.

#### ACKNOWLEDGEMENT

This study was partly supported by a special research grant provided by the president at Tottori University.

#### REFERENCES

- [1] J. Hasegawa and A. Shiomi, "A study of whiplash injury occurrence mechanisms using human finite element model." In: Proceedings of 18th International Technical Conference on the Enhanced Safety of Vehicles, Paper #195, 2003, Nagoya (Japan).
- [2] D.S. Cronin, "Finite element modeling of potential cervical spine pain sources in neutral position low speed rear impact," *J. Mech. Behav. Biomed. Mater.*, vol. 33, 2014, pp. 55–66.
- [3] A. Tamura, T. Koide, and K.H. Yang, "Effects of ground impact on traumatic brain injury in a fender vault pedestrian crash," *Int. J. Vehicle Safety*, vol. 8, 2015, pp. 85–100.
- [4] R. van Noort, M. M. Black, T. R. P. Martin, and S. Meaney, "A study of the uniaxial mechanical properties of human dura mater preserved in glycerol," *Biomaterials*, vol. 2, 1981, pp. 41–45.
- [5] K. A. McGarvey, J. M. Lee, and D. R. Boughner, "Mechanical suitability of glycerol-preserved human dura mater for construction of prosthetic cardiac valves," *Biomaterials*, vol. 5, 1989, pp. 109–117.
- [6] Y. Hashimoto, S. Funamoto, S. Sasaki, T. Honda, S. Hattori, K. Nam, T. Kimura, M. Mochizuki, T. Fujisato, H. Kobayashi, and A. Kishida, "Preparation and characterization of decellularized cornea using high-hydrostatic pressurization for corneal tissue engineering," *Biomaterials*, vol. 31, 2010, pp. 3941–3948.
- [7] A. Singh, Y. Lu, C. Chen, and J. M. Cavanaugh, "Mechanical properties of spinal nerve roots subjected to tension at different strain rates," *J. Biomech.*, vol. 39, 2006, pp. 1669–1676.
- [8] S. Cheng, E.C. Clarke, and L.E. Bilston, "The effects of preconditioning strain on measured tissue properties," *J. Biomech.*, vol. 42, 2009, pp. 1360–1362.



# Assessment of Environmental Challenges Posed by Ponds in Katsina City, Northern Nigeria

Suleiman Iguda Ladan

**Abstract**--Most ancient cities in developing countries are facing serious environmental challenges as the number of their inhabitants increase due to population growth and migration. Katsina city one of the oldest cities in Nigeria faces serious environmental challenges that arise from the numerous ponds within the city wall. This paper is based on empirical research that involved reconnaissance surveys, field visits to assess the challenges and interview with people whose houses and businesses are located close to the ponds. The results of the data collected and analyzed have shown that the ponds were old areas where laterite, clay and gravel were excavated for building mud houses at that time. The excavations created depressions or hollows that rain water and sewage flow into forming water ponds. Some of the ponds have become silted and contain no water while others contain water. The pond presently serve places for sewage disposal, waste dumps, public toilets, laterite and clay excavation sites, hide outs for drug addicts and criminals. The challenges posed by the ponds include breeding ground for vectors of diseases, destroying beauty of the surroundings, contributing to urban flooding, water and air pollution among others. Several attempts to overcome these challenges by wealthy individuals, committee of residents and the State Environmental Protection Agency include filling some of the ponds, draining the water away, fencing of the pond area to reduce waste disposal, building of underground drainages to avert urban flooding. However these efforts have not fully overcome the challenges as they still persist in many areas of the city. It is therefore recommended that environmental engineering principles should be applied to overcome the challenges once and for all.

**Key words:** Assessment, Environmental challenges, Katsina city, Ponds

## I. INTRODUCTION

Most ancient cities in developing countries are facing serious challenges as the number of their inhabitants' increases due to population growth and migration. Some of these challenges arise as a result of water bodies such as rivers, streams, lakes and ponds that flow through or are found in the cities. In Nigeria there are several cities that have rivers, streams, lakes and ponds flowing through or are found in the cities which directly posed environmental challenges to the inhabitants. These challenges include becoming breeding ground for disease vectors, risk of drowning, waste disposal in the water bodies, underground water pollution, and risk of flooding residential areas.

One of the water bodies in cities in Nigeria particularly those in the northern part are ponds. Ponds are small bodies of still water formed naturally by hollowing or embanking. Ponds are bodies of standing water that occur naturally or artificially which are smaller than lakes [1]. A pond can be visualized as an artificial and sometimes natural water reservoir that develops around human settlements or around streams or river basins. It resembles a dam only that it does not necessarily exist along a river course (tributaries or distributaries). In most instances, a pond emerges whenever men dig the ground for the purpose of obtaining earth, mud or clay for building houses. The resulting pit burrow becomes a pond which usually traps large amount of rain water and/or sewage coming from the neighboring settlements [2].

It is based on the above instance that ponds have evolved in different parts of Katsina city particularly within the city wall. These ponds are found also in other ancient cities in northern Nigeria such as Kano, Sokoto, Zaria and Bauchi. Several studies were conducted on ponds in northern Nigeria and other parts of the developing countries. A study conducted in Kano examines the public health implications of sewage ponds in Kano metropolis, Nigeria [2]. In other parts of the developing world, a study was conducted on assessment of pond effluent effect on water quality of Asuafia stream in Nkawie, the capital of Atwima-Nwabiagya district in the Asanti Region of Ghana [3]. Another study is on phytoplankton study of Thalmand pond with special reference to their seasonal variation in Jodhur, Rajasthan India [4].

The present study aims at assessing the environmental challenges posed by ponds in Katsina city, northern Nigeria. The objectives of the study are to:

- (i) Examine the condition and uses of the ponds in Katsina city.
- (ii) Examine the environmental challenges posed by the ponds.
- (iii) Assess the efforts towards overcoming the challenges posed by the ponds.
- (iv) Suggest appropriate recommendations towards overcoming the challenges.

## II. THE STUDY AREA

The study area is Katsina city located at the extreme northern margin of Nigeria which lies between latitudes 13°00N – 13°25'N and longitude 7°37' and 8°00E. Katsina city has been built on a spur of land between Ginzo and Tilla streams which

---

Suleiman Iguda Ladan, Department of Basic and Applied Sciences Hassan Usman Katsina Polytechnic, Katsina Nigeria. (+2348169805626 e-mail:suleimaniguda@yahoo.com)

flow in a north easterly direction and is at narrow neck of watershed between the Gada and Tagwai river basins [5]. Katsina city is the headquarters of Katsina Local Government Area created in 1976 and the capital of Katsina State that was created in 1987, one of the 36 states that comprise the Federal Republic of Nigeria. Katsina is situated 170 kilometers north west of commercial city of Kano and 336 kilometers east of the city of Sokoto. This can be seen on Figure 1 below.



Fig.1: Map of Nigeria showing Katsina city

Katsina is an ancient city founded by Kumayo, the grandson of Bayajidda in 1100AD as a city state that has a 22 kilometers wall that surrounds it with entrance through eight city gates. The city became the main trans-Saharan caravan center of the Hausa states from the late 16<sup>th</sup> to 18<sup>th</sup> century. Katsina was also an important center for learning with renowned scholars such as Danmasani, Danmarna and Dantakum. In the late 18<sup>th</sup> century Katsina was annexed into the Sokoto caliphate during the jihad of Usman Danfodiyo. Katsina was conquered by the British colonialists in 1903 [6]. In terms of physical setting, the city is on the high plains of Hausaland on a spur of land between two streams of Tilla and Ginzo (See Figure 2). The city is located on an altitude of 464 meters or 1,525 feet above sea level. The drainage consists of these two streams almost encircling the city. There are also numerous ponds within the city wall many of which contain water even during the long dry season and fadama or flooded areas are found along the two streams. The climate is Tropical Continental Climate classified as AW tropical wet and dry climate based on Koppen's Climatic Classification with a mean annual temperature of about 27°C [7]. The annual rainfall average is about 780mm with most of the rains falling from May to August. The vegetation is Sudan savanna type with short scattered trees and grasses. However, most of the

vegetation is modified by human activities such as fuel wood exploitation, grazing and urbanization. The population of Katsina city has been observed to be increasing to over half a million people as a result of migration of people from the troubled north eastern Nigeria due to insecurity [8].

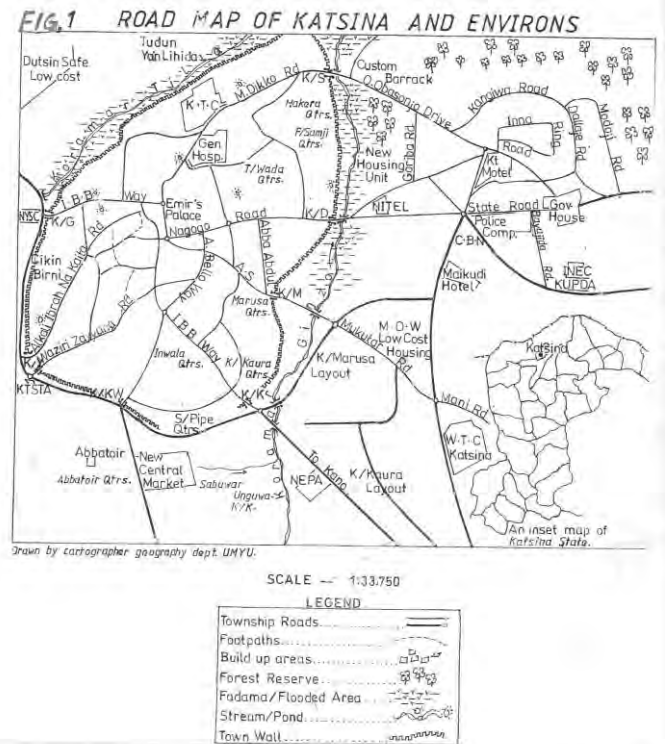

Fig. 2: Road map of study area

### III. RESEARCH METHODOLOGY

The research methods used to generate data include reconnaissance survey that were used to obtaining visual information about the geographic characteristics of the ponds in the city. This was followed by full scale field work that involved visits to the ponds that were sampled for the study in the month of March 2015 which is dry season period. The ponds sampled were those that either visibly contains water or clearly show signs that the ponds are not dry like presence of green grasses or other forms of aquatic vegetation. A total of fifteen (15) ponds were thus purposively sampled for the study out of an estimated thirty-five (35). Observations were made on the location, characteristics and human activities on the ponds sites to determine the uses of the ponds. People who are living in the residential quarters around the ponds were interviewed. The interview questions were on what challenges the ponds do posed to them, the efforts they are making to overcome the challenges and what appropriate recommendations would they suggest towards overcoming the challenges. Besides the interview, pictures of the ponds were snapped and included in the study to provide visual evidences of the existence and challenges posed by the ponds. The students of Al-Qalam University Katsina who are offering the course unit 'Disaster Management' were used as research

assistants. The use of research assistants to collect data for the study is to obtain more data needed for the research.

The limitations of the study are lack of data on the size of the ponds, their water holding capacity and not being able to get access to few ponds due to walls built to cover the pond sites. Also movements around the ponds sites are difficult and risky due to the filthy nature of the pond sites.

Secondary sources of data were collected through desk research and used in writing the paper. The secondary sources include published journal articles, textbooks, internet sourced materials and conference papers. The data collected were analyzed using descriptive analysis in terms of tabulations, percentages, averages and means.

#### IV. RESULTS AND DISCUSSIONS

Katsina city is an ancient settlement founded in 1100AD. Homes, businesses, public building and the city wall built for defense evolved from building materials that were directly obtained from the land. People in different parts of the city dig the ground to collect materials that they use for building. The result is that continuous digging to collect building materials produce hollows or depressions where rain water collect as ponds. Therefore the ponds that are found in different parts of the city are old areas where the laterites, clay and gravel were excavated for building mud houses at that time. The excavations created depressions or hollows that rain water and sewage flow into forming ponds. According to some of the elderly people that reside in areas close to the ponds, many of the ponds are over one hundred years old today. However, as time goes on some were filled and built up while others became silted and thus do not contain water as there is no depression for rain water to collect in. This research study sampled those ponds that contain water or show clear evidence that the ponds are not dry.

##### *A. The condition and uses of the ponds in Katsina city*

The sampled ponds were in different condition during field visit and serve different uses by the residents of the areas they are located. These can be seen on the table 1 below.

**Table I: The Condition and Uses of the Ponds in Katsina city**

S/N	Name and location of pond	Condition of the pond	Uses of the pond
1	Babban Rami pond at 'Yansiliyu quarters	- Part of pond contains water. - Part of the pond is silted	- Used as refuse dump - Site for composting of waste
2	Bara zaki pond at Gambarawa quarters	- Part of the pond contains water with green grasses. - Part of the pond is silted.	- Waste disposal site - Place for open defecation
3	Giwar Raka pond at Masanawa quarters	- Pond contain water with vegetation covering the top	- Used as refuse dump - Fencing of pond restrict usage
4	Kamitawa pond at	- Large part of the pond contains	- Waste disposal site - Place for open

	Rafindadi quarters	-	waster Typher and materials are found on the pond	-	defecation Sewage disposal
5	Maliyau pond at Kofar Guga quarters	-	The whole of the pond contain water	-	Used for swimming by children.
		-	Water is muddy with no sewage in it	-	Fishing activity on the pond
6	Ramin Masu pond at Gafai quarters	-	Pond contains water in a depression.	-	Used as refuse dump
		-	Green grasses covers the top of the pond	-	Used for sewage disposal and open defecation
8	Tafkin Gwangwan at Gwangwan quarters	-	Pond has water covered by water hyacinth.	-	Used as refuse dump
		-	Pond has no outlet to drain excess water.	-	Used for sewage disposal
9	Tafkin Kofar Bai at Kofar Bai quarters.	-	Only a small section of the pond has water.	-	Used as refuse dump
		-	Large part is dry	-	Used for sewage disposal
10	Tafkin Lemu at Darma quarters	-	Part of pond contains water.	-	Used for sewage disposal and refuse dump
		-	Part of pond covered by green grasses	-	Cutting of grasses for livestock feeding.
11	Tafkin Rakati at Kofar Bai quarters	-	Shallow pond covered by green grasses.	-	Used for refuse disposal
		-	Pond has largely become silted	-	Domestic animals graze on the grasses
12	Tafkin Tsakar Unguwa at Rafukka quarters	-	Pond contains water.	-	Refuse disposal site for the residents.
		-	Part of pond covered by water hyacinth	-	Sewage disposal pond
13	Tafkin Unguwar Sharriffai	-	Pond contain water mostly	-	Refuse disposal site
		-	No any form of vegetation on the pond	-	Sewage disposal pond
14	Tafkin Yammawa at Yammawa quarters	-	Part of pond contain water	-	Refuse disposal site
		-	Part of pond has become silted	-	Sewage disposal site
		-		-	Animals grazing area
15	Zazzagau pond at Marnar Kadabo quarters	-	Part of pond contain water	-	Refuse disposal site
		-	Green grasses covers pond	-	Sewage disposal sites

Source: Field work 2015

From the table it can be observed that the ponds have different names. Some of the names describe the characteristics of the pond in the local Hausa language e.g Babban Rami pond mean big depression pond. Other names are based on the neighbourhood in which they are located e.g Tafkin (pond) Kofar bai, Tafkin Yammawa and Tafkin Unguwar Sharriffai. In terms of condition of the ponds, all the ponds (100%) contain water or evidence that there is water in the ponds. Twelve of the ponds (86.6%) are covered by vegetation which

includes hyacinth, typher grasses, bird's millets etc. Ten of the ponds (66.6%) have parts that are silted which reduce their sizes. Only two of the ponds (13.3%) have been covered with walls which restrict access to them by the people. These ponds are Giwar Raka and Zazzagau ponds located in densely populated residential areas of Masanawa and Marnar kadabo. The ponds are used for various purposes depending on the location and condition of the pond. Fifteen of the ponds (100%) are used for waste disposal that is as refuse dump. This arises due to inadequate waste disposal centers in the city which led to the use of the ponds as refuse dumps. A study conducted in 2013 indicates that 13% of the city's residents dump their refuse in water ponds [10]. Twelve of the ponds (86.6%) are used as sewage disposal sites which arise as there is no centralized sewage disposal system in the city. A study on the sewage disposal methods conducted in 2013 indicates that 17% of residential areas discharge their sewage into ponds [11]. Eight of the ponds (53.3%) are used for open defecation by children, beggars (*Almajirai*) and other people who do not have decent toilet facilities. These groups of people use the ponds as toilets at all times of the day. During field visit to Bara Zaki pond and Tafkin Lemu five children were seen defecating openly beside the ponds. Six of the ponds (40%) are used for grazing as domestic animals such as goats were seen consuming the vegetation that grows at the edges of some ponds such as Bara Zaki and Tafkin Rakati. In other ponds children and men were seen cutting grasses that will be used for grazing of livestock. Examples of these ponds include Tafkin Lemu and Kamitawa pond. In one of the ponds (15%) children were seen swimming as at the time of field visit and also lines of hooks were seen erected in this pond which is an indication of fishing activity there. Interview with some residents have revealed that there are criminals and drug addicts in the city that use the pond sites as their hideouts particularly at night. The figures 3 and 4 below show refuse dumping and sewage disposal in two of the ponds.



Fig. 3: Refuse dump around Babban Rami Pond Yansiliyu Quarters



Fig. 4: Sewage water at Tafkin Unguwar Sharriffai quarters.

#### B. Environmental challenges posed by the ponds

The ponds sampled for the research study pose serious environmental challenges to the inhabitants of the city particularly those residential areas where these ponds are found. These challenges are highlighted below.

The pond pose a serious threat to the safety of lives of the people. This threat exists as people swim in the ponds or accidentally fell into the ponds particularly during the rainy season when the ponds are full with water. In 2012, two pupils of Gidado primary school drowned and died while swimming in Tafkin Tsakar Unguwa at Rafukka quarters. In 2013, two young girls accidentally fall into Baban Rami Pond at Yansiliyu quarters and were later found dead. In the same year (2013), three boys were found dead as they were swimming in Ramin Masu pond at Gafai quarters. In 2014, one man drowned and died at Tafkin Mailyau at Kofar Guga based on information collected from the residents of the area.

Stagnant water in the ponds either rain water or sewage water is the breeding grounds of most vectors of diseases that affect the people in the city. A study conducted on Katsina has observed that improper sewage disposal in the ponds is responsible for causing diseases such as malaria, typhoid fever, diarrhea and dysentery [12]. The pond sites also serve as breeding ground for other disease vectors like snails for *schistosomiasis* (Bilharzias) and *fasciola hepatitis* in sheep and cattle, filarial worms for anemia and yellow fever in humans. Pathogenic microbes such as entero-bacteria, fungi, protozoa and viruses are also transmitted when people come in contact with the pond water [2].

Waste materials dumped in the ponds and around the ponds destroy the beauty of the surroundings. The waste materials dumped are not usually evacuated for disposal by the State Environmental Agency (SEPA), the result is that heaps of wastes accumulates around the ponds or even inside the ponds. The residents sometimes burn the waste materials that have accumulated to reduce the volume which causes air pollution and blacken the surroundings walls. The waste materials dumped in the pond sites have also become the hiding place for mosquitoes, rats, rodents and other vectors of diseases.



Fig. 5: Waste materials destroying beauty of surroundings at Tafkin Tsakar Unguwa Rafukka quarters.

The ponds have become sources of pollution of underground water particularly the walls that are found in homes that are close to these ponds. The pond water which is usually polluted (due to household refuse and sewage disposed in the ponds) through seepage some meters below the ground flow into the wells which pollutes the well water. A study conducted on the pollution of wells close to the ponds indicates extensive additions of dissolved salts and other contaminants in the water resulting in an intriguing fall in the quality of the well water [13].

The ponds contribute to the problem of urban flooding experienced annually in the city. The ponds for many years serve the function of storing rain water that flow from the surroundings. However, the situation today is that most of the ponds have become silted which reduces the amount of flood water they can contain and hence some of the flood water had to flow out of the ponds into people's houses destroying properties. Furthermore part of some of the ponds have been filled and the reclaimed land used for building of houses. This limits the amount of flood water the ponds can contain particularly during heavy rains. The result is that the ponds are easily filled with flood water with most of the water flowing directly into people's houses. This is the case in houses located close to Giwar Raka pond at Masanawa where some of the peoples have to leave their houses for sometime till the flood water recedes.

The ponds also contribute to the collapse of walls of houses that are very close to them. This usually happens during the rainy season when the ponds are full and the water periodically attack the base of the walls which after sometimes collapses. The ward head of Masanawa quarters during field visit to Giwar Raka pond counted eight houses whose walls have collapsed due to water from the ponds. At Tafkin Tsakar Unguwa and Ramin Masu pond at Gafai many walls very close to the ponds have collapsed with the owners unable to rebuild them.



Fig. 6: Collapsed walls of houses close to Ramin Masu pond at Gafai quarters.

The ponds lead to air pollution which affects people who live close to the ponds and people who pass on paths and roads close to the ponds. The air pollution originates from the waste materials that are dumped at the ponds sites which decompose under high temperature and the waste materials that were burnt to reduce the volume of the waste materials. Additional air pollution comes from the fecal matter that was deposited due to open defecation in spaces around the ponds. Human waste, if not properly managed affects the air through the odour, harbor insects such as flies to transmit diseases such as cholera [14]. The open defecation on spaces around the ponds also affects the aesthetics of the surrounding spaces.

The ponds and its surroundings have become hideouts for criminals and drug addicts particularly during the dry season when the pond water has receded leaving behind caves and corners that are used as hideouts. According to residents of Yansiliyu and Gambarawa quarters observed that the criminals have made the ponds their station particularly at night. They smoke Indian hemp and enter houses around the ponds to steal properties of occupants.

### *C. Efforts Towards Overcoming the Challenges Posed by the Ponds*

The ponds in Katsina city posed serious environmental challenges to the people in view of the negative impacts the ponds have created which affect their lives and properties. It is based on this that the State Environmental Protection Agency (SEPA), wealthy individuals, committee of residents, Katsina local government council and concerned individuals such as Environmentalists are making attempts to overcome these challenges towards improving the lives of the people. These are highlighted below:

- i) SEPA since its inception used to carry out ponds dewatering which is the removal of excess water from ponds in densely settled areas residential areas which have no outlet to drain excess water. The agency uses machines to remove the excess water, which ensures the excess water does not flow into houses or streets and also allow sewage to drain into the ponds [15]. Pond dewatering by the agency is an important measure against

- urban flooding as Katsina city has many ponds. In the years 2014, the ponds involved Babban Rami, at Yansiliyu Quarters, Bara Zaki at Gambarawa quarters, Ramin Masu at Gafai quarters and Zazzagau at Marnar Kadabo.
- ii) Katsina Local Government Area Council has been assisting residents who came to complain of ponds that could not drain excess water particularly during the rainy season. The Area Council using its staff supply machines to pump out excess water that could have diverted its flow into people's houses and streets. According to SEPA officials the assistance from the Area Council have reduced the number of ponds the Agency have to dewater in the recent years from 2010 – 2014. Examples of the ponds include Tafkin Gwangwan at Gwangwan quarters, Tafkin Rakati at Kofar Bai quarters etc.
  - iii) Committee of residents particularly on environmental sanitation days that fall on the last Saturday of every month do carry out activities aimed at reducing the challenges posed by the ponds. The committee of residents at Unguwar Sharriffai used to engage in collecting and evacuating waste materials that have choked the pond in their residential area and draining the water away into Kamitawa pond at Rafindadi quarters.
  - iv) Wealthy and influential individuals whose personal houses or family houses are located in front of the ponds have recently started to build wall of cement blocks that cover the ponds with only an entrance through a door. According to a resident of one of the residential areas the wall fencing is in order to reduce waste disposal, stop open defecation and block access of the pond area to criminals and drug addicts. Examples of such ponds include Giwar Raka pond at Masanawa and Zazzagau pond at Marinar Kadabo quarters.
  - v) In residential areas where the ponds are located in front of people's houses, there is the building of walls to block accidental falling of people into the trench of the ponds. This has been observed at Rafukka quarters where the pond is located at the middle of the residential quarters. This is also observed in front of a house located in front of Kamitawa pond at Rafindadi quarters.
- iii) The State Government should as a matter of urgency build Refuse Collection Centres (RCCs) in all the areas where these ponds are located to serve as refuse disposal centers rather than the ponds. People should be enlightened on the need to dispose refuse in these centers rather than the ponds.
  - iv) The State Government should assist the people to build drainages for sewage disposal that does not lead to the pond as a means of stopping the disposal of sewages in the ponds. In addition to this, there should be the rebuilding and expansion of existing drainages so that they carry or take away flood water from the ponds to avert the overflowing of pond water into residential buildings.
  - v) There is the need for the Government to carry out surveys and in-depth study into the flood problems of some ponds with a view to constructing underground drainages (similar to the one constructed for Kamitawa pond) to take away excess rain water out of the city. Also where it can be easily done, some selected ponds should be filled to reclaim the land that can be used for construction of public building like schools, clinics or community centres.
  - vi) There should be improvement in terms of security personnel who should be drafted to regularly patrol the pond sites that are used by criminals. Also there should be the formation of residential area based vigilante groups that will be involved in patrol at night time to dislodge the criminals and drug addicts from the pond sites.
  - vii) The Government should provide more public convenience facilities in form of toilets around all the ponds with a view to stop people from using the pond sites as public toilets. The public conveniences can also be constructed near the house of Islamic scholars where there is large number of pupils so that they desist from using the pond sites for open defecation.

#### IV.RECOMMENDATIONS

The following recommendations were offered towards overcoming the challenges posed by the ponds in Katsina city.

- i) The State Government should install sign posts at strategic locations around dangerous ponds that have recently claimed lives such as Babban Rami, Ramin Masu and Maliyau ponds to warn people of the impending hazards associated with swimming or even loitering near these ponds. This can deter some people from entering the ponds.
- ii) SEPA should on monthly basis carry out fumigation exercise on all the ponds to check the menace of mosquitoes and other harmful insects that are breeding in the stagnant water of the ponds.

#### V.CONCLUSION

The ponds of Katsina city originated out of necessity to excavate the land for building materials at that time when the population of the city was sparse and the ponds were far away from the people. Today, the situation has completely changed as the population grows rapidly and the ponds are found within residential buildings. The ponds pose serious environmental challenges to the people of the city as can be clearly observed based on the result and discussion of this paper. The State and Local Governments have now focused attention on these ponds and the challenges they pose in overcoming them. Based on what was observed during field visit to the ponds, the challenges are serious and the residents or wealthy individuals can in no way overcome the challenges. It is therefore recommended that the governments should directly step in to apply environmental engineering principles to overcome the challenges once and for all.

REFERENCES

- [1] R. M. Lodha *Academics Dictionary of Geography Academic( India) Publishers New Delhi India 2007* pp.312
- [2] M.D. Mukhtar, I. I. Indabawa and T. S. Imam “Public Health Implications of Sewage Ponds in Kano metropolis, Nigeria” *Journal of Food Agriculture and Environment* Vol. 8, No. 2, 2010 pp. 25-31
- [3] D. Amankwaah, S. J. Cobbina, Y. A. Tiwaa, N. Bakobie and E. A. B. Millicient’ “Assessment of Pond Effluent Effect on Water Quality of Asuofia stream, Ghana” *African Journal of Environmental Science and Technology* Vol. 8, No. 5 2014 pp. 306-311.
- [4] L. Meena, B. L. Kuldeep, P. Nama and M. R. Tandale “Phytoplankton Study of Jhalamand Pond with Special Reference to their Seasonal Variation” *Journal of Global Bioscience* Vol. 3, No. 6. 2014 pp 951-953
- [5] Maxlock Group *Katsina City Survey and Development Plans* Warminster Press England pp.2
- [6] *Encyclopedia Britannica Katsina Nigeria 2015* Available: [www.britannica.com/EBchecked/topic/313326/katsina](http://www.britannica.com/EBchecked/topic/313326/katsina)
- [7] S. I. Ladan “Climate Change and Extreme Weather Events: Case Study of Hailstorm in Katsina Metropolis” *International Journal of Environmental Issues* Vol. 8 No. 1 2010 pp. 76-86
- [8] S. I. Ladan “Achieving Effective Vegetation Cover in Katsina Urban Area, Katsina State Nigeria” *Global Journal of Science Frontier Research: H Environment and Earth Sciences*. Vol. 14 issue 3 pp 1-10
- [9] S. I. Ladan “Assessment of Waste Management and Control Strategies in Katsina Metropolis, Katsina State Nigeria”. *Journal of Research in National Development* Vol. 11 No. 1 2011 pp. 189-193.
- [10] S. I. Ladan “Assessment of Sewage Disposal Methods and Environmental Health Impact in Katsina Metropolis, Northern Nigeria”. *Journal of Life Sciences and Technologies* Vol. 2 No. 12014 pp. 38-42.
- [11] B. H. Mashi “Typhoid Fever: A Case Study of an Endemic Disorder in Katsina Metropolis” *Biological and Environmental Sciences Journal for the Tropics* vol. 5, No. 2 2008 pp. 27-30.
- [12] M. K. Danjuma “Point and Non-point sources of Pollution of Ginzo and Tilla Streams in Metropolitan Katsina: A Growing Threat to the Environment” Paper presented at 7<sup>th</sup> National Conference of Joint Colleges HUK Polytechnic, Katsina 2014.
- [13] I B. Lambu “Causes and Consequences of Open Space Defecation in Metropolitan Kano” *Techno-science Africa journal* vol. 6, No. 1 2011 pp. 77-82
- [14] S. I. ladan “An Analysis of Urban Floods in Katsina Metropolis, Katsina State” in A. B. Mamman, C. Chups and S. A. Mashi eds *Urbanization, Resource Exploitation and Environmental Sustainability in Nigeria* Joyce Publishers Kaduna pp 588-598.

# Traffic Analysis in the Reduction of Power Consumption in Cellular Radio Access Network

Shadrack K. Muendo, P. L. Kibet and S. Musyoki

**Abstract**— All over the world cellular network communication has become an integral part of people’s lives. This has changed how people behave and their demand for connectivity is anywhere and anytime. Understanding the subscriber calling patterns and behaviour is very important when planning for the network resources and carrying out network design. Traffic analysis is carried and is aimed at improving Quality of Service, determining the busy hour, estimating subscriber traffic usage, determining the amount of capacity (channel) required to satisfy a given number of subscribers in a cell or network among other reasons. This paper investigates the telecommunication traffic of a selected region. An analysis of the subscriber calling pattern will be carried out and a solution will be proposed on how to reduce power consumption in the cellular network based on traffic load.

**Keywords**— Cellular Network, Radio Network Planning, Power consumption, Communication, Traffic Analysis, Self-Organizing

## I. INTRODUCTION

ENERGY consumption in the Information and Communication Technology (ICT) sector is a major concern of the modern world because of the economic and environmental impact it has. Information and Communication Technology is responsible for up to 10% of the world energy consumption with telecommunication networks being one of the main consumers and contributes to 2% of the total Carbon dioxide emission of the world [1]. It is estimated that ICT energy consumption is rising at 15-20% per year [2].

In the past decade, the mobile industry has been grown rapidly connecting more than 4 billion people. In Kenya statistics from the Communications Authority of Kenya indicate that the mobile phone subscriber base is approximately over 32.8 million people [3]. To satisfy the increasing number of cellular network users and user requirements, more and more base stations (BSs) and Node Bs are being deployed to increase the network capacity.

Base stations are the main power consumers in mobile access networks consuming about 60-80% of the energy in a cellular network [4],[6]. There are currently more than 4 million base stations (BSs) serving mobile users, each consuming an average of 25MWh per year [5]. Under high traffic load the base stations are power-efficient. However, this is not the case during low traffic load.

S. K. Muendo, Department of Telecommunication and Information Engineering, JKUAT (phone: +2540726461736).

Subscriber traffic fluctuates highly both in time and over space, thus base stations incur energy waste. A lot of research

has been done to improve power efficiency in mobile networks as it can be seen in [6], [7] and [8]. With the technology trend moving towards self-organizing Networks, the European Telecommunication Standards Institute (ETSI) has proposed potential energy saving methods [9]. The concept of cell zooming that been used in outage compensation [10] can be used to adjust cell sizes dynamically to reduce energy consumption [11].

This paper provides traffic analysis for sites around JKUAT and proposes a solution on how to reduce power consumption in cellular access network.

## II. TRAFFIC ANALYSIS

Proper understanding of subscriber calling pattern is important for planning of resources. In this section statistics taken from 1st November 2013 to 4<sup>th</sup> January 2014 for six base stations around JKUAT are used for traffic analysis to show traffic diversity in time and space.

### A. Subscriber calling pattern

All over the world the desire to communicate is highest between 5pm and 9pm. The busy hour (period of peak traffic) is used for the planning purposes [12]. Statistics in Kenya shows a subscribers calling pattern with traffic being highest between 1900hrs and 2000hrs.

The statistics used for this investigation seem to suggest a constant calling habit by mobile users except for special cases like when there is graduation or the new year’s eve. The graphs below show the traffic patterns for various weeks and various weekdays. Fig.1, Fig.3, Fig.5, Fig.7 and Fig.9 show traffic plot for weeks 45,47,49,51 and 52 for Gachororo, Green field, Juja\_Hub, Kalimoni, Muigai\_Inn, Nyachaba sites which are located near JKUAT. Fig.2, Fig.4, Fig.6, Fig.8 and Fig.10 show average weekday hourly traffic plot for the six sites near JKUAT for weeks 45,47,49,51 and 52.

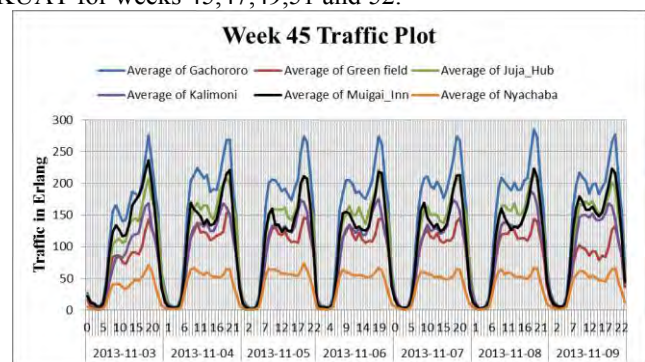

Fig.1. Week 45 Traffic Plot



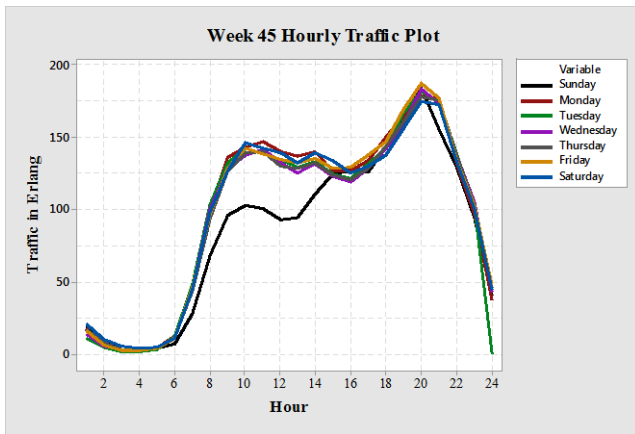

Fig.2. Week 45 Average Hourly Traffic Plot

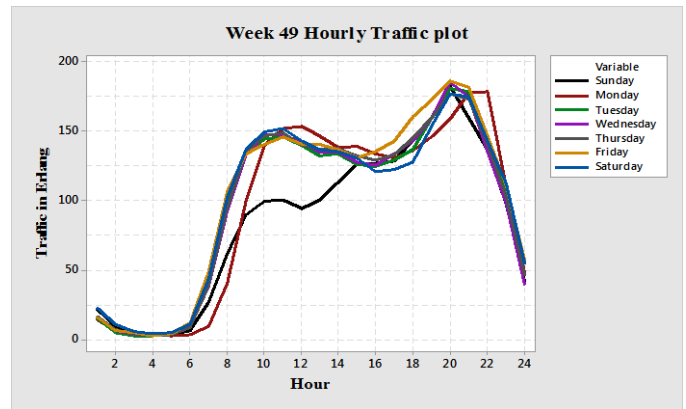

Fig.6. Week 49 Average Hourly Traffic Plot

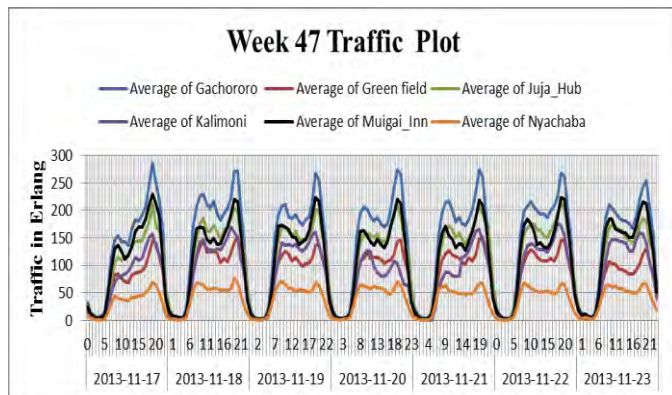

Fig.3. Week 47 Traffic Plot

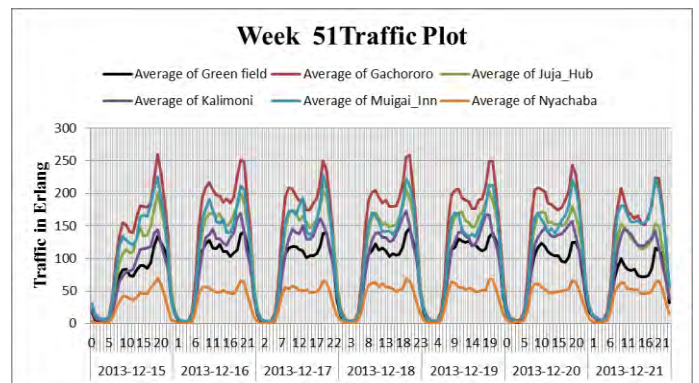

Fig.7. Week 51 Traffic Plot

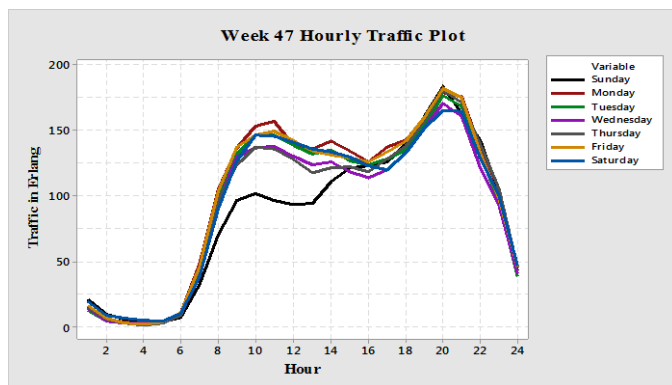

Fig.4. Week 47 Average Hourly Traffic Plot

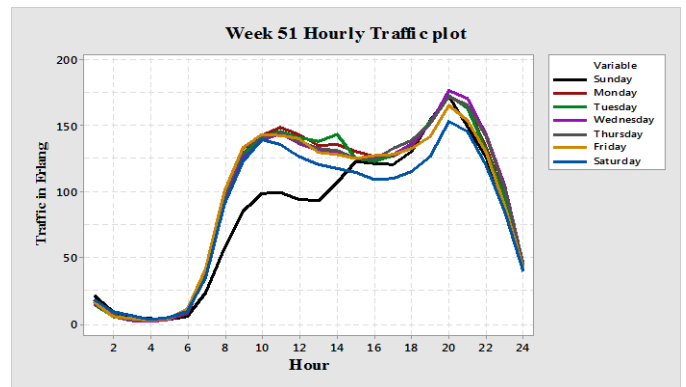

Fig.8. Week 51 Average Hourly Traffic Plot

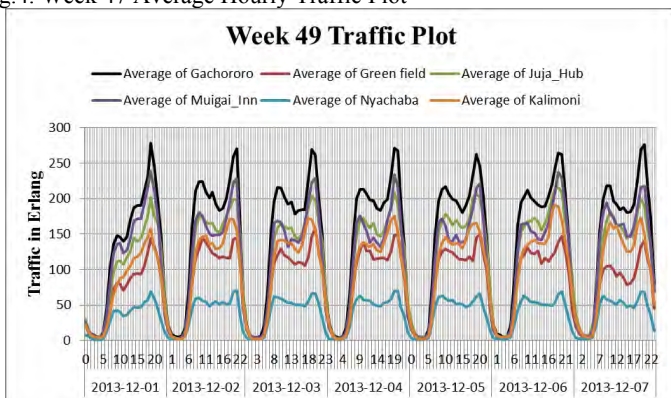

Fig.5. Week 49 Traffic Plot

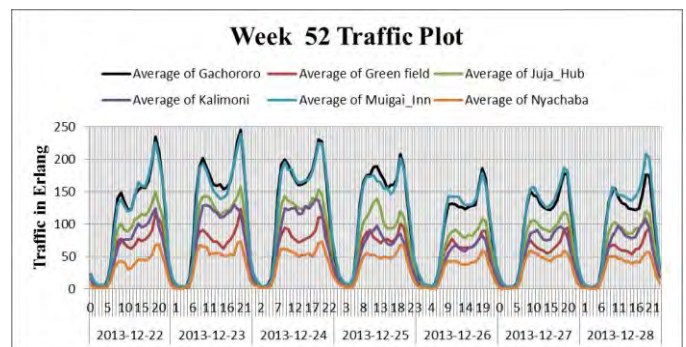

Fig.9. Week 52 Traffic Plot

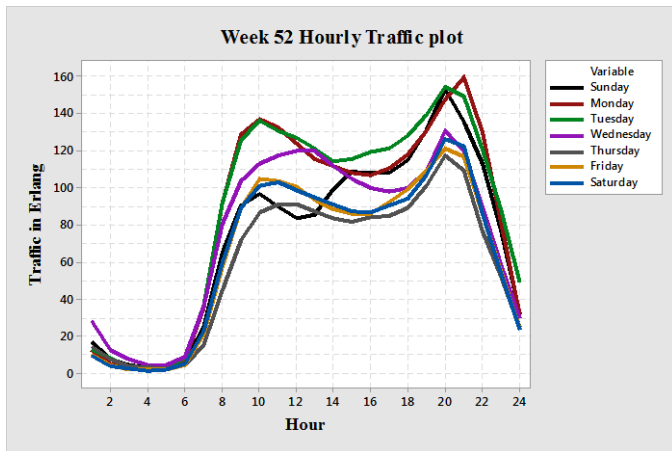

Fig.10. Week 52 Average Hourly Traffic Plot

From Fig. Error! Reference source not found. through Fig.10, the following observations can be made

- The traffic around JKUAT is predictable and uniform. The traffic is seen to begin at its lowest on weekends and gradually grows to a peak on Fridays and then drops to its lowest again on weekends.
- The peaks and troughs for the different sites seem to track each other. They follow the same pattern. When one goes high, the rest follow and vice versa. Thus, knowing the traffic trend for one site can give a representation of what is expected in other sites in the region.
- The traffic pattern is similar except on Sundays where the traffic growth is delayed but eventually catches up at around 1400hrs. The same pattern is replicated over the other weeks.
- Only 2 hours in a day have traffic above 85% of the peak traffic. That is, 1900hrs and 2000hrs. From 2100hrs to 1800hrs of the next day the traffic is below 85% of the peak traffic
- Fig.2, Fig.4, Fig.6, Fig.8 and Fig.10 shows the traffic trend for different days in a week. The same trend was observed for all the weeks. The traffic is below 20% from midnight to 5am and grows to its first peak at 9 a.m. after which it drops slightly up to 1600hrs. The next time traffic grows beyond the first peak is at 1700hrs, reaches peak between 1900hrs and 2000hrs and deeps to below 20% at midnight.
- Gachororo has the highest traffic load with Nyachaba having the lowest traffic load.

### B. Peak Traffic

An average of the daily traffic for the six sites during the period of study was plotted. This is shown in figure 11. The graph shows that only 4 hours in a day have traffic above 192Erlangs which represents about 77% of peak traffic. Only 2 hours have traffic above 220Erlangs. With the peak at 250 Erlangs, this represents about 88% of the peak traffic.

It can be observed from the profile that the traffic is below 20% between midnight and 5am and grows to its first peak at 9 a.m. which is around 77% of the total traffic. The traffic then stays between 70%-80% until 5pm where its rises and

peaks at 7pm then quickly drops to below 80% by 9pm and below 25% by midnight.

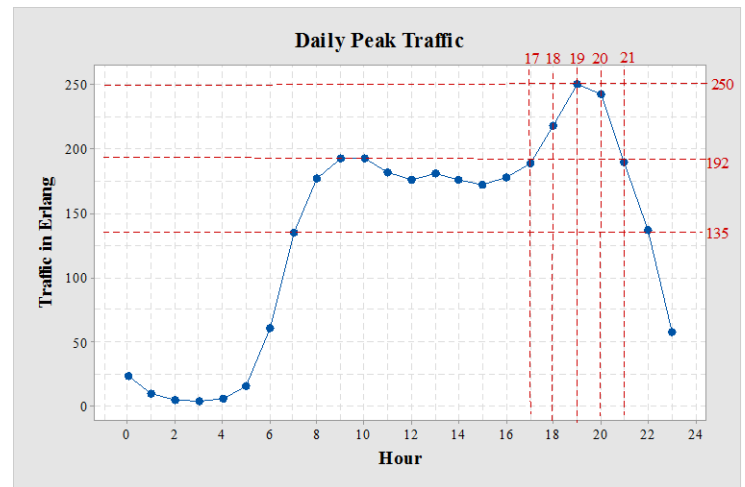

Fig.11. Peak traffic plot

This implies only 4 hours in a day have traffic beyond 80% of the peak traffic. This accounts for 16.7% of the hours in a day. Only 2 hours in a day are above 85% traffic, which is 7pm and 8pm that account for 8.3% of the hours in a day.

Network planners use the peak traffic to dimension the network meaning the base station is underutilized during the non-peak traffic hours. These results show that the traffic distribution of each Base Station is quite diverse over time. This diversity indicates the under-utilization of Base Stations in the time domain, resulting in system-wide energy inefficiency at Base Stations.

### III. DESIGN

Using the insights gained from the traffic analysis it is possible to achieve traffic load-adaptive energy consumption in cellular networks since it is possible to estimate the traffic envelope at any time. Since traffic varies over time and space, having a traffic driven energy adaptive system is very important. A solution that satisfies capacity, coverage and cost is proposed whereby the based station is operated dynamically. A busy day traffic profile was chosen. The concept is shown in Fig.12 and Fig.13.

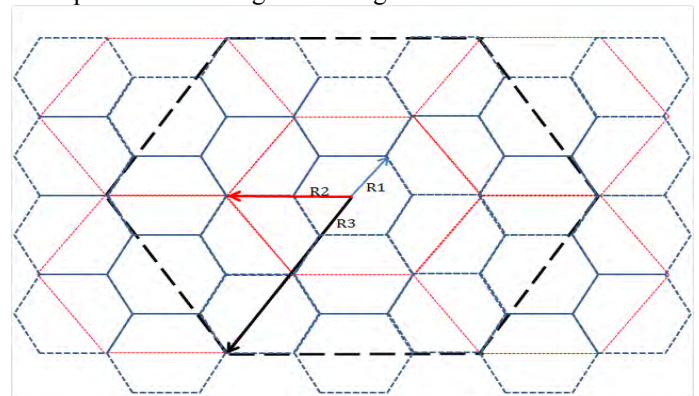

Fig.12: Dynamic operation of cells/Base Station concept

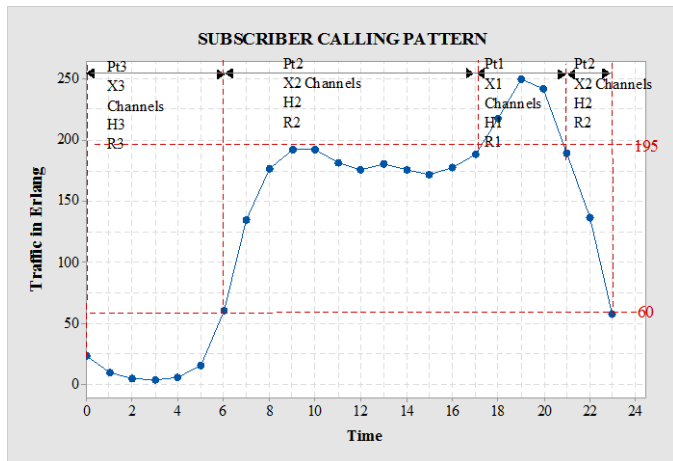

Fig.13: Subscriber calling pattern

The traffic profile can be divided into three parts:

- Part 1: This covers the period with traffic above 80% of the busy hour. This is where there is maximum utilization of base station resources. The cell can be allocated maximum resources. The cell size is minimum at R1.
  - Part 2: This covers the period where the traffic is between 25% to 80%.The cell size adjusts to R2 through change in height (H2) and change in transmit power (Pt2).The whole cluster reconfigures itself with some of the base stations being switched of and allocation of new channels(X2).
  - Part 3: This covers the period where the traffic is below 25% .The cell size adjusts to R3 through change in height (H3) and change in transmit power (Pt3).The whole cluster reconfigures itself with some of the base stations being switched of and allocation of new channels(X3).Fewer base stations are active which are able to cover a wider area.
- The proposed algorithm can be implemented as shown by the flow chart in Fig. 14.

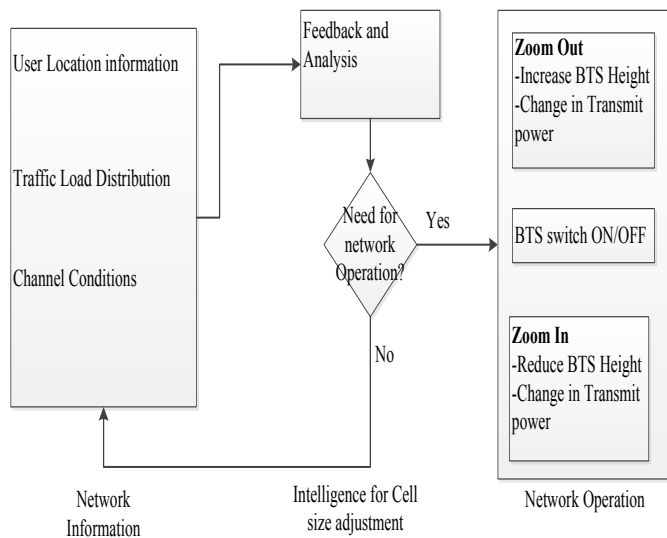

Fig.14. Flow chart of the proposed algorithm

The cells in a cluster can reconfigure themselves and adapt to the traffic profile. The size of traffic channels is calculated using Erlang B calculator or read from traffic tables. These

tables give the number of traffic channels (trunks) required to sustain a given traffic at a given probability of blocking.

The cell sizes can be adjusted through:

#### A. Change in Transmit power

The transmit power is given as [13], [14]:

$$P_t = k r_x^n \quad (1)$$

Where k is a constant Pr/c

$$C = \frac{G_t G_r}{LL_t L_r} \quad (2)$$

and

- Pr is the isotropic received power.
- Pt is the isotropic transmitted power
- L is the path loss
- r is the distance and n is the path loss exponent (typically 2-4)
- L and Lr are the feeder losses at the transmitter and receiver.
- L represents other losses
- Gt and Gr are the gains at the transmitter and receiver

From equation 1 it is possible to adjust the transmit power ( $P_t$ ) by adjusting the cell radius  $r_x$ . The transmitter power is equal to the nth power of the distance of the farthest user in the cell.

#### B. Change in Antenna height

Okumura Hata model is used to determine pass loss for a given height under different conditions. From the COST-Hata propagation model for urban areas the path loss is given by [15]:

$$PL = 46.3 + 33.9 \log f - 13.82 \log h_b - R_a(h_m) + (44.9 - 6.55 \log h_b) \log R_a + C \quad (3)$$

where

- PL is the maximum path loss in dB
- f is the frequency in Hz
- $h_b$  is the base station height in meters
- $R_a$  is the cell radius in km
- $h_m$  is the mobile receiver height in meters
- C is 0dB for medium cities and sub-urban areas or 3dB for metropolitan cities

After getting the value of the maximum path loss (PL) in dB from the link budget, the required radius ( $R_a$ ) or Base station height can be calculated as shown in equations 4 and 5 [14], [15].

$$R_a = \text{antilog} \left[ \frac{PL - 69.55 + (26.6 * \log f) - (13.82 * \log h_b - a * h_m)}{44.9 - 6.55 \log(h_b)} \right] \quad (4)$$

$$h_b = \text{antilog} \left( \frac{69.55 + 26.16 \log(f) - a(h_m) + 44.9 \log(d) - PL}{(13.82 + 6.55 \log(d))} \right) \quad (5)$$

#### IV. CONCLUSION

Energy efficient design has been an active research area in mobile networks. This paper is part of an ongoing research. From the preliminary results we have seen that the base stations are largely underutilized. Though many assumptions have been made it can be seen that with at least 25% reserve capacity available in the network for 20 hours a day, it is possible to adjust the cell size dynamically without needing additional capacity during this period. By automatically adjusting the cell sizes and turning off cells entirely at low traffic times will save some energy. The base station can quickly return to full coverage and capacity when demand increases. When reduction of energy consumption in cellular networks is achieved, it is expected to result in lower capital expenditure and lower operational costs. Further research will seek to develop a theoretical frame work for base station energy saving and recommend an acceptable practical design that can be adopted by operators as a step towards Self Organizing Networks.

#### ACKNOWLEDGEMENT

The authors gratefully acknowledge JKUAT and Safaricom for their support.

#### REFERENCES

- [1] E. Zimmermann and G. Fettweiss, "ICT energy consumption-trends and challenges," in *Proc. of IEEE WPMC*, Lapland, Finland, 2008, pp. 2006-2008.
- [2] A. Fehske, G. Fettweis, J. Malmodin, and G. Biczok, "The global Footprint of mobile communications: The ecological and economic Perspective," *IEEE Commun. Mag.*, vol. 49, no. 8, pp. 55-62, Aug. 2011.
- [3] Communication Authority of Kenya, "Sector statistics," CCK, [Online]. Available: [http://www.ca.go.ke/images/downloads/STATISTIC S/Sector%20Statistics%20Report%20Q1%202014-2015.pdf](http://www.ca.go.ke/images/downloads/STATISTIC%20Sector%20Statistics%20Report%20Q1%202014-2015.pdf) [Accessed 20 February 2015].
- [4] J. T. Louhi, "Energy efficiency of modern cellular base stations," 29<sup>th</sup> International Telecommunications Energy Conference (INTELEC), 2007, pp. 475-476, Sept. 30 2007-Oct. 4 2007.
- [5] Z. Hasan, V. Bhargawa and H. Boostanimehr, "Green cellular network: A survey, some research issues and challenges," *IEEE Communications Surveys and Tutorials*, vol. 13, pp. 524-540, 2011.
- [6] L. Josip, T. Garma and P. Goran, "Measurements and Modelling of Base Station Power Consumption under Real Traffic Loads," *Sensors*, vol. 12, pp. 4281-4310, 2012.
- [7] S.K. Muendo, Philip Kibet, and Stephen Musyoki, "Reduction of power consumption in cellular Radio Access Network," in *Sustainable Research and Innovation(SRI)*, AICAD, Juja, 2014, pp. 277-280.
- [8] S. N. Roy, "Energy Logic: A Road Map to Reducing Energy Consumption in Telecommunications Networks," *IEEE INTELEC*, pp. 90-98, San Diego, September 2008.
- [9] ETSI TR 136 927 V10.1.0, "Evolved Universal Terrestrial Radio Access (E-UTRA); Potential solutions for energy saving for E-UTRAN(3GPP TR 36.927 version 10.1.0 Release 10)," European Telecommunications Standards Institute, 2011.
- [10] Symon Manegene, Philip Kibet, and Stephen Musyoki, "The use of cell zooming for outage compensation in cellular Radio networks," in *Sustainable Research and Innovation(SRI)*, AICAD, Juja, 2014, pp. 258-261.

- [11] N. Zhisheng, Y. Wu, G. Jie and Y. Zexi, "Cell zooming for cost-efficient green cellular networks," *IEEE Communications Magazine*, vol. 48, no. 11, pp. 74-79, November 2010.
- [12] H. Hu et al, "Self-configuration and self-optimization for LTE networks," *IEEE Communications Magazine*, vol. 48, pp. 94-100, 2010.
- [13] C. A. Balanis, *Antenna Theory: Analysis and Design*, Wiley Interscience, 3rd ed, 2005.
- [14] J. Volakis, *Antenna Engineering Handbook*, McGraw-Hill Professional, 2007.
- [15] C. Dalela, "Comparative Study of Radio Channel Propagation and Modeling for 4G Wireless Systems," *IJEAT*, vol. 2, no. 5, pp. 296-299, June 2013.

# The Proposed Gemstone Centre and its Likely Impacts on Small Scale Mining Industry in Taita Taveta County

Seroni Anyona and Bernard K. Rop

**Abstract**— Plans are at an advanced stage to build a Gemstone centre at Voi in Taita Taveta County by the National government. This is a major development that will transform the gemstone industry forever. This Gemstone Center will address the thorny problems of the industry that have been arresting its breakthrough once and for all. This Gemstone Center will provide a wide range of services including gemstone banking, state of the art gemstone laboratories, gemstone buying centre, gemstone cutting and polishing laboratory, among others. This will enable the Artisanal and Small-Scale Miners access international markets within their locality. Consequently, it is likely to eliminate a number of players along the value chain and cut out the current cartel of landlords and brokers ensuring more income to artisan miners. Since Artisanal and Small-Scale Miners (ASM) have been informal they often form partnerships with brokers who act as ‘supporters or sponsors’. This was evident at Mkuki, Kasigau and Alia gemstone mines. The brokers would provide the miners with food, water, mining equipment, contingency funds and any other relevant item critical to the process of mineral exploitation. Most of these brokers are exploitative as they get a large portion of the sales from the gemstones, since they are accorded the rights to sell the gemstone leaving only a small percentage to the actual hands-on miners. The benefit-sharing between the miners and the brokers in most cases is tilted towards the later. Hence this study seeks to examine the possible impacts of the Gemstone Center to the gemstone industry in the county with regards to the value chain and commercial interactions. The information provided was collected in the month of November 2014 which involved interviewing a number of the stake holders

**Keywords:** Gemstone Center, gemstones, brokers, landlords, laboratories, cutting and polishing, interventions, donor, ASM

## I. INTRODUCTION

The management of extractive industries is one of the most critical challenges facing many resource-dependent developing countries today. Rather than stimulating broad-based economic development, reliance on resource extraction has tended to concentrate wealth and power in the hands of a few. It also exacerbates corruption and inequalities leading to environmental degradation and pollution, while doing little to reduce poverty, economic disparities and generate employment.

Southern Eastern Kenya University, School of Earth Sciences, Institute of Mining and Mineral Processing Department of Geological Science P.O. Box 33542 – 00600, Nairobi, Kenya. (seroni20@yahoo.com)

Jomo Kenyatta University of Agriculture & Technology, Mining, Materials & Petroleum Engineering Department, P.O. Box 62000 – 00200, Nairobi, Kenya (e-mail: droppen@gmail.com).

According to government estimates, extractives currently contribute just 1% to Kenya’s GDP and in terms of total export revenues it is less than 2%. This contribution is set to grow significantly (current estimates suggest the sector may grow to 10% of GDP) and the opportunity to use the sector to catalyze transformational national development and economic growth requires careful planning at this critical and early stage [1, 2]

Kenya is well known for gemstone mining; however, the small-scale (artisanal) miners dominate the industry. Artisanal mining accounts for over 60% of annual gemstone production in Kenya; women and youth play a major role in artisanal mining. Artisanal and small-scale mining (ASM) directly and indirectly employs a number of people in Taita Taveta County (TTC) on temporary basis. This income generating activity by the ASM plays a very important role by providing vocational jobs that sustain the livelihood of the population. The economic impact on the county and the national economy at large is significant as a large proportion of national gemstone mining production comes from ASM sources. It is difficult to obtain accurate information on exact ASM numbers in the county, given that it is considered informal or illegal in nature. ASM population continues to grow in the county.

In 2002 Kenya had an estimated production of 10.9 tones of Ruby corundum (5.86 tones in 2001) and 61.4 tones of gemstones compared to 73.3 tons in 2001[1]. There has been a decline in Kenya's gemstone mining industry recently; with the same traditional players continuing to dominate the sector. It is this critical role played by the sector that necessitates a deeper understanding, analysis and appreciation of its socio-economic impacts in Taita Taveta County.

Conflicts over land endowed with minerals have been reported in the gemstone areas of TTC. The potential areas for gemstone mining are usually grabbed by prospectors who are large-scale miners (LSMs) to the detriment of the ASMs. Trading relationships in ASM can be complex. Often a purchaser also fulfills the role of creditor and may have a degree of control over the workers through remoteness, indebtedness or threat. Alternatively, the purchaser may be the preferred trader based on loyalty and a value-adding relationship. Some interventions seek to remove the middlemen and traders from the ASM supply chain in order to improve the return to the miners; however, caution is required as supply chains such as these have evolved to operate within their context and attempting to change them may have

unintended negative consequences; may be resisted; or the change may be unsustainable. A weakness in ASM is the lack of technical facilities and organization within the sector. Formalization of ASM could improve representation to government and the market; strengthen price bargaining; allow pooling of resources for credit and development; and help to achieve economies of scale. Establishment of state-of-the-art gemological facilities will greatly improve the livelihoods of the population and increase revenue to both county and national government.

It is with this in mind that the County Government of Taita Taveta has allocated one (1) acre of land to the Ministry of Mining for the purpose of setting up a gemstone Centre for gemstone value addition before marketing.

The National Government through the Ministry of Mining has also set aside thirty (30) million shillings (\$333,000), in its 2015 annual budget, for the construction and equipping of the Gemstone Centre.

## II. STUDY AREA

This scoping research which was funded by UNDP in collaboration with the Taita Taveta county government was carried out between August and October 2014 in the county.

Taita Taveta County lies in the south-western part Kenya's coast. It is bounded between longitudes  $37^{\circ} 30' 00''$  and  $39^{\circ} 30' 00''$  East and latitudes  $2^{\circ} 30' 00''$  and  $4^{\circ} 30' 00''$  South. It is approximately 200 km northwest of Mombasa and 360 km southeast of Nairobi. It borders Makueni, Kitui and Tana River Counties to the North; Kilifi and Kwale counties to the east; Kajado County to the Northwest and the Republic of Tanzania to the Southwest

The county has an undulating and rugged terrain with an altitude ranging from 500 m to almost 2,300m above sea level with Vuria peak being the highest. The rainfall varies according to the terrain with the lower zones receiving an average 440 mm of rain per annum and the highland areas receiving up to 1900 mm of rain

The population of the county 30 years ago was approximately 45,000 persons but this has shot up to well over 284,657 persons (2009 census) with population densities ranging from 3 persons per  $\text{km}^2$  to more than 800 persons per  $\text{km}^2$

The county covers an area of 17,083.9  $\text{km}^2$  (6,596.1 sq mi) of which a bulk 62% or 11,100  $\text{km}^2$  is within Tsavo East and Tsavo West National Parks. The remaining 5,876  $\text{km}^2$  is occupied by ranches, sisal estates, water bodies such as Lakes Chala and Jipe in Taveta and Mzima springs, and the Hilltop forests which occupy less than 100  $\text{km}^2$  or approximately 10  $\text{km}^2$  out of 587.5  $\text{km}^2$ .

The lowland areas of the county that do not belong to national parks are divided to ranches, estates and wild life sanctuaries. The county has approximately 25 ranches. The main land use in ranches is cattle grazing. The three operating sisal estates of the district are the Teita Sisal Estate, Voi Sisal Estate and Taveta Sisal Estate. The ranches are also used for wildlife conservation and tourism. The famous Taita Hills and Saltlick Lodges sanctuary are located in the county.

The economic activities practiced in TTC by the local communities are livestock keeping, small-and large-scale mining, small-scale subsistence farming and small- and micro-enterprises and/or businesses. Some of the people are employed in various public and private institutions in the County.

In 2007, the Taita-Taveta District was split into two districts: the Taita District and the Taveta District. The two were subsequently merged to form Taita-Taveta County. This consists of four constituencies namely, Voi, Mwatate, Wundanyi and Taveta. There are 20 county wards which include Mwanda/Mgange, Werugha, Wumingu/Kishushe, Wundanyi, Mwatate, Bura, Chawia, Wusi/Kishamba, Sagala, Kaloleni, Kasigau, Ngolia, Mahoo, Bomani, Mboghoni, Ronge, Mbololo, Marungu, Chala, and Mata.

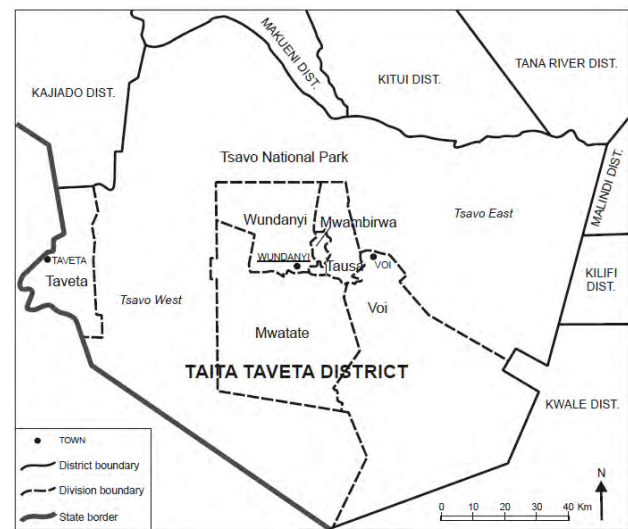

Fig. 1: Location Map of the Taita Taveta Districts

### A. Geology of Taita Taveta area [4]

The Taita Taveta area is situated within the Mozambique Belt, a major structural/metamorphic unit which extends along the African east coast from Mozambique and Malagasy into the Sudan and possibly as far north as Egypt and Arabia; it represents one of the fundamental geological features of Africa [6]. The belt consists typically of high-grade metamorphic rocks, characterized by K/Ar-ages of 400-600 m.y. [5]. Three major units were recognized in southern Kenya [4].

Relics of older-metamorphic basement occur as wedges and slices of charnockites and granulites, tectonically emplaced within meta-sediments. Variegated mio - geosynclinal meta-sediments, consisting of marbles, quartzites, graphite and kyanite (-sillimanite) gneisses and schists, biotite (-hornblende) gneisses and amphibolites which were deposited as a sedimentary cover with volcanic intercalations upon the basement.

Eu-geosynclinal meta - sediments are considered to be represented by a thick suite of monotonous meta-greywackes (quartz-feldspar-biotite-hornblende gneisses) with bands of ortho-amphibolites, termed "Kasigau Series" immediately to

the east of the Taita area [3,6]. This unit probably was deposited on a continental margin.

Facies transitions between the two series suggest approximate time equivalence. The present contact between the two groups is apparently concordant. It is marked by lenses of meta-dunitites, peridotites and –basalts possibly representing dismembered ophiolites along a regional thrust.

### B. Economic Geology

Geological reports of surveys carried out at different times in this region show the presence of mineral deposits in the County and the neighboring areas. A report by Horkel [4] shows that parts of TaitaTaveta County has high and middle value gemstones including: Tsavorite (green garnets), red garnets, ruby, change colour, blue sapphire, pink sapphire, green tourmalines, yellow tourmalines, rhodolites and kyanites. The main gemstone mining area in Kenya is in the Tsavo region, which derived its name from tsavorite [3]. Many small mining operations are located along a fault system extending from the Taita Hills of Kenya to the Uмба Valley in northern Tanzania, passing through the Tsavo, Kasigau and Kuraze areas. This is where Campbell Bridges discovered tsavorite in 1971 and where his company continues to carry out mining. TaitaTaveta County is currently the main source of Tsavorite in the world.

Rubies are associated with ultramafic rocks while *greengrossularites* (“Tsavorite”) is strata-bound. Other gemstones include *blue zoisite* (“Tanzanite”), *andradite*, *Red spinel*, *turquoise*, and *Amethyst*. The production of graphite, particularly from the Chawia deposit may also prove economically feasible. Less promising mineralization, mainly with a potential for domestic markets, are magnesite and asbestos occurrences in ultramafic bodies or kaolin and magnetite deposits. The development of bulk commodities such as marble and structural stone depends mainly on an adequate local market potential.

Marble is available for quarrying east of Mwatate on a small scale. Owing to a high Mg (Magnesium) content, the rock is not suited for the manufacturing of cement, but merely for burning to produce lime, and as dimension stone or aggregate. Small quarries for basalt, gneiss and lapilli supply the local requirements for road metal and aggregate. Ample resources of these low-value bulk commodities are readily available for development if required by increased local demand. Building stones (tuffs) are currently being quarried near Taveta town and there is a potential for further expansion if more resources are invested and the demand is right. There is sufficient supply of sand to satisfy the needs of the area and even surplus to sell to the neighboring counties [4, 5].

Taita Taveta County is therefore endowed with one of the richest minerals deposits in Kenya and the Eastern Africa region [4, 7, 8] These include both industrial minerals and gemstones, which have the potential of generating considerable wealth to various mining prospectors and investors [9]. But this wealth does not trickle down to the local people. This wealth continues to benefit middlemen, brokers and other players along the supply chain while poverty in the

county continues to spread unabated [7]. Furthermore, the mining is often carried out without clear government regulations, support and control [7].

### C. The Relevance of the Study

Due to its importance as a location of minerals, particularly gemstones [8], considerable information exists about mining in Taita Taveta County. However, most of the research and publications address the natural science and geological issues, since they are driven by prospector, investor and trade interests. Consequently, little has been published about the political, economic, social and environmental impacts of mining in the County. So this study was commissioned to analyze the dynamics and value chain of the gemstone industry with the main of assisting the stakeholders, policy makers and the donor community to formulate effective interventions where and when necessary.

This calls for further research focused on the, economic, social and environmental perspectives and the benefits that would be accrued from proposed developments in the sector. Critical here is the need to include the relationship between the people of the mining areas, the environment and the mineral resources. Such research would also sought to explore more cogently why local people continue to be losers in the exploitation of the mineral resources in their ancestral lands and how the proposed gemstone centre will help reverse this. Given that Taita Taveta County is endowed with abundant minerals it was important to find out the likely impacts of the establishment of this centre as major game changer in the area.

It is also important to estimate the benefits that will be accrued from an industry that is reputed to make billions of shillings in profits annually as revenue, and whether the current policy, regulatory and legislative framework in the Extractive Resources Industry (ERI) adequately address the issues of royalties and benefit sharing between the investors, communities and government, as compared to best-practices from other countries with natural resources. So there is need to determine why the industry and trade in minerals has not brought about the development of local communities around mining areas [9].

## III. MATERIALS AND METHOD

The study materials and data were gathered in the period of September-October 2014 in the county. The empirical materials consisted of RPA (Rapid Rural Appraisal) and in-depth interviews, unstructured interviews, questionnaires and desk references, literature review of existing information, reports, journals and field observations as well as review of relevant Kenyan laws on mining. The field studies began by an excursion as part of the RRA. The interviews were carried out by a team of professionals. The study mainly focused on the areas where mining is taking place. These included Chawia, Mwatate, Kasigau, Alia, Kishushe, Mkuki, Buguta, Ongoni (Voi River), Bura, Taveta and Wundanyi areas.

Information derived from this study was gathered by expert interviews, more unofficial unstructured interviews (representing RRA-approach) and questionnaires, of which the

target groups were the administrative officers of Taita Taveta County, established miners and mining companies as well as the local civil society and whistle blowers.

In addition to these interviews, the research team held several informal discussions, or unstructured theme interviews of which the most valuable took place with the TaitaTaveta County governor H.E Eng. Mruttu, some members of the county assembly, mining committee especially the chairman Mr.Mwangola, experienced and long serving miners, brokers and opinion leaders. The Principal of TTUC Prof Boga and Chairman of Mining and Mineral Processing Engineering department TTUC Mr. Ndegwa added value to the study since the institution has been involved in providing solutions to the mining industry. The current government regional geologist, Mr. Omito, provided critical information and guided the research team in field excursions. The team also worked closely with the acting County Executive Committee (CEC) Member in-charge of the Ministry of Mining, Environment, Wildlife and Natural Resources, Ms. Pamela whose input and information regarding the industry was invaluable. The questions were open-ended to elicit broad insights from the respondents on the extractive industry in the county, the activities of their organizations, the challenges faced and their recommendations.

In total, over 150 (Table 1) artisanal miners were interviewed, 20 local brokers and 10 key small scale miners namely; Musa G. Njagi, Gabriel Mcharo, Miceni Musa, Edith Lewela, Joseph Mtwandei, Major Mtongolo, Jared Nzano, David to mention just a few, were also interviewed in-depth.

**Table 1: Proportion of mining activities in study area**

Miner category	Total interviewed (%)
Gemstone Miners	74
Building stone miners	20
Sand and other miners	6

This study attempted to use both probability sampling and non-probability sampling during selection of the artisanal and small-scale miners as well as brokers and other stakeholders.

The study involved both quantitative and qualitative methods. However, more emphasis was put on qualitative field data collection. The aim was to generate living data on mining in Taita Taveta by interviewing the stakeholders in the mining industry in the area.

The past media coverage of the mining activities in TaitaTaveta County and the associated political dynamics were also examined to highlight the socio-political nature of the industry and the ensuing conflicts.

The collected information from the questionnaires and interviews as well as the documents received from the key stakeholders were analyzed using standard statistical methods with the aim of presenting an accurate and unbiased assessment of the issues affecting the sampled population.

#### A. Numbers of ASM Workers and Dependents

It is notoriously difficult to collect accurate information on this sector given its informal and unregulated nature,

seasonality, migration, use of ASM as a supplementary or back-up income source, etc. However, it is generally agreed that ASM is growing and this is an invisible income generating activity. According to the national government's records there are 512 recognized mining allocations most of which are licensed and two operating on government leases namely Bridges Exploration Ltd and Rockland (K) Ltd. Of the 512 licensed miners a number of them are out of operation due to various reasons ranging from attrition, financial problems, conflicts and other personal problems.

Apart from government records we were able to get lists of members of a number of mining associations and self-help groups (Table 2). The estimated the number of dependants can be computed by using the 2009 population and household census which gave an average of 6 persons per household. Assuming each member of the associations identified below represents one household and that each has children, then the number of dependants can be estimated by multiplying the number of members by six.

**Table 2: No. of people directly or indirectly dependent on mining**

No.	Name of Association/Co.	Est. No. of Members	Est. No. of dependants( multiply 6)
1	Mkuki Mine	140	840
2	TaitaTaveta Women Mining Group-Alia	300	1,800
3	MuonganoGwaloli Mining Group-Buguta	150	900
4	TimboMlimani	400	2,400
5	TimboKubwa	150	900
6	Lukundo Mine	100	600
7	Alia Mining C.G	234	1,404
8	Licensed miners	512	2046
9	Rockland (K) Ltd	41	246
10	Bridges Exploration	6	36
11	Tsavolite Mine	41	246
12	Ongoni area-Voi River(sand)	50	300
13	Wanjala Mining-Kishushe	600	3,600
14	Mama Mercy Miners	200	1,200
15	Others	300	1,800
	Total	2,684	19, 344

This is a very rough estimation which excludes miners that do not belong to any association and operates on many assumptions. But even going by this alone, one can get an impression of the sheer size of people who directly or indirectly depend on this industry. This is considered an underestimation and therefore a much larger number of people are supported by the extractive industry in this area.



### B. Stakeholders' Workshop

After the completion and compilation of this study a stakeholders' workshop was held between 15<sup>th</sup> and 19<sup>th</sup> December 2014 to disseminate the study findings and receive feedback from the participants. The mining communities were represented by different groups and/or individuals involved in the study.

### C. The Current ASM Methods, Processing and the Value Chain

Artisanal and small-scale mining is carried out in many different ways depending on tradition, geology, geography, the nature of the minerals, and available resources. Prospecting and exploration are usually done in the most basic manner and uses a mix of tradition, opportunism, rumors, observation and luck, all these techniques being refined and perfected over a period of time. The main indicator of presence of mineralization is alluvial deposits which the miners first dig up and then follow underground.

Over time, artisanal miners have developed an understanding of the local geological formations in which these gemstones occur and this has acted as their guiding principle in the prospecting and digging operations. Very few if any, mostly small-scale miners with access to geological information, employ the use of formal prospecting in their mines. Lack of information and therefore a lack of in-depth understanding of the geology of these gemstone mining areas hinder the efficiency of mining as most operations essentially amount to trial and error, wasting a lot of time, effort and resource.

Mining operation of any Ore body can either be underground or surface, and it ranges from manual to mechanized. Gemstone mining also follows this trend, most of it beginning from alluvial deposits on the surface and then advancing underground depending on the mineralization. Alluvial deposits of gemstones were a common occurrence in the early days (60's, 70's, 80's) when the sector was budding with only a few people involved, but with more and more players coming into the picture, it is very rare to find alluvial gemstones these days. Most gem mining is done underground at present with mineralization tending to occur deeper and deeper in the ground as near surface deposits become exhausted.

Mining of these deposits is a tedious undertaking given the effort required to break rock and primarily involves the use of hammers, chisels, shovels and buckets and in some advanced cases drills, compressors, explosives and excavators. Artisanal miners usually apply the most basic of techniques to laboriously dig up box-cuts then tunnels underground as they follow mineralized reefs/zones.

Loose soil normally forms the overburden but this soon turns to hard host rock which requires immense effort to dig through. This is done manually using hammers and chisels, pneumatic rock drills and aided in some cases by prior blasting to loosen the rock. Tunnels dug out in this manner in some instances go more than 50 meters underground, with diameters large enough to allow crawling or crouching as one

goes in. Adequate space is, however, provided at the work front to allow for digging and movement of material. Waste rock is usually removed manually using shovels and buckets or sacks but as the tunnel gets deeper, removing waste becomes a tedious task; with most miners preferring to spread it on the tunnel floor or collecting it in one area.

Small-scale miners employ more or less the same method of mining, the only difference being that they are able to employ machinery such as excavators, generators, water pumps etc. This enables them to mine in a relatively more planned and structured manner as compared to artisanal miners owing to more information, better prospecting and a larger pool of resources. In both cases, support of the mined out areas is not of much concern to the miners as they deem the host rock to be competent enough to support itself, though few pay attention to the fact that it is dangerous especially during the rains.

Most of the gemstones once mined, usually do not undergo any form of processing or treatment. They are just separated from the surrounding rock which they are normally associated with and thereafter sold as just raw or uncut stones to brokers who frequent mine sites, or in nearby towns of Mwatate and Voi. However, few brokers or experienced artisanal miners attempt to add value to the gemstones. A simple process may involve: separation (sorting after extracting the gemstone) this is done by hand, washing (using water) and shining (using glycerin).

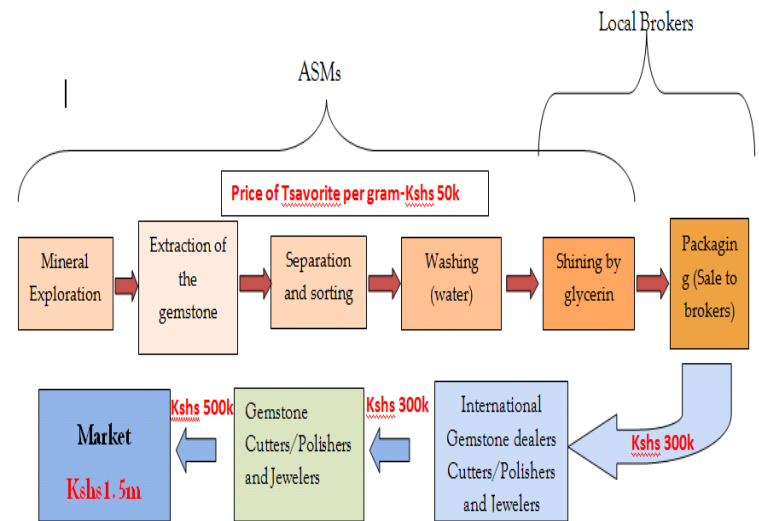

Fig 2: Estimated increase of Tsavorite prices up the value chain

(The prices stated are for a good quality Tsavorite per gram in Kshs just for illustration and are rough estimates)

The activities involved at every stage of the value chain may be presented as shown below.

### D. Royalties

The law provides that royalties are paid for all minerals. The rates of royalties are negotiable within the commonwealth countries' rates.

From the mineral export data acquired from the Ministry of Mining, the gemstones from Taita Taveta County significantly

contribute to Kenya's foreign income earned from minerals - about 25%. Most of these gemstones are mined by ASMs. The royalties paid by the exporting companies, operating in Taita Taveta County, are noticeably small compared to the earnings as per the available data. Out of a total of Kshs115,851, 273 earned from gemstone exports only Kshs 5,125,485 or 4.42% was paid as royalty. These earnings do not trickle down to the county creating discontent and resistance to the mining activities within the local community.

#### IV. THE ESTABLISHMENT OF GEMSTONE CENTRE IN TAITATAVETA

##### A. Introduction

The idea of building a Gemstone in Taita Taveta County has been a subject of discussion by the stakeholders for a while now. The need to maximize on the benefits accrued from the mineral resources from the area has been the driving force behind this. The country's inability to process the gemstones has for long denied the industry commensurate earnings thereby benefiting foreign companies disproportionately.

The Ministry of Mining recently created the Directorate of Mineral Processing and Value addition and the first assignment for the department is to establish the Gemstone Centre. A number of stakeholder consultative meetings have been held and the program is ready to proceed.

The objective of this paper is to postulate the likely socio-economic, environmental, and political impacts of this proposed centre, given the number of people directly or indirectly depending on this sector. Based on the field study and experience in the industry, the paper will also endeavor to give recommendations on how best this critical program may be implemented for the realization of maximum returns. To do this we need to first appreciate the general organization, structure and services that will be provided by the centre

##### B. Objectives of the Gemstone Centre

The anticipated establishment of the Gemstone Centre in Taita Taveta has the objectives of:

- i) Ensuring value addition on the gemstones to increase income for artisanal Miners and revenue to the government
- ii) Providing avenue for marketing of cut gemstones to potential buyers
- iii) Providing training in gemology and academic research
- iv) Combating smuggling of gemstones across our Kenyan border
- v) Storing data and information on production and exports of gemstones in Kenya

##### C. Land Allocation

The County Government of Taita Taveta has donated close to one (1) acre land for the Gemstone Centre within the Voi Township to the Ministry of Mining for the establishment of the Centre.

##### D. Resources

The government of Kenya through the Ministry of Mining has provided in its budget thirty million (30,000,000/=) towards the establishment of this Centre in the Financial Year 2014/2015. Of this amount, twenty million is set aside for the building while ten million will be utilized for the purpose of buying equipment for the Centre.

The Ministry of Mining will provide contracted expertise and labour for the construction of the building and for equipping the Centre.

Personnel to manage the Centre on day to day basis will be provided by the Central Government through the Ministry of Mining. The County Geologist resident in Taita Taveta County will coordinate and oversee much of the activities relating to the operations at the Centre.

##### E. Design of the Building

It is envisaged that the building shall be storey type to save on the scarce land so that space may be available for other activities and future expansion.

A two storey building is ideal for such a Centre to cater for the anticipated high activity around the Gemstone Centre as it is set to attract regional participation (however for the start it will be one storey due to financial constraints). The Centre will be designed with features that depict the prominent gemstones in the area. *(A draft design of the Centre is here attached for further inputs and adjustments).*

The construction and landscaping of the Centre shall be done by a suitably qualified Contractor, who will be selected through competitive bidding. The building will comprise various compartments that are proposed to accommodate and serve key undertakings including;

##### a) Lapidary

This will be the section that will deal with value addition in the Centre. The lapidary will have equipment for cutting, polishing, faceting, sawing, drilling, jewelry making and may be at a later stage heat treatment.

##### b) Gemology Laboratory

The laboratory to be established in the gemstone Centre should have the capability of *issuing certificates* that are recognized worldwide. For this to happen, the laboratory should be affiliated with International bodies like the Gemological Institute of America (GIA), London Gemological Association (LGA), International Colored Gemstone Association (ICA) and other gemstone bodies

The laboratory should be manned by qualified gemologists given the sensitivity associated with gemstones worldwide. It should also be opened daily except on weekends and public holidays.

The equipment that will be initially based in the laboratory products are;

- Refractometers
- Polaroscope
- Dichroscope
- Gemological Microscope
- Specific gravity balance

- Electron balance
- Chelsea filters
- UV and Infra-red Spectrophotometers
- Laser Inscription Machine
- Diamond testers

*c) Exhibition Hall*

The gemstone Centre will have an exhibition hall that will be used for exhibition purposes. According to views from stakeholders, there should be days when an open market is conducted at the Centre and gemstone dealers invited to take up booths within the Centre. Government officials should also be on standby to offer Export Permits when they are required.

The Centre should be able to conduct one international gemstone fair once in a year to attract international dealers.

*d) Administration offices*

The gemstone Centre should have offices for government officials and people who will be running the Centre in conjunction with or on behalf of the Government. Government should also facilitate issuance of export permits within the Centre and any other service that should be offered by the Government.

Payment for gemstone processing by mineral dealers will enhance the Ministry's revenue collection and create more employment to Kenyans. All payments at the Centre will have to be received.

*e) Security*

This Centre should be under 24 hour surveillance of CCTV to ensure that there is security.

There should be security safes where dealers can keep their gemstones for safe keeping especially during exhibition days when they are conducting business.

The area should be under 24 hour guard by the Kenya Police or any other Security providers that will be appropriate.

Barriers and special scanners will need to be installed at the main gate in addition to the above measures taken to ensure that the no one enters the Centre with any dangerous object.

*f) Banks*

Allowance will be made for banking facilities in the Centre to facilitate financial transactions. This will reduce the risk Mineral Traders are likely to be exposed to after selling their.

*g) Restaurant*

This will provide the people at the Centre with food and refreshments to cut down on time wastage in looking for eating places. It will also contribute to total revenue collection.

*h) Infrastructure*

Electricity and water will have to be connected to the as required. Road leading to the Centre will be upgraded. The Centre will have ample parking space to accommodate the influx of vehicles.

*i) The Gate*

A modern gate with electronically controlled barriers and scanners to detect dangerous objects and substances will be constructed. The gate must comprise a room for the guards to shelter and ensure they are always present.

*j) Fencing*

A perimeter fence will be constructed to improve the security and control unnecessary interference

*F. Time schedule for the establishment of the Gemstone Centre*

The Table 3 provides guidelines for the timing of activities to be accomplished at every stage of the project. Since this is one of the flagship projects of the Ministry of Mining and is captured in the Performance Contract for this year, it should be completed before the end of this year.

Table 3: Timing of activities

Activity/Duration 2014/2015	2014				2015					
	S	O	N	D	J	F	M	A	M	J
1.Acquisition of land										
2.Develop design for building										
3.Preparation of BQs, Flotation and Opening of tenders for construction and Awarding of Contractor										
4.Hand over of site to contractor and groundbreaking ceremony										
5. Tendering/Procurement of Lapidary and Laboratory Equipment.										
6.Construction of Centre										
7.Equipping the Centre with the procured equipment										
8. Commissioning of the Gem Centre by the Cabinet Secretary for Mining										

Some money will be set aside for training gemstone cutters who will operate the machines. A Master Cutter will be sourced from India or Thailand to come and train cutters in Kenya. This will ensure that the Centre is manned by qualified personnel.

*G. Stakeholders*

The gemstone Centre will be fully run by the Government but will meet the needs of various stakeholders including

County Government of Taita Taveta, Gemstone Miners and Dealers, Universities and other learning Institutions, etc.

#### H. Operation of the Centre

The Centre will be financed and supported initially by the Government through Ministry of Mining but it is expected to be self-sustaining in the long run.

Value addition will be done by qualified cutters who will be given terms of engagement appointed Officer in charge of the Centre and the percentage of revenue to be retained by the Centre will be determined by a Board to be established.

The gemology laboratory will be run by the Government and qualified gemologist trained to operate it. Currently, the County Government of Taita Taveta has four people with Diploma in Gemology from Madagascar. These are potential candidates to work in the laboratory under supervision of a Senior Geologist or Gemologist.

#### I. Benefits from the Centre

The completion of the Centre is expected to set a new lease of life to the gemstone mining fraternity in Taita Taveta County and regionally.

The cutting of the different types of precious stones at the Centre will definitely add value to the stones before selling locally or exporting across the borders. Proper utilization of the Gemstone Centre will eradicate the present scenario where uncut gems are smuggled for further processing and export at higher returns to middlemen.

The Gem Centre will provide assistance to local Miners by adding value and providing ready market for them. It will enable the Government to gather data on its mineral endowment and assist in regulating this promising industry.

The Gemstone Centre is also set to become a regional precious stone business hub for the entire East African Region. It is hoped that the Centre will develop to International standards in near future.

In summary the establishment of a Gemstone Centre is set to spur economic growth through Minerals' value addition and will benefit all stakeholders in the gemstone industry in TaitaTaveta County and the Country at large.

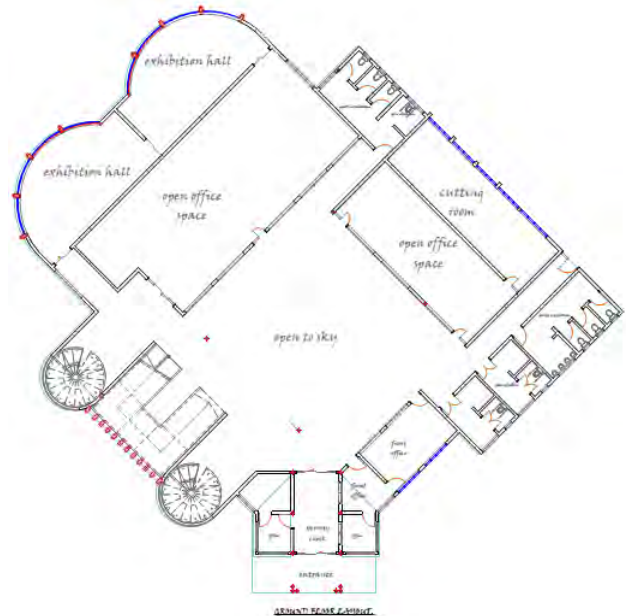

Figure 1: Ground Floor Plan of the Gem Centre



Figure 2: Second Floor design of the Gem Centre

### V. THE ASSESSMENT OF THE IMPACTS OF THE PROPOSED GEMSTONE CENTRE IN TAITATAVETA COUNTY BASED ON FIELD DATA

The data under consideration was collected during fieldwork and involved approximately 150 ASMs that were actively involved in mining. The respondents were asked to indicate their knowledge and understanding of the ASM sector and how it relates to their day-to-day livelihoods and socio-economic activities. The key area of interest to this study was to assess the challenges faced by miners and their recommended mitigation measures and how the proposed

gemstone centre will help resolve these. To get the feedback the respondents were asked to give their opinion along the following guidelines: experience, education level, market access, training needs, environment, contribution to household income and equipment requirement. The respondents were asked to rank in order of priority the importance of the foresaid areas and indicate how the proposed centre will enhance improved returns. Most of the respondents interviewed had worked as miners for a period ranging from 1 year to 46 years. Most respondents were in the 10 years bracket.

After assessing the status of ASM in Taita Taveta County a number of challenges emerged, key among them; the lack of equipment and related facilities, lack of food at mining sites, lack of water, insecurity, lack of geological skills and knowledge, exploitation and lack of better alternative market, lack of credit facilities and mining conflicts.

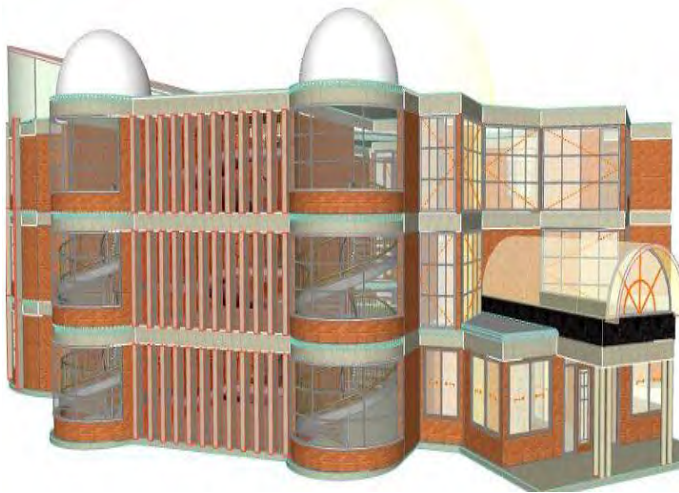

Figure 3: Full view of the Gemstone centre

#### A. Lack of Equipment

The major stumbling block to the success of ASMs in Taita Taveta County is lack of mining equipment as identified overwhelmingly by a majority of artisanal miners. Hence this issue has been isolated for attention. From field observation it was noted that due to the unique geology, and hence rock type, of the area the appropriate machinery need to be used to avoid redundancy. A good example was observed at the TimboKubwa building stone quarry near Taveta. An investor came with a building stone cutter commonly used to cut volcanic tuffs for building at Thika area (Thika Tuffs). This machine could not work here as the rock material at Taveta is harder than the Thika Tuffs. So the machine was abandoned and is now rusting away in the bush

According to field observation very few ASMs groups had received any equipment support except those in Mkuki and Kasigau ranches. Each of the two groups had received a compressor donated by the Taita Taveta County government. So, most respondents (95%) felt that the Gemstone Center will enable them to earn more from their mining activities and enable them to purchase their own equipments. As has been

highlighted in the preceding discussion the Gemstone Center will provide banking facilities that will use gemstones as collateral for loans. The Gemstone Center will provided miners with safes for depositing their gemstones; these will be used as security for loan facilities.

#### B. Lack of geological skills and knowledge

The study investigated whether the respondents had received any formal training relating to mining. Of interest to the study was the type of training undertaken by the miners in, geological prospecting, business, mineral identification, or Machine operation. There was also need to identify the institution of training. The respondents who had some basic training indicated they had been trained on basic gemmology and geology at TTUC.

Results revealed that 98.5% reported they had received no training while 1.5% received training on geology and gemology. Apparently no training has been conducted in business, mineral identification and machine operation, among others.

The respondents identified their preferred areas of training as follows:

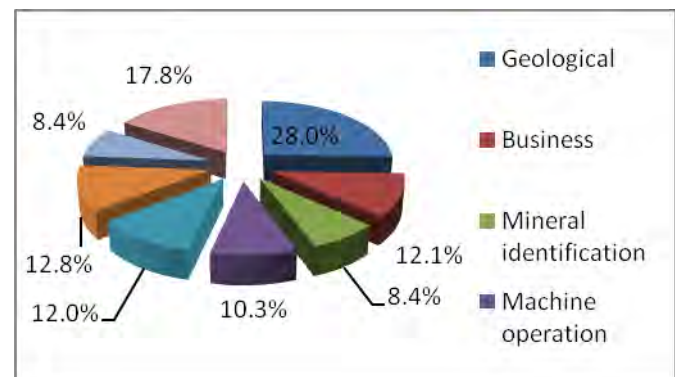

Figure 4: Preferred areas of training for ASMs, Source: raw field data

According to the findings, 28% of the respondents preferred to have training on geology, 18% opted to be trained in other areas (other includes Masonry, motor mechanics, agriculture, driving, carpentry, better sand harvesting methods, farming), 12.78% had preference for trainings in explosives and blasting, 12.14% preferred business, 12.03% preferred polishing and cutting, 10.28% preferred machine operation, 8.41% preferred gemstone and market access and 8.41% preferred being trained on mineral identification. An overwhelming (98%) majority of the respondent believe the Gemstone Center will provide all their training needs. Key among the objectives of the Gemstone Center is training. Because of its proximity to the miners this Gemstone Center will greatly enhance the capacity of miners.

### C. Exploitation by Gemstone Buyers

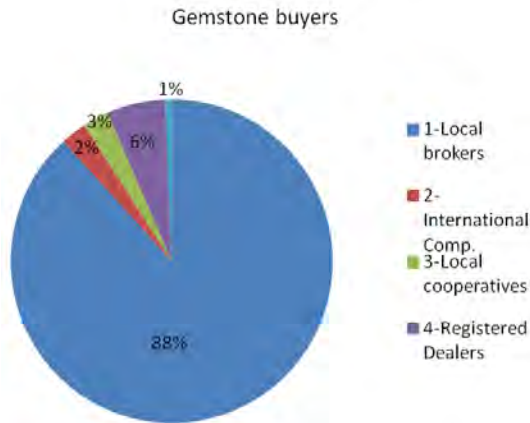

Figure 5: Gemstone buyers

From the pie chart below 92.9% of the respondents reported selling their gemstones to local brokers, 0.5% to international companies, 2.0% to local cooperatives, 4.1% to registered dealers and 0.5% to others. Most of the respondents expressed dissatisfaction with the local brokers who they felt were exploiting them due to their poverty and ignorance. In this regard the Gemstone Center was seen as a major development which will provide the ASMs direct and reliable market thereby eliminating the middlemen and brokers. Over 99% of the respondent welcomed the Gemstone Center and were very optimistic of its benefits and believed they'll not need to sell their rough gemstones to brokers

#### D. Miners' perception on return on value for their efforts

Table 4 represents proportion of constituencies that responded to this question

Differences were tested statistically with various indicators among constituencies at: ( $p < 0.01$  \*\*  $p < 0.05$  \*\*\*  $p < 0.001$ )

Table 4: Perception of value of effort based on constituency

Constituency	Is it worth the effort?		GC will improve income
	% Yes (N=15)	% No (N=162)	% Yes (N=162)
Taveta	54.3	80	98
Mwatate	35.8	20	96
Voi	9.9	0	99

\*Difference between the constituencies had no significant difference at p value of 0.13

Table 4 above, shows that Taveta constituency had more miners dissatisfied with return on invested effort (80%), while 54.3%, reported value for their effort. Most respondents from Voi reported satisfaction with mining as a source of income. Statistically there was no significant difference between the constituencies in terms of return on effort from mining. In general, a high percentage across the constituencies expressed dissatisfaction with return on effort from mining. However a substantial majority (98%) felt that the establishment of the

Gemstone Center will totally reverse the sense of dissatisfaction with their mining activities. Since the Gemstone Center will give direct access to market

#### E. Why miners are not satisfied with mining as the main source of income

The data reveals that 53 respondents were dissatisfied with mining as the main source of income. Among these 68% expressed dissatisfaction due to low income from mining activities, 11.3% due to unpredictable markets and lack of support from the authorities while 7.5% attributed their dissatisfaction to poor working conditions.

Proportion of lack of satisfaction based on constituency

Table 5: Reasons for dissatisfaction with mining

Constituency	Why I'm not satisfied				
	%Low income	%Unpredictable markets	%Poor working conditions	%Risk	%No support
No.	36	6	4	1	6
Taveta	84.6	3.8	7.7	0	3.8
Mwatate	33.3	27.8	11.1	5.6	22.2
Voi	88.9	0	0	0	11.1
Total	68	11.3	7.5	1.9	11.3

The Gemstone Center will help motivate the miners as they will realize more returns on investment and will put more efforts in production.

#### F. Gemstone Prices appreciation along the value chain

Table 6: Gemstone price variations (estimates)

Gemstone Prices in Kshs	Sale of Rough stone by ASMs	Sale price by brokers	Sale price by dealers	Price of final product (to customers)
Tourmaline(1Kg)	20,000	70,000	100,000	300,000
Tsavorite(1g).	50,000	300,000	500,000	1.5m
Blue Zoisite(1g)	35,000	100,000	300,000	500,000
Zoisite(1g)	2,000	6,000	20,000	100,000
Ruby(1g)	40,000	200,000	500,000	1m

From the change in prices along the value chain it's evident that common ASMs will benefit greatly by accessing competitive prices for their rough gemstones. This means there will be an exponential growth in income to ASMs and hence increased productivity.

## VI. CONCLUSION AND DISCUSSION

The introduction of this Gemstone Centre at the heart of a major gemstone region will be an historic event. This single move will transform the lives of the locals who depend on

mining for a living for ever. If managed properly the centre will change the face of Voi town as well as the entire Taita Taveta County. This centre will do to TTC what Coffee did to Kisii County in the 70s or what Mohoroni sugar factory did to famers in Kisumu County.

One of the key outcomes of the establishment of the centre will be the elimination of some key players currently controlling the market in the value chain. The local brokers stand to be the greatest losers in the new ball game. Equally affected will be the dealers whose international networks and connections have been their secret weapon. These two groups of players have been benefiting from the lack of geological and marketing knowledge on the part of ASMs so with the arrival of this centre their strategic advantage will be seriously weakened.

The demand for quality products and introduction of international best practice will improve and enhance gemstone cutting and polishing skills and craftsmanship besides increasing geological and gemological knowledge. The centre will provide facilities for training and research in gemology for the Taita Taveta University College's school of mining and engineering.

The centre will be having sections for safe keeping of the gemstones. This will provide the much needed security and hence reduce the robberies and other crimes related to gemstones.

## VII. RECOMMENDATIONS

For maximum returns on investment the following are the recommendations based on the field study and lessons from other countries:

1. The centre be managed as a parastatal to avoid the pitfalls associated with government run institutions such as the government chemist, Mines and Geology Department and Materials Laboratory to mention a few. Alternatively a public-private partnership format be adopted to avoid the inefficiencies and mismanagement in the public sector. The fore mentioned institutions or laboratories were set up with very well intended, ambitious and visionary motives but over time were run down due to poor management and corruption. The institutions often fail to offer critical services to the public due to lack of require chemicals or reagents. Expensive equipment are left in a state of disrepair for years, or the personnel manning the laboratories are not motivated and hence are inefficient or the lengthy bureaucratic procurement process holds decisions and work progress at ransom.
2. Give more emphasis on training of ASMs. This has been mentioned in the program but not much seems to be in the pipeline regarding training. It's suggested that a space be set aside for training and demonstrations only within the centre. This is urgent as observed from the field study. Top in the ASM wish list is a training to identify gemstones they come into contact with on their daily activities.
3. Establish a gemstone cottage industry to make use of discarded gemstone by-products. Along with this, build superior craftsmanship culture to make the quality of the

gemstone products from the area stand out in the international market.

## ACKNOWLEDGEMENTS

The information given in this paper formed part of a UNDP funded research-related fieldwork conducted in September-November 2014 in Taita Taveta County. The authors deeply appreciate the cooperation of the Ministry of Mining for providing non-confidential data that assisted in this study.

## REFERENCES

- [1]. Ministry of Mining, Mines and Geological Department internal reports – 2013.
- [2]. Kenya: Vision 2030. Government of the Republic of Kenya. Ministry of Planning and national Development. Office of the President, Nairobi, 2007.
- [3]. Bridges, C.R. (1974) Green grossularite garnets (tsavorites) in East Taita Taveta County (TTC). *Gems & Gemology*, Summer, pp. 290–295. Scale mining and sustainable development within the SADC Region.
- [4]. Pohl W. and Horke, A (1980) Notes on the Geology and Mineral Resources of the Mito Andei-Taita Area (Southern Kenya), Kenya Austria Mineral Exploration Project.
- [5]. Report on the gemology course for small scale miners in Taita Taveta County, Department of Mining and Mineral Process Engineering, Taita Taveta University College, 2011.
- [6]. Simonet, C., Okundi, S. and Masai, P. (2001) General setting of coloured gemstone deposits in the Mozambique Belt of Kenya—preliminary considerations. *Proc. 9th Conf. Geol. Soc. Kenya, Nairobi, November 2000*, pp. 123–138.
- [7]. Kenya: Vision 2030. Government of the Republic of Kenya. Ministry of Planning and national Development. Office of the President, Nairobi, 2007.
- [8]. Mwandawiro Mganga (2009): Mining in Taita Taveta County: Prospects & Problems
- [9]. Nyaberi, M.D. and Rop, B.K. (2014) Petroleum prospects of Lamu Basin, South-Eastern Kenya. *Journal of the Geological Society of India*, Volume 83, Issue 4, pp. 414-422.

# The Character and Profile of Artisanal and Small-Scale Gemstone Mining Community in Taita Taveta County, Kenya

Seroni Anyona and Bernard K. Rop

**Abstract**— This study focuses on the artisanal and small-scale gemstone mining community in TaitaTaveta County with the objective of assessing their demographic profile and how their lives have been affected by the mining activities. The County is endowed with a wide variety of some of the rarest gemstone in the world. These include the famous Tavorite, Ruby, Tourmaline and Sapphire, to mention just a few, which have attracted a substantial number of people both from within and without the county forming a unique community whose lifestyle is dictated by this economic activity. Understanding the characteristics of this community would be critical for policy makers, planners and other institutions or individuals interested in providing support or any interventions. The study was carried out in the field by visiting and interviewing approximately 150 Artisanal and Small-Scale Miners (ASMs) who were actively involved in gemstone mining, 20 local brokers and 10 key landlords. The respondents were asked to indicate their knowledge and understanding of the ASM sector and how it relates to their day-to-day lives and socio-economic activities. Some of the areas of interest to this study were: mining experience, marital status, education level, gender, market access, contribution to household income and equipment used. This paper discusses the analysis of data collected and makes recommendations. Most of the respondents interviewed had worked as miners for a period ranging from 1 year to 46 years.

**Keywords:** Artisanal miners, gemstone, socio-economic, respondents, data collection

## I. INTRODUCTION

In many parts of the world, artisanal or small-scale mining (ASM) activities are at least as important as large-scale mining activities, particularly in terms of the numbers of people employed. ASM can play a crucial role in poverty alleviation and rural development; most of those involved are poor and mining represents the most promising, if not the only, income opportunity available. However, the sector is perhaps better known for its high environmental costs and poor health and

safety record. Many continue to view it as dirty, unprofitable and fundamentally unsustainable [1,3, 30, 31].

Irrespective of one's perspective of whether or not the sector is a net contributor to sustainable development, the fact remains that small-scale and artisanal mining activities will continue for at least as long as poverty continues to necessitate them. It is therefore essential that effort be made to maximize the benefits brought and enabled by small-scale mining, and to mitigate the costs [30]

Understanding the socio-economic dynamics of any ASM community is the first step towards designing and implementing sustainable interventions.

The TaitaTaveta gemstone ASM community is a loose amalgamation of people from a wide spectrum of backgrounds gathered together for a common purpose. The key purpose is to eke a living from the gemstones. Their lives have been affected by the mining activity and the objective of this study is to paint a picture of this community depicting their interactions, way of life, perceptions and beliefs and how they have responded to the demands and challenges presented by dealing in gemstones.

### A. Study Area

This study was carried out between August and October 2014 by a team of professionals in TaitaTaveta County. The County lies in the south-western part of Kenya's coast. It is bounded between longitudes 37° 30' 00" and 39° 30' 00" East and latitudes 2° 30' 00" and 4° 30' 00" South. It is approximately 200 km northwest of Mombasa and 360 km southeast of Nairobi. It borders Makueni, Kitui and Tana River Counties to the North; Kilifi and Kwale counties to the east; Kajado County to the Northwest and the Republic of Tanzania to the Southwest

The county has an undulating and rugged terrain with an altitude ranging from 500 m to almost 2,300m above sea level with Vuria peak being the highest. The rainfall varies according to the terrain with the lower zones receiving an average 440 mm of rain per annum and the highland areas receiving up to 1900 mm of rain. The population of the county 30 years ago was approximately 45,000 persons but this has shot up to well over 284,657 persons (2009 census) with population densities ranging from 3 persons per km<sup>2</sup> to more than 800 persons per km<sup>2</sup>

The county covers an area of 17,083.9 km<sup>2</sup> (6,596.1 sq mi) of which a bulk 62% or 11,100 km<sup>2</sup> is within Tsavo East and Tsavo West National Parks. The remaining 5,876 km<sup>2</sup> is occupied by ranches, sisal estates, water bodies

Southern Eastern Kenya University, School of Earth Sciences, Institute of Mining and Mineral Processing Department of Geological Science P.O. Box 33542 – 00600, Nairobi, Kenya. (seroni20@yahoo.com)

Jomo Kenyatta University of Agriculture & Technology, Mining, Materials & Petroleum Engineering Department, P.O. Box 62000 – 00200, Nairobi, Kenya (e-mail: droppen@gmail.com).



such as Lakes Chala and Jipe in Taveta and Mzima springs, and the Hilltop forests which occupy less than 100 km<sup>2</sup> or approximately 10 km<sup>2</sup> out of 587.5 km<sup>2</sup>.

The lowland areas of the county that do not belong to national parks or ranches are divided into estates and wild life sanctuaries. The county has approximately 25 ranches. The main land use in ranches is cattle grazing. The three operating sisal estates of the district are the Teita Sisal Estate, Voi Sisal Estate and Taveta Sisal Estate. The ranches are also used for wildlife conservation and tourism. The famous Taita Hills and Saltlick Lodges sanctuary are located in the county.

The economic activities practiced in TTC by the local communities are livestock keeping, small-and large-scale mining, small-scale subsistence farming and small- and micro-enterprises and/or businesses. Some of the people are employed in various public and private institutions in the County.

In 2007, the then Taita-Taveta District was split into two districts: the Taita District and the Taveta District. The two were subsequently merged to form Taita-Taveta County. This consists of four constituencies namely, Voi, Mwatate, Wundanyi and Taveta. There are 20 county wards which include Mwanda/Mgange, Werugha, Wumingu/Kishushe, Wundanyi, Mwatate, Bura, Chawia, Wusi/Kishamba, Sagala, Kaloleni, Kasigau, Ngolia, Mahoo, Bomani, Mboghoni, Ronge, Mbololo, Marungu, Chala, and Mata.

### B. Economic Geology

Geological reports of surveys carried out at different times in this region show the presence of mineral deposits in the County and the neighboring areas. A report by Horkel (1980) shows that parts of Taita-Taveta County has high and middle value gemstones including: Tsavorite (green garnets), red garnets, ruby, change colour, blue sapphire, pink sapphire, green tourmalines, yellow tourmalines, rhodolites and kyanites [27]. The main gemstone mining area in Kenya is in the Tsavo region, which derived its name from tsavorite [2]. Many small mining operations are located along a fault system extending from the Taita Hills of Kenya to the Uмба Valley in northern Tanzania, passing through the Tsavo, Kasigau and Kuraze areas. This is where Campbell Bridges discovered tsavorite in 1971 and where his company continues to carry out mining. Taita-Taveta County is currently the main source of Tsavorite in the world.

Rubies are associated with ultramafic rocks while *greengrossularites* ("Tsavorite") is strata-bound. Other gemstones include *blue zoisite* ("Tanzanite"), *andradite*, *Red spinel*, *turquoise*, and *Amethyst*. The production of graphite, particularly from the Chawia deposit may also prove economically feasible. Less promising mineralization, mainly with a potential for domestic markets, are magnesite and asbestos occurrences in ultramafic bodies or kaolin and magnetite deposits. The development of bulk commodities such as marble and structural stone depends mainly on an adequate local market potential.

Marble is available for quarrying east of Mwatate on a small scale. Owing to a high Mg (Magnesium) content, the rock is not suited for the manufacturing of cement, but merely for burning to produce lime, and as dimension stone or

aggregate. Small quarries for basalt, gneiss and lapilli supply the local requirements for road metal and aggregate. Ample resources of these low-value bulk commodities are readily available for development if required by increased local demand. Building stones (tuffs) are currently being quarried near Taveta town and there is a potential for further expansion if more resources are invested and the demand is right. There is sufficient supply of sand to satisfy the needs of the area and even surplus to sell to the neighbouring counties.

Taita-Taveta County is therefore endowed with one of the richest minerals deposits in Kenya and the Eastern Africa region [15]. These include both industrial minerals and gemstones, which have the potential of generating considerable wealth to various mining prospectors and investors [1]. But this wealth does not trickle down to the local people. According to Mwandawiro (2011), this wealth continues to benefit middlemen, brokers and other players along the supply chain while poverty in the county continues to spread unabated. Furthermore, the mining is often carried out without clear government regulations and control [28]

### C. Definitions and General ASM Characteristics

Broadly speaking, artisanal and small-scale mining refers to mining by individuals, groups, families or cooperatives with minimal or no mechanization, often in the informal (illegal) sector of the market. Despite many attempts, a common definition of ASM has yet to be established. In some countries a distinction is made between 'artisanal mining' that is purely manual and on a very small scale, and 'small-scale mining' that is more mechanized and on a larger scale. This is the definition that is used in this paper i.e. artisanal miners are those without land allocation of their own and use purely manual mining methods and are largely illegal and informal. On the other hand, Small-scale miners are those with mining licenses and land allocation and carry out mechanized mining albeit to a small scale considered legal and formal.



Figure 1 Miner picking gemstone from a mineral pod

Artisanal mining may be better characterized by a lack of long-term mine planning and use of rudimentary techniques [10, 11]. These artisanal miners employ rudimentary techniques for mineral extraction and often operate under hazardous, labor-intensive, highly disorganized and illegal conditions. Despite these factors, artisanal mining is an essential activity in many developing countries, particularly in regions where economic alternatives are critically limited. The International Labor Organization [13] estimates that the number of artisanal miners, in the world, is currently around 13 million in 55 countries. This figure is roughly equivalent to the global workforce of large-scale mining. From this, it has been extrapolated that 80 to 100 million people worldwide are directly and indirectly dependent on this activity for their livelihood.

Approximately 30% of the world's artisanal miners are women and youth who occupy a number of roles ranging from labour-intensive mining methods to the processing aspect of artisanal mining. In many cases, the roles of women and youth in artisanal mining communities differ significantly from those of men, and extend well beyond direct participation in mining activities that are often overlooked by initiatives and development programmes directed at catalyzing the transformation of artisanal mining. Due to their critical role, not only in mineral production, but also in the development of sustainable communities, combined with their susceptibility to poverty, enhancing the role of women in artisanal mining may be a means to "bridge the gap" between the well- conceived technical and socio-economic changes often prescribed for artisanal mining, and the actual facilitation of positive transformation of the artisanal mining sector. This may be

accomplished in a number of ways, such as Gender-sensitive technology assistance initiatives – *Gender* [3] refers to the behaviors, attitudes, values, beliefs, etc. that a particular socio-cultural group considers appropriate for males and females.

#### D. The Relevance of the Study

Most of the research and publications done regarding the gemstone sector in TaitaTaveta County address the natural science and geological issues, since they are driven by prospector, investor and trade interests. Consequently, little has been published about the, social-economic dynamics and how mining activity has influenced the lifestyle of the mining community and the general populace of Taita Taveta County (TTC).

This calls for a focused in depth research to profile and evaluate how the demands and challenges posed by gemstone mining have dictated the social setting, communal organization and family stability of ASMs in the study area. Critical here is the need to include the relationship between the people of the mining areas affected, the environment and the mineral resources. Such research would also need to explore more cogently why local people continue to be losers in the exploitation of the mineral resources in their ancestral lands, and what should be done to correct this in order to promote sustainable development. Given that Taita-Taveta County is endowed with abundant minerals it was important to find out how the social fabric of the local people has been affected by the influx of a none-native population and the resulting community.

It is also important to determine the benefits accruing from an industry that is reputed to make billions of shillings in profits annually, and whether the profits made from the sector trickle down to the community and whether benefit sharing between the investors, communities and government, are comparable to international best-practices. This information would prove invaluable to agencies, donor community, individuals and governmental institutions interested in planning, designing and implementing interventions focused on ASMs in TTC

## II. PROFILING THE ASMS

Most artisanal mining in TaitaTaveta is rudimentary in nature; the miners mainly use easily available explosives to break down the rocks in search of gemstones and precious metals. The health and environmental risks are enormous. Besides these issues, the markets for gemstones are not well established – a few dealers and brokers still control the entire process; the small-scale artisanal miners in TaitaTaveta have limited market powers. It has been reported that there is a big black market for gemstones. The miners also lack the technical knowhow, capacity, to correctly value the gemstones.

The artisanal miners are predominantly men with little or no education. They have little or no income but big expectations. Almost all interviewed artisanal miners expressed very high optimism that they will one day strike it rich. They have undivided attention to their work and would never consider abandoning it. They have an obsession for their work that

keeps them going even under very hostile conditions. This is almost like a fanatical commitment.

Artisanal mining typically uses manual labour, simple tools, and basic recovery and processing techniques. Small-scale mining is also labour-intensive but also employs a higher level of mechanization and more sophisticated processes.

ASM is frequently migratory as miners move from site to site in search of minerals. The rate at which they move, and the area within which they travel, are functions of a combination of practical, economic and social factors including the life of the mine; the lure of high value mineral strikes in other areas which create a 'rush' to that site; relocation by traders; pressure from conflicts; exclusion from a site by new restrictions such as the arrival of a large-scale mining company; rain and the availability of water; environmental shocks; and the agricultural seasons.



Figure 2 ASMs at Mkuku area

A number of them do not have land of their own so they often carry out mining 'illegally' in ranches and other privately owned land or in the neighbouring Tsavo national park. They are commonly referred to as "Zururas" meaning marauding miners or 'miners without borders'. However a significant number of them have now formed associations or cooperatives and have staked claim on some ranches. They however lack the necessary land ownership documentation such as title deeds, and this has been the main source of the mining conflicts in the area.

Due to lack of financial capital, most artisanal miners, work under some 'land lord' who supplies them with the much needed food, water and shelter and whatever mineral they recover is shared out with the land lord taking the lion's share. The desperate circumstances they work under expose their vulnerabilities making them easy target for exploitation by predatory middlemen or brokers. From the field interviews it would appear that it takes so long to get gemstones of economic value. A number of them cannot recall recovering any valuable gem in the last six months to one year. However it is said that when they get good quality gemstones and make significant amounts of money, they indulge in excessive leisure, drinking, taking foreign trips abroad and purchasing lavish cars and would only return when the money is exhausted – then the cycle repeats itself again.

The trade is fraught with dangerous and illegal practices, and, it can have serious implications for security. It can create localized and far-reaching social risks, and typically exploits highly vulnerable individuals and groups.

There are few small-scale miners who have made good money from the industry and established themselves well. These often have land of their own with title deeds and practice mechanized mining with a good network of clients locally and internationally. They have invested their income elsewhere especially in real estate in major or nearby towns like Voi and Mwatate and they often act as landlords or brokers to the artisanal miners. With their enhanced capital base coupled with their understanding of the area, this category of small-scale miners, stand out to be the greatest beneficiaries of the mining industry in this area.



Figure 3 Open mine pit at Mkuku area

There is however a different category of artisanal miners in the area; those involved in building stone quarrying and sand harvesting. The former group is found near Taveta town and the later at Ongoni area along the Voi River (and other rivers in the area). Unlike gemstone miners these ones operate from their homes and are less optimistic about the future and are less secretive in their dealings. They also assist the county government in collecting cess from Lorries that come to collect building stones. Fewer conflicts have been reported from this type of miners compared with those from gemstones though they have less income. These often use mining as a supplementary source income apart from farming, which also promotes seasonal work patterns.

Small-scale mineral producers form the majority of mineral dealers in Taita-Taveta. These small-scale miners can be categorized according to the size of mining area, number of people employed or involved and volume of production and profits they make. They use simpler, fewer and less sophisticated tools and machines. Most of them are self-employed and work in groups of four - eight, comprising relatives or neighbours. For example, in a group of ten small-scale miners, only three hire labourers. Most small-scale mineral producers depend on their own labour. They sell their minerals locally. Traders travel to buy gemstones from small-scale miners at Mkuku, Kasigau, Kamtonga, Chungaunga,

Bura, Kishushe and Wanjala. However, a few small-scale mineral producers sell their gemstones as far away as Mombasa, Nairobi and Arusha while a few have access to market outside the country.

The small-scale miners rarely access loans to invest in mining as most of them do not meet the legal requirements for mining. Whenever they discover the minerals, they are often dispossessed of the claims by the large scale-miners who employ or chase them away. They are also often exploited by brokers and the large-scale miners as they rarely know the value of their gemstones and have little access to the gemstone markets controlled by large-scale dealers.

There is some symbiotic relationship between the large- and small-scale miners. Some large-scale mineral producers support small-scale miners with water, transport, food, security, and other requirements. In return, small-scale producers sell their gemstones to large-scale miners as well as provide them with relevant information on minerals potential of the area.

#### A. Zururas'

Some producers and sellers of gemstones do not fit in the various categories of small-scale miners. They are simply known locally as zururas; a nickname for mines and mineral dealers with no legal mining rights. They are mainly poor people from all over Kenya and the neighbouring countries who operate in the plains of TaitaTaveta County and depend on gemstones for survival. They live and struggle to earn livelihoods where the rich and powerful have privatized nearly all the land that is rich in minerals.

The zururas come from virtually all the ethnic groups of Kenya – especially Kikuyu, Embu, Meru, Tharaka, Maasai, Somali, Kamba, Taita, Luo, Luhya, Giriama. Some from outside Kenya belong to the Chagga and Pare tribes of Tanzania. They roam the mining areas in Taita, scavenging for gemstones which they sell for a living. Many of them are vagabonds, being criminals who have escaped from prisons or justice systems to seek refuge in the wilderness of Taita-Taveta County. They hide in the mining areas and hardly leave the place, except for a short time at Mwatate and Voi to sell their gemstones. Some zururas are former employees of the mines who decided to continue living around the mining areas to scavenge for gemstones [34].

During the stakeholders' workshop the term ZURURAS generated a lot of controversy and divided participants. Some

participants felt that it was derogatory term and casts a negative image on otherwise genuine miners who have in a number of instances spearheaded the discovery of rich gemstone deposits.

On the others hand a substantial majority of them felt that we cannot escape the fact that Zururas exist and they have created a cartel that has no respect for private property nor the rule of law.



Figure 4 Tsavolite Mining Co. Ltd site at Kasigau Ranch, Tsavo West Park

#### B. Other Producers and Dealers of Gemstones

Many other people in Taita are involved in the production of minerals and gemstones in some way. These include herders who discover gemstones, collect them and sell them to dealers. Teachers, policemen and other business persons in Wundanyi, Mwatate, Voi, Bura, Maungu, Kasigau and other places of TaitaTaveta County are also involved. But their involvement in the industry is mainly illegal. They work in mining activities to supplement their incomes. In fact, many civil servants, including district commissioners and district officers engage in gemstones production and trade whenever they are posted to work in TaitaTaveta County. Some even become small-scale miners. This happens despite fact that the law forbids it.

Some are brokers (middlemen) of minerals of all sorts at Voi, Mwatate, Kamtonga, Kasigau and in mining areas, as well as Nairobi, Mombasa and Arusha. They sponsor small-scale mineral producers or 'zururas' with food, water and tools on condition that the gemstones produced are only sold to them, yet some are peasants who own land which has gemstones and who lease their land to people with prospecting rights (PRs). Others are large land owners who have minerals deposits in their land. They include hotels, sisal estates and private farms. They secretly produce gemstones in their large properties.

### III. MATERIALS AND STUDY METHODS

The study materials and data were gathered between September-October 2014, during an eight-day field period in the county. The empirical materials consisted of RPA (Rapid Rural Appraisal) and in-depth interviews, unstructured interviews, questionnaires and desk references, literature review of existing information, reports, journals and field observations as well as review of relevant Kenyan laws on mining. The field studies began by an excursion as part of the RRA. The interviews were carried out by the team of professionals. The study mainly focused on the areas where



Figure 5 Interviewing miners on site Mkuki area

mining is taking place. These included Chawia area, Mwatate, Kasigau, Alia, Kishushe, Mkuki, Buguta, Ongoni (Voi River), Bura, Taveta and Wundanyi.

The RRA is based on the idea that data is bound to the time and place and that, therefore, no intentions are made to generalize it. Rapid refers to rapid data collection; getting results does not require time-consuming inputs and analysis of questionnaire data since the data is gathered through more informal and small-scale discussions [17]. This method emphasizes the importance of genuine participation of the local people, not only for the benefit of researchers but also for the benefit of the locals themselves who were given the opportunity to control, analyze and use the information to determine their destiny. The RRA method is highly recommended by many researchers especially in development cooperation [18] Information derived from this study was gathered by expert interviews, more unofficial unstructured interviews (representing RRA-approach) and questionnaires, of which the target groups were the administrative officers of Taita Taveta County, established miners and mining companies as well as the local civil society and whistle blowers.

In addition to these interviews, the team held several informal discussions, or unstructured theme interviews of which the

most valuable took place with the TaitaTaveta County governor H.E Mr Mruttu, some members of the county assembly, mining committee especially the chairman Mr.Mwangola, experienced and long serving miners, brokers and opinion leaders. The Principal of TTUC Prof Boga and Chairman of Mining and Mineral Processing Engineering department TTUC Mr.Ndegwa added value to the study since the institution has been involved in providing solutions to the mining industry. The current government regional geologist, Mr.Omito, provided critical information and guided the research team in field excursions. The team also worked closely with the acting County Executive Committee (CEC) Member in-charge of the Ministry of Mining, Environment, Wildlife and Natural Resources, Ms. Pamela whose input and information regarding the industry was invaluable. The questions were open-ended to elicit broad insights from the respondents on the extractive industry in the county, the activities of their organizations, the challenges faced and their recommendations. The questionnaire used is annexed to this report.

In total, over 150 artisanal miners were interviewed, 20 local brokers and 10 key small scale miners namely; Musa G. Njagi, Gabriel Mcharo, Miceni Musa, Edith Lewela, Joseph Mtwandei, Major Mtongolo, Jared Nzano, David to mention just a few, were also interviewed in-depth.

#### *A. Sampling Technique*

The sampling method used for research should ensure that the selected subset is representative of the population in order to increase reliability and validity [35]. This study attempted to use both probability sampling and non-probability sampling during selection of the artisanal and small-scale miners as well as brokers and other stakeholders.

The study involved both quantitative and qualitative methods. However, more emphasis was put on qualitative field data collection. The aim was to generate living data on mining in Taita-Taveta by interviewing the stakeholders in the mining industry in the area.

The past media coverage of the mining activities in TaitaTaveta County and the associated political dynamics were also examined to highlight the socio-political nature of the industry and the ensuing conflicts.

This study used a two-tier sampling method including the random sampling and simple random sampling. Simple Random sampling essentially gives equal chance of selection to all items or persons in a population [36]. This method is fair and gives all sampling units an equal opportunity of being selected. Additionally, a simple random sampling method allows researchers to draw inferences and generalize the findings of the study.

#### *B. Stakeholders' Workshop*

After the completion and compilation of the field study a stakeholders' workshop was held to disseminate the study findings and receive feedback from the participants. The mining communities were represented by different groups and/or individuals involved in mining.

#### *C. Numbers of ASM Workers and Dependents*



Figure 6 Interview with miners

It is notoriously difficult to collect accurate information on this sector given its informal and unregulated nature, seasonality, migration, use of ASM as a supplementary or back-up income source, etc. However, it is generally agreed that ASM is growing and this is an invisible income generating activity.

According to the national government's records there are 512 recognized mining allocations most of which are licensed and two operating on government leases namely Bridges Exploration Ltd and Rockland (K) Ltd. Of the 512 licensed miners a number of them are out of operation due to various reasons ranging from attrition, financial problems, conflicts and other personal problems.

Apart from government records we were able to get lists of members of a number of mining associations and self-help groups (see table below). The estimated the number of dependants can be computed by using the 2009 population and household census which gave an average of 6 persons per household. Assuming each member of the associations identified below represents one household and that each has children, then the number of dependants can be estimated by multiplying the number of members by six.

Table 1 Number of people directly and indirectly dependent on mining

No.	Name of Association/Co.	Est. No. of Members	Est. No. of dependants(times 6)
1	Mkuki Mine	140	840
2	TaitaTaveta Women Mining Group-Alia	300	1,800
3	MuonganoGwaloli Mining Group-Buguta	150	900
4	TimboMlimani	400	2,400
5	TimboKubwa	150	900
6	Lukundo Mine	100	600
7	Alia Mining C.G	234	1,404
8	Licensed miners	512	2046
9	Rockland (K) Ltd	41	246
10	Bridges Exploration	6	36
11	Tsavolite Mine	41	246
12	Ongoni area-Voi River(sand)	50	300
13	Wanjala Mining-Kishushe	600	3,600
14	Mama Mercy Miners	200	1,200
15	Others	300	1,800
	<b>Total</b>	<b>2,684</b>	<b>19,344</b>

This is a very rough estimation which excludes miners that do not belong to any association and operates on many assumptions. But even going by this alone, one can get an impression of the sheer size of people who directly or indirectly depend on this industry. This is considered an underestimation and therefore a much larger number of people are supported by the extractive industry in this area.

#### IV. SOCIAL IMPACTS OF ASM

ASM can have significant negative social impacts as an influx of miners to an area can cause overcrowding, contamination, and consumption of the area's water and other resources, as well as introducing or escalating alcohol abuse and sex-trading. ASM can change an area's economic profile dramatically bringing new revenue sources, stimulating trade, and creating access to new goods and services, but often at the expense of traditional income sources and with associated inflation.

Key mining town centres such as Mwatate and Kasigau have experienced major transformations in the last two or so years as the number of artisanal miners keeps increasing. Changes in the moral fabric of the towns have been witnessed with an evident increase in alcoholism and sex-trade. Business owners however are happy with the increased sales and money circulation in the local economy fueled by the new guests. Real estate owners have also hiked their rents and more people are investing in house construction which also comes with economic ripple effects.

Conflicts over land and mineral resources are commonplace in Kasigau, Chungaunga, Kamtonga, Mwachabo, Alia, Kishushe and other parts of Taita - especially in the lower zones where mining is a major economic activity. Wealthy and politically-connected individuals, mainly from outside of the county, have a stranglehold on the industry; they acquire the right to prospect for minerals in the area from the administrative centres of Nairobi, Mombasa and the area district headquarters at Wundanyi often without the participation of the local communities [19].

Conflicts between small-scale gemstone miners and large-scale gemstone miners arise because most of the land in the lower zones of Taita-Taveta County is not demarcated; the general feeling is that the locals have been robbed of their land and resources.

##### A. Political Impacts of ASM

Mining being one of the main income generating activities in TaitaTaveta County, is bound to attract a fair share of political attention. While political intervention is inevitable and could positively impact the extractive industry by focusing attention on the plight of the artisanal miners, most of it has been negative, divisive and to some extent selfish. Exploiting the dire and deplorable state of the artisanal miners for political expedience is common and may not be unique to this area. Targeting non-locals for blame as contributors to the poor state of the local community can be appealing to the voters and may offer temporary politically mileage but it cannot provide a lasting solution to alleviate poverty among the electorate. What it may succeed to do however is to create a feeling of distaste for non-locals and generate conflict.

This is currently developing in the area and people generally feel that the poor small-scale miners labor for many months and years to prospect for the minerals; but they are often violently evicted from the mines by powerful and well-connected large-scale prospectors, miners and traders who claim legal ownership of the land as soon as the locals

discover mineral deposits. Residents around mining areas complain of human rights violations by the police and the rich and powerful miners. Their complaints include cases of arbitrary arrests, torture, imprisonment, and even murder. These have been reported mainly in Kishushe, Mwachabo, Chungaunga, Kamtonga, Kasigau and throughout the other mining

### *B. Issues Appearing in the Kenyan Print Media regarding ASM in Taita Taveta County*

To help put the issue of ASMs in Taita Taveta in context, it was thought necessary to review the relevant matters appearing in the local print media. A number of past newspapers were reviewed and emerging concerns were summarized.

- Mining in Taita Taveta County started in 1970 and so far 483 industrial minerals and 197 semi-precious minerals have been discovered.
- The most common issue appearing in the media since the year 2002 is the conflict between miners over land and minerals. It is reported in a number of occasions that some Small-scale Miners (SSM) carry out mining without seeking consent from locals. Conflicts have been reported at Mkuki mines where at one time (2006) two groups clashed over ownership. In the year 2009, a private miner at Mkuki, Lukas Kitumbi (Chawia Garnet) had his daughter killed and wife injured by thugs and gemstones worthy millions of shillings were stolen. In May 2006 a confrontation erupted at Mgama hills between squatters seeking to encroach on private land of about 28,000 acres. SSMs, being issued with exclusive prospecting license illegally and excluding locals from the vast idle mining fields.
- The other frequent issue that has been appearing on print media is the politics of minerals and mining. Sometime around 2004 the then Voi Member of Parliament led three thousand demonstrators to protest against poor management of ASM and mining issues in general. They wanted the District Commissioner (DC) transferred for failure to address the problems of wealthy investors in the mining industry oppressing locals. Days later, 45 out of 70 ASMs from Chungaunga were arrested while trying to invade Davis Mining and were released without being charged.
- Then around 2008 the former Voi MP Basil Mwakiringo lamented that the government was registering behind doors companies belonging to Kamlesh Pattni and Gideon Moi to mine in Tsavo National Park. He wondered why the government had allowed some companies to

prospect and mine in the National Park while denying others.

- In 2009, Mwatate MP Calsit Mwatela blamed the provincial administration and geological department for taking sides and suggested that mine owners issue their workers with badges to help screen out criminals and the government to increase police posts in the mining areas.
- Around 2002 the then Mwatate MP Hon. Madoka wanted to know what the government was doing to regulate prospecting and mining. He felt that Kshs 250M received as royalties from mining activities in 5 years was too little and wanted better monitoring of the industry. Chamber of commerce and industry chairman, Kimuzi Mjomba recommended that a mines office be set up in the area.
- The issue of brutal killings also attracted media attention. In 2009 three gemstone miners were killed and 10 injured. The same year there were more reports of killings some of which were ritual – some miners are reported to rape mentally handicapped women in the hope of getting good luck when they go mining. August 2009 the Chairman of Kenya Chamber of mines – Campbell Bridges was murdered.
- The fact that the area has great wealth but the local people are poor has been a matter of concern to all, the media included. The gemstones from Taita Taveta are the second largest income earner in the county – Kshs.500M earned from the industry for the last 6 years. Gemstone exports accounted for Kshs5B (out of 11 billion nationally) compared to gold (Kshs 3.5B) and Kshs7.5B from soda ash. In 2003 the country earned Kshs 8B from the gemstone industry and ASMs contributed about 80% of this. In 2003, 6g of cut and polished gemstone could fetch Kshs. 270,000 while the raw gem would fetch Kshs 15,000. However roads leading to these multi-million mining sites are in a deplorable state and there is lack of clean water. Locals always complain about poor facilities in the area despite the area having vast resources and miners claim that they are being exploited by mine owners. Nine people died due to mine-related accidents, two buried alive at Mwatate – 1 stepped on an explosive at Kasigau.
- Some local leaders have been calling for sobriety in the area: Edith Lewela (TT SSM cooperative secretary) said the area would lose investors if illegal mining by gangs is not stopped. Some

sources claimed that investors from Thailand had shelved plans to invest in the area due to illegal mining.

### *C. ASM and Government*

It is certain that artisanal mining contributes extensively to the economy of a country. As a source of wealth creation, ASM has led to job creation, abating poverty and in some instances complementing other economic activities such as farming. This ensures that a family has multiple sources of income that when combined are able to sustain livelihoods.

As stated earlier, ASM is informal and the activity is termed “illegal” as most of the individuals or groups do not have the necessary permits or licenses which allow them to conduct mining operations. The activity involves the use of rudimentary tools or if mechanized, only to a small degree translating to low production that cannot be equated to the energy input. This then culminates into subsistence commercial gains that only add a small value in the lives of the miners.

In many countries, including Kenya, ASM has not been accorded its due share of attention due to its informal nature. It is therefore not integrated and thus not among the country’s major economic activities. ASM may be marginalized economically compared to the formal mining sector but it is by no means marginal in human and environmental terms [15]. A wide range of challenges can be attributed to ASM, key among them, is the negative impacts of ASM. Environmental degradation, effect on biodiversity, uneconomical mining practices as well as health and safety concerns are some of the issues that paint a bad picture to ASM. Other challenges experienced in ASM are that of legislative, organizational and social nature.

Artisanal mining is less environmentally sustainable when compared to other formal forms of mining. The reason for this is that inadequate economic profits are not generated to compensate for environmental degradation and the depletion of the mineral resources [30, 33].

The government has lost a considerable amount of revenue associated with ASM due to the existence of a black market. This is as a result of government’s inability to properly regulate the sector, complicated procedures required in marketing and sales arrangements and high tax rates imposed on the mining activities. This makes the black market the only available alternative. Presence of a black market indicates that a particular country’s government is not in control and therefore investors (mostly foreign) are discouraged from investing in such a country. This hinders economic development on a macro level as it only benefits a few players whose agenda is limited in the perspective of public interest.

Sub-economical mining which means extraction is limited to the equipment available, manages to extract the minerals that are accessible leaving those at specific depth, a consequence of artisanal mining. Proper mining practice dictates mining both the low grade and high grade to achieve the cut-off grade as demanded by the prevailing market conditions. This is however not the objective in the mining plan of ASM as the better grade you mine the higher the economic returns. The government’s involvement in ASM,

through financing, can aid in the acquisition of proper equipment to boost or lobby for economic mining.

Unregulated artisanal mining has led to failure in observing high health and safety standards. Although artisanal miners understand that their activities can affect their health, they still don’t know to what degree. Many have developed health complications after being exposed to toxic substances or due to inhaling materials considered harmful to their respiratory system. Accidental injuries are common in ASM and in extreme cases deaths have been reported. Most of the mines are not properly ventilated and stability of the mines is usually in question as the roof supports are usually not adequate. Instability in mines (roof caving) and poor or lack of proper ventilation may lead to deaths in artisanal gemstone mining areas in TaitaTaveta County.

### *D. Character of Mining Groups and the Role of Government*

As mentioned earlier, the ASM sector in Taita-Taveta County has been a mystery and at the mercy of cartels and well-connected individuals who have quietly benefited from the enormous wealth that is associated with gemstones. For this reason, very few artisanal miners were involved and only until recently with the opening up of the sector have mining groups and CBOs come up. Mining groups mainly include several individuals who mine under a common consent that is issued to the group. There usually exists a leadership structure which helps to govern the group’s day to day operations. Community based organizations (CBOs) have also of late been formed that are involved in gemstone mining. These organizations are registered with the social services department and are recognized as entities by the government.

Most of the CBOs involved in mining usually consist of individual artisans who also mine under a common consent acquired by the CBO. The CBO also assists the miners in acquiring equipment such as compressors which can come in the form of aid from the county Government and in return the miners’ part with a percentage of the total revenue from any sales they make which goes to the CBO. These groups and CBOs provide a good platform through which the authorities can reach them and provide financial and technical assistance even though the County Government has been doing little to assist. There was also at some point a small-scale miners co-operative which was started in 2005 (Taita-Taveta small-scale miners co-operative) and acted as an umbrella body for small-scale miners to front the collective agenda. However, the co-operative did not last for long as political influence and internal bickering led to its disintegration.

Co-operative structures have had limited success within ASM in this county as profit-sharing is not popular in the extraction of precious metals and stones. However, where associations are established for legal compliance and to improve access to other resources, they may have greater impact. Interventions which improve product valuation skills and knowledge, marketing skills and access to new markets through technology, ASM bourses, auctions, etc, can also improve ASM as a livelihood.



### *E. Relationship between Artisanal Miners and Small-scale Miners*

Any given ore body has its own unique mode of formation and occurrence and this will in turn dictate how its extraction will be carried out. The characterization of the ore body (i.e. its location, depth, extent, grade, quality and quantity) plays a big role in determining how the ore body will be mined and as such, there is a role for all scales of extraction. Artisanal and small-scale mining are all appropriate approaches depending on the location, volume and value of the resource. Gemstones as minerals also have their unique mode of formation and occurrence. In most cases, gemstones occur in concentrated forms that are not extensive and as such would warrant very careful extraction techniques to be employed.

Artisanal miners have been able to survive in the gemstone mining sector by virtue of the fact that they can easily prospect for a potential reef and dig along it and find whichever stone and in doing so using the most basic of tools. This way, the artisans are able with a minimum of capital investment, albeit with maximum physical effort, to still find gemstones which they can sell at a price that represents sufficient compensation for their effort. Small-scale miners are able to put in some degree of mechanization into the extraction process and at the same time employ several people to carry out the mining operations.

In the Gemstone sector in Taita-Taveta County, these small-scale miners represent the scale at which there is sufficient financial muscle and influence and they are the ones that hold the largest land consents and licenses. Only small areas within these consents are of interest to the miners with most of this land remaining idle yet there may be small but significant deposits of commercial value that could be efficiently exploited by artisanal miners using manual labour. With increased interest and presence of artisanal miners in gemstone mining areas, land is beginning to unfold as a major issue which will have to be addressed if a sustainable gemstone mining sector is to be established in the county. Land conflicts can prove to be a major stumbling block if not resolved and avenues will have to be established to see how best the artisanal and small scale-miners can co-exist so as to ensure gains from the sector contribute significantly to the socio-economic development of the area.

The conflicts arising from land can be solved by small-scale and artisanal miners entering into agreement to share land under consent which is currently idle but has some potential for gemstones. This has been the major source of conflict in the area, together with other factors, and has led mostly to the locals encroaching on consented land which they feel they are entitled to but cannot access it. And since most of the authority governing mineral extraction in the county is vested in the central government, it plays a major role in solving conflicts and land issues as regards to gemstone mining. Land, especially in mining areas, has and will continue to be a delicate matter that requires an all-inclusive approach. There has to be the political will from both the County and National government that shows a genuine concern and intention to solve this matter and make it possible for any person willing and able to engage in gemstone mining to do so. This will go a long way in ensuring that all stakeholders in the sector (i.e. the

National and County government, Small-scale and Artisanal miners, among others) benefit from this resource.

### **V. ASM METHODS, PROCESSING AND PROMOTION OF VALUE ADDITION**

Artisanal and small-scale mining is carried out in many different ways depending on tradition, geology, geography, the nature of the minerals, and available resources. Prospecting and exploration are usually done in the most basic manner and uses a mix of tradition, opportunism, rumours, observation and luck, all these techniques being refined and perfected over a period of time. The main indicator of presence of mineralization is alluvial deposits which the miners first dig up and then follow underground.

Over time, artisanal miners have developed an understanding of the local geological formations in which these gemstones



Figure 7 Taita Taveta County Governor HE Eng. John Mruttu addresses miners in seminar

occur and this has acted as their guiding principle in the prospecting and digging operations. Very few if any, mostly small-scale miners with access to geological information, employ the use of formal prospecting in their mines. Lack of information and therefore a lack of in-depth understanding of the geology of these gemstone mining areas hinder the efficiency of mining as most operations essentially amount to trial and error, wasting a lot of time, effort and resource.

Mining operation of any ore body can either be underground or surface, and it ranges from manual to mechanize. Gemstone mining also follows this trend, most of it beginning from alluvial deposits on the surface and then advancing underground depending on the mineralization. Alluvial deposits of gemstones were a common occurrence in the early days (60's, 70's, 80's) when the sector was budding with only a few people involved, but with more and more players coming into the picture, it is very rare to find alluvial gemstones these days. Most gem mining is done underground at present with mineralization tending to occur deeper and deeper in the ground as near surface deposits become exhausted.

Mining of these deposits is a tedious undertaking given the effort required to break rock and primarily involves the use of hammers, chisels, shovels and buckets and in some advanced



Figure 8 Kamtonga shopping centre - miners' town

cases drills, compressors, explosives and excavators. Artisanal miners usually apply the most basic of techniques to laboriously dig up box-cuts then tunnels underground as they follow mineralized reefs/zones.

Loose soil normally forms the overburden but this soon turns to hard host rock which requires immense effort to dig through. This is done manually using hammers and chisels, pneumatic rock drills and aided in some cases by prior blasting to loosen the rock. Tunnels dug out in this manner in some instances go more than 50 meters underground, with diameters large enough to allow crawling or crouching as one goes in. Adequate space is, however, provided at the work front to allow for digging and movement of material. Waste rock is usually removed manually using shovels and buckets or sacks but as the tunnel gets deeper, removing waste becomes a tedious task; with most miners preferring to spread it on the tunnel floor or collecting it in one area.

Small-scale miners employ more or less the same method of mining, the only difference being that they are able to employ machinery such as excavators, generators, water pumps etc. This enables them to mine in a relatively more planned and structured manner as compared to artisanal miners owing to more information, better prospecting and a larger pool of resources. In both cases, support of the mined out areas is not of much concern to the miners as they deem the host rock to be competent enough to support itself, though few pay attention to the fact that it is dangerous especially during the rains.

Most of the gemstones once mined, usually do not undergo any form of processing or treatment. They are just separated from the surrounding rock which they are normally associated with and thereafter sold as just raw or uncut stones to brokers who frequent mine sites, or in nearby towns of Mwatate and Voi. However, few brokers or experienced artisanal miners attempt to add value to the gemstones. A simple process may involve: separation (sorting after extracting the gemstone) this is done by hand, washing (using water) and shining (using glycerine).

#### A. Value chain for gemstones

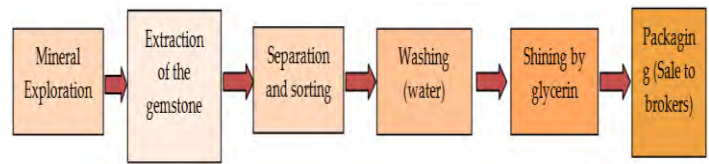

#### B. Access to Finance and Credit

Artisanal miners account for a larger percentage of the populace involved in the extractive industry in TaitaTaveta County as compared to those in small scale mining (Financially able to support themselves), which in our case is relatively considered to an extent, as large scale mining

Lack of proper capital base has culminated in ASM lagging behind in terms of sustainable development. There has to be a long-term financing that is efficient from the prospecting and exploration stage right through to the closure and reclamation of the mines. Access to capital is a major stumbling block affecting most of the ASMs in TaitaTaveta County as this was highly evident from the fieldwork conducted. Prospecting, exploration and other mining activities for example, demand a lot of input on the part of potential miners. The energy invested are usually rendered useless as lack of proper prospecting, exploration and mining tools coupled with the little or non-existent technical knowledge become a trial and error exercise which in most instances does not amount to any significant gains

Artisanal mining in the case of TTC is mostly carried out in group ranches which operate on communal basis and therefore no specific individual can lay claim to a piece of land endowed with minerals. Other ASMs are lease holders to sections of land that are either communal (e.g. Tsavolite Mine in Kasigau Ranch), or privately owned by the locals or land owners. In the process of raising funds, ownership status of a given location can be an inhibiting factor as it can discourage investors who tend to look for a stable investment. This means that investors prefer to buy land or if in a partnership co-own the land or simply partner with the owner of the land with minerals.

Literacy levels in most of the ASMs in Taita County is still low as majority of the miners lack the knowledge required to prepare documents such as a business plan which is a must-have for any investor or a financing institution to even entertain the thought of advancing funds or credit to ASM. Other documents required by banking institutions include; a feasibility study report, mining licence, a document detailing repayment plan for the Credit and a proof of a market for the product to be produced. The business plan for example has to reflect the quantity and quality of mineral reserve in question and involves other technicalities of costing and analysis in order to achieve breakeven point. The afore-mentioned would be a jargon to most of the miners although a few are able to prepare such documents which are needed by financiers. Such demands continue to encourage the informal nature of ASM hence minimizing the opportunities of growth that would have emerged had a formal partnership with investors been established.

Since ASM are informal in nature, informal or not so formal partnerships between miners and ‘supporters or sponsors’ have been adopted in some of the mining sites. This was strongly observed in Mkuki, Kasigau and in Alia gemstone mines. The sponsors or supporters would avail the miners with food, water, mining equipment, contingency money and any other relevant item critical to the process of mineral exploitation. The same can be said of many other gemstone mines found in the other areas of the county. Most of these sponsors are exploitative as they get a large slice of the pie resulting from the sale of the gemstones as they are accorded the rights to sell the gemstone leaving only a small percentage to the actual miner. The benefit-sharing between the miner and the sponsor in most cases is unfair. This will in turn discourage the miner from formalizing the venture.

The migratory nature of ASM does not auger well with the finance institutions as it does not inspire trust and accountability in the sector, not to forget that most are informal. Some of these institutions find it hard to believe that the ASMs are capable of paying back the money if credited.

The local financial institutions lack the appropriate professional capacity to design financial products suited to the mining industry.

Existing commercial banking models are limited in their reach and often charge high interest rates while demanding collateral or evidence of sophisticated business plans. As most artisanal and small-scale miners cannot meet the bank’s requirements, innovative microfinance services tailored to diverse artisanal and small-scale mining situations are needed. Government assistance in strengthening ASM groups’ economic planning and in educating banks about this sector could be a useful step in making credit services more accessible to the poor [37].

## VI. ASM AND POVERTY

ASM and poverty is closely associated and the relationship between the two is quite complex. Majority of the ASMs are driven to mining due to poverty and lack of an alternative source of livelihood. Those who constitute the majority of the ASM community at the level of resource extraction, basic processing and local trading, generally live in poverty, with the gains from these activities representing their main source of income. However, the nature of ASM is such that it is exploitative; it draws people away from other more sustainable activities such as agriculture; it does not produce long-term wealth for these individuals; it creates debt; it uses resources inefficiently; and it is not sustainable [38].

In most cases, the informal nature in which ASM is carried out results in poor return on resources and effort invested. Despite this scenario, most miners carry on with operations even though they may go for months on end without any substantial sales. This may end up trapping most of them in a vicious cycle of poverty from which it is hard to escape.

However this type of mining activity takes place in rural and remote areas of TTC where few opportunities exist for formal employment and as such, provides an alternative to large numbers of people who are generally uneducated and poor.

## *ASM Can Perpetuate Poverty*

As with all forms of mining, ASM is a finite activity exploiting a non-renewable resource. As such, the livelihood potential associated with any ASM site is limited to the life of the resource, which is a function of the accessibility, scale and quality of the ore, efficiency of production techniques, the market, the number of miners and the intensity of their labour (SSM CFC report, 2008). ASM can be inefficient in terms of the contribution it can make to livelihoods if it lacks appropriate and adequate technical, financial and market resources. The technical aspects of the mining, which go together with financing, have to be given close attention if any meaningful benefits are to be realized. Efficient mining can only be achieved once the technical elements are taken care of which eventually leads to better production, higher contribution to the local and national economies, and enhanced development in general.

ASM might compromise the levels of education and skills for employment of young people since most of them are tied down in the mines with virtually no time to attend educational or technical institutions. This in the long run will breed a society with low literacy levels and consequently contribute to poverty.

## VII. ROLE OF WOMEN AND YOUTH IN THE ASM WORKFORCE IN TTC

Women constitute 3 to 5 per cent of the ASM workforce in TaitaTaveta County (TTC), fulfilling roles in all aspects of mining, processing, transporting, trading and service provision to the mines. Women are often subject to gender discrimination in terms of access to the resources; ownership and tenure; types of work undertaken; and pay received. They also face elevated risks in terms of health and security and, if they have to bring children to the mines with them, the children too face physical, moral and psychological risks as well as potentially being excluded from education. Women have aptitudes and potential which make them a good focus for interventions to improve ASM livelihoods, with a related positive impact for their children and households.

Women play a major role in artisanal mining than in the LSM sector, and their engagement typically declines as the degree of organization and mechanization increases (WMMF, 2000). Women’s roles vary between and within countries and frequently depend on the location (proximity to villages or homes) and mineral being mined [9, 10, 11]. In addition to working directly in mining, women often work part time at informal mining operations and occupy ancillary roles (e.g., as cooks and service providers). Because women are more frequently associated with transporting and processing materials, as opposed to digging, they are not always identified as miners [39]. Women’s involvement is often invisible, because it frequently takes place in the domestic sphere. There thus may be significant discrepancies between the estimated and actual numbers of women involved in ASM [40]. Furthermore, women typically have intensive domestic responsibilities—typically working four to eight hours more than men per day—which adds to their workload; this is largely unrecognized and undervalued.

Despite women’s significant involvement in ASM, men hold the control and ownership of most assets. Evidence overwhelmingly indicates that land (inclusive of mining areas), incomes from mining and other activities, mining and farming tools, homes, crops, and sometimes even children are primarily owned and controlled by men. Similarly, the benefits from these resources also predominantly accrue to men.

Even where men and women perform similar work, women often make less money for similar tasks

### VIII. FIELD DATA ANALYSIS AND DISCUSSION OF RESULTS

The data under consideration was collected during fieldwork involving approximately 150 ASMs that were actively involved in mining. The respondents were asked to indicate their knowledge and understanding of the ASM sector and how it relates to their day-to-day livelihoods and socio-economic activities. Some of the areas of interest to this study were: mining experience, marital status, education level, gender, market access, training needs, environment, contribution to household income and equipment requirement. The respondents were asked to rank in order of priority the importance of the foresaid areas. The following analyses are as a result of the data collected from the field based on an open-ended structured questionnaire. Most of the respondents interviewed had worked as miners for a period ranging from 1 year to 46 years. Most respondents were in the 10 years bracket.

#### A. Marital status:

Among the miners interviewed 71.3% reported that they were married, 24% were single, 4.7% reported to be widowed. The table below shows the distribution of the marital status.

Table: Marital status

Table 2 Marital status among mining community

	Marital Status	%
<b>1</b>	Married	71.3
<b>2</b>	Single	24
<b>3</b>	Widowed	4.7

Source: raw field data

#### B. Education level:

From the data collected in the field it is revealed that about 4.0% of the respondents had no formal education, 68% had attained primary school education level, 22% had attended secondary education level and 6.0% had attained post secondary level.

#### C. Training:

The study investigated whether the respondents had received any formal training relating to mining. Of interest to the study was the type of training undertaken by the miners in, geological prospecting, business, mineral identification, or Machine operation. There was also need to identify the institution of training. The respondents who had some basic training indicated they had been trained on basic gemmology and geology at TTUC.

Results revealed that 98.5% reported they had received no training while 1.5% received training on geology and gemology. Apparently no training has been conducted in business, mineral identification and machine operation, among others.

The respondents identified their preferred areas of training as follows:

Table 3 ASM Preferred areas of training

	Recommended training Areas (Module units)	No. of Participants	%
<b>1</b>	Practical Mineral Identification	13	16
<b>2</b>	Appropriate Mining Methods	12	15
<b>3</b>	Marketing Skills	12	15
<b>4</b>	Explosives and Blasting	10	13
<b>5</b>	Gemstone cutting and polishing	9	11
<b>6</b>	Field tours	6	8
<b>7</b>	Safety and Occupational health	4	5
<b>8</b>	Exploration and Prospecting for gemstones	3	4
<b>9</b>	Environment and Mining	2	3
<b>10</b>	Entrepreneurial Skills in Mining	2	3
<b>11</b>	Using gemstone waste-productions	2	3
<b>12</b>	Financial management	2	3
<b>13</b>	New Mining law(Act)	1	1
<b>14</b>	Leadership and Org. Skills	1	1
<b>15</b>	Record Keeping	1	1
	Total	80	100%

Source: raw field data

#### D. Gemstone buyers:

From the table below 92.9% of the respondents reported selling their gemstones to local brokers, 0.5%to international companies, 2.0% to local cooperatives, 4.1% to registered dealers and 0.5%to others

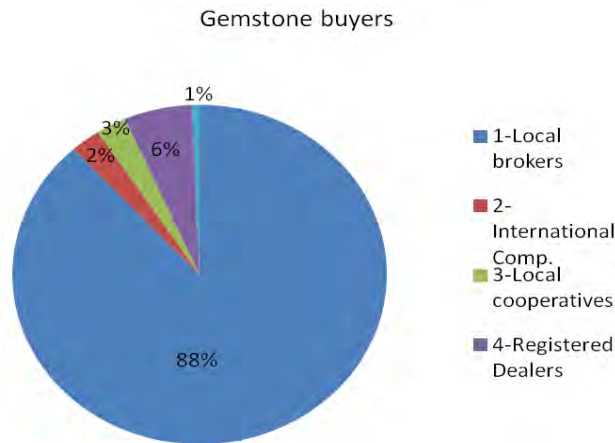

Figure 9 Proportion of gemstone buyers

### E. Gender:

Based on the collected field data, most of the miners were male constituting 96.6% of the total respondents' whereas the remaining 3.4 % were female.

### F. Mining as a source of income:

From the data, 20.9% of the respondents reported that they had other sources of income while 79.1% indicated that mining was their main source of income.

### G. Other source of income:

It was established that there are a number of miners who had other sources of income apart from mining as follows: 83.3% of the respondents cited farming as their main alternative source of income, 13.3% had business to sustain them while 3.3 % indicated other sources apart from the afore-mentioned.

### H. Miners' perception on return on value for their efforts:

The following represents proportion of constituencies that generated this data. Differences were tested statistically with various indicators among constituencies at: ( $p^* < 0.01$   $**p < 0.05$   $***p < 0.001$ )

Proportion of value of effort based on constituency

Table 4 the status of satisfaction among miners with their vocation

Are you satisfied with mining as main source of income?- Value of effort			
Constituency	% Yes (N=15)	% No(N=162)	
Taveta	54.3	80	
Mwatate	35.8	20	
Voi	9.9	0	

\*Difference between the constituencies had no significant difference at p value of 0.13

The table above shows that Taveta constituency had more miners dissatisfied with return on invested effort (80%) while 54.3% reported value for their effort. Most respondents from Voi reported satisfaction with mining as a source of income. Statistically there was no significant difference between the constituencies in terms of return on effort from mining. In

general, a high percentage across the constituencies expressed dissatisfaction with return on effort from mining.

### I. Mining contribution to Household income:

The table below shows that 47.8 % indicated that mining was very significant in Taveta, 34.8% in Mwatate and 17.4% in Voi. Those who reported being very low were as follows 44.4%, 50% and 5.6% for Taveta, Mwatate and Voi per constituency respectively. In general most respondents indicated that mining contributed moderately or very low to house hold income.

Mining contribution to household income based on constituency

Table 5 Perception of contribution of mining to household income

Constituency	%Very significant (N=23)	%Significant (N=10)	%Moderate(N=38)	%Low (N=35)	%Very low (N=36)
Taveta	47.8	40	55.3	42.9	44.4
Mwatate	34.8	40	36.8	45.7	50
Voi	17.4	20	7.9	11.4	5.6
Total	16.2	7.0	26.8	24.6	25.4

\*Difference between the constituencies had no significant difference at p value of 0.756

### J. Equipment support and type based on constituencies

According to field observation very few ASMs groups had received any equipment support except those in Mkuki and Kasigau ranches. Each of the two groups had received a compressor donated by the TaitaTaveta County government. However, these two compressors are inadequate to the needs of the ASMs. One of the compressors at Kasigau is currently not in operation due to lack of accessories and a skilled operator.

### K. Land ownership:

It was observed that land ownership in the TTC mining areas have not been clearly allocated to the ASMs. However in Taveta most ASMs were conducting their mining activities in either privately owned or leased land, whereas in Mwatate majority operated in group ranches. Other ASMs operated in county council land. In general most respondents (53.5%) operated in group ranches while those in privately owned land and leased land constitute 18.3% and 15.5% respectively

Proportion of ownership of land mined based on constituency

Table 6 Proportion of land ownership among ASMs

Ownership of land mined				
Constituency	%Privately owned(N=26)	%Lease(N=22)	%Group ranch(N=76)	%Other(N=18)
Taveta	61.5	59.1	30.3	94.4
Mwatate	15.4	10.2	63.2	5.6
Voi	37.5	31.2	31.2	0
<b>Total</b>	<b>18.3</b>	<b>15.5</b>	<b>53.5</b>	<b>12.6</b>

\*Difference among the constituency has a significant difference at p value 0.000

#### L. HIV/Aids awareness:

The table below reveals that 43% of the respondents were aware of the HIV/AIDS prevalence in the ASM sector while 57% were unaware in the constituencies visited. Mwatate showed the highest awareness level (50%) compared to Voi which had the lowest (4.8%)

Proportion of awareness to HIV/AIDS based on constituency

Table 7 Perception of HIV Aids awareness among ASMs

Awareness to HIV Aids		
Constituency	%No (N=82)	%Yes(N=62)
Taveta	51.2	45.2
Mwatate	32.9	50
Voi	9.9	4.8
<b>Total</b>	<b>57</b>	<b>43</b>

\*Difference among the constituency has a significant difference with a p value 0.035.

#### M. Accessibility to mining site:

The study reveals that overall the ASMs mining sites were very difficult to access due to poor infrastructure. Most ASMs (58.7%) in the constituencies reported great difficulty in accessing their mining sites.

Proportion of difficulty to access mine site based on constituency

Table 8 Perception of the difficulties in accessing mining sites

It is difficult to access mining sites					
Constituency	%strongly agree(n=84)	%Agree(n=31)	%Neutral(n=7)	%Disagree(n=8)	%Strongly disagree(n=13)
Taveta	42.9	51.6	42.9	62.5	61.5
Mwatate	50	32.3	57.1	1.25	15.4
Voi	7.1	16.1	0	25	23.1
<b>Total</b>	<b>58.7</b>	<b>21.7</b>	<b>4.9</b>	<b>5.6</b>	<b>9.1</b>

\*Difference among constituency based on mining access has a significant difference with a p value of 0.098

#### N. Effects of ASM on family stability:

The data shows that 28.4% of the ASMs strongly agree that mining leads to family breakdown. Mwatate reported the highest cases of effects of mining on family stability. However, there was a statistical significant difference among constituencies.

Proportion of family breakdown based on constituency

Table 9 Perception of contribution of ASM to family breakdown

Mining leads to family breakdown					
Constituency	%strongly agree(n=40)	%Agree(n=17)	%Neutral(n=26)	%Disagree(n=31)	%Strongly disagree(n=27)
Taveta	22.5	70.5	42.3	62.5	61.5
Mwatate	49.2	6.8	20.3	1.25	15.4
Voi	12.5	0	18.8	25	23.1
<b>Total</b>	<b>28.4</b>	<b>12.1</b>	<b>18.4</b>	<b>22</b>	<b>19.1</b>

\*Difference among constituency based on family breakdown had a significant difference with a p value of 0.000

#### O. Satisfaction with mining as the main source of income:

The data reveals that 53 respondents were dissatisfied with mining as the main source of income. Among these 68% expressed dissatisfaction due to low income from mining activities, 11.3 due to unpredictable markets and lack of support from the authorities while 7.5% attributed their dissatisfaction to poor working conditions.

Proportion of lack of satisfaction based on constituency

Table 10 Reasons for dissatisfaction among ASMs

Why I'm not satisfied					
Constituency	%Low income	%Unpredictable markets	%Poor working conditions	%Risky	%No support
No.	36	6	4	1	6
Taveta	84.6	3.8	7.7	0	3.8
Mwatate	33.3	27.8	11.1	5.6	22.2
Voi	88.9	0	0	0	11.1
<b>Total</b>	<b>68</b>	<b>11.3</b>	<b>7.5</b>	<b>1.9</b>	<b>11.3</b>

\*Difference among constituency based on satisfaction had a significant difference with a p value of 0.025

#### IX. SUMMARY OF THE FIELD DATA ANALYSIS:

1. From the data it can be inferred that there were benefits derived from mining. However, insignificant amounts of income generated reached the household level. This observation applies to all constituencies.
2. There is need to diversify marketing of gemstones and other minerals to fetch better prices thus increasing their income.
3. There is need for more diversified training to enhance productivity and efficiency.
4. There is need to provide adequate and appropriate equipment support to ASMs to enhance mining technology
5. In terms of land ownership, Taveta was mostly having privately owned and leased land for mining whereas Mwatate had the highest number of land from group ranch for mining. Other land belongs to county government. Therefore, resolving land related issues will create an enabling environment for ASMs
6. The HIV/AIDS level of awareness is significantly high among miners and cuts across all the constituencies where ASMs are conducting their activities. There is however need to educate and sensitize the ASMs through public campaigns.
7. The accessibility to most of the mining sites in the constituencies was reported as significantly poor hence efforts should be put to improve the road infrastructure.
8. A significant number of ASMs agreed that mining affects family stability and there is need to develop family support programs to mitigate the perceived negative attitude society has towards mining in the area.

There is a significant level of dissatisfaction with the return on efforts invested in mining among ASMs, thus relevant interventions to improve their income need to be effected by the appropriate authorities. Contrary to dissatisfaction, the determination of miners to continue mining defies logic.

#### X. CONCLUSION AND RECOMMENDATIONS

The TaitaTaveta ASM community presents both complex challenges and opportunities for initiating and driving change in the county. This community united by a common interest can be used as a force to mobilize and focus group dynamics for social development. However there is little available information regarding the demographics, socioeconomic profiles and household incomes from ASMs a situation which presents a major drawback to research and hence the in-depth understanding of this community. This kind of information, if made available, can be used to mitigate against the frequent land and mining conflicts experienced in the area.

It is hoped that with the new constitution and the proposed new mining Bill, pertinent issues affecting ASMs will be addressed more conclusively and within a sustainable framework of policies.

This study makes a contribution towards the development of a pool of information regarding this subject that hopefully, will support future research. From the study findings it could be recommended as follows.

1. Diversification of economic activities: county government with the help of other donors to support ASMs in setting up small enterprises, agribusiness, poultry and livestock farming.
2. The County and National government should give this industry the recognition it deserves and invest in it commensurately
3. Support and strengthen the ASMs cooperative movement. This movement is currently unstable due to poor management and internal wrangles.
4. In depth study to establish how much is made and management of the revenue from sale, distribution and control of resource
5. There is absolutely no data or information at the County or National level regarding ASMs currently. Such issues as to how many artisanal miners are in the county, the actual amount of money generated by ASM, the accurate assessment of the potential of none extracted mineral potential of the area remain unresolved. Even basic information regarding the locations in the county where mining activity is taking place is lacking. So it is recommended here that a thorough and in-depth socio-economic survey as well as a geospatial mapping survey be carried out focusing on ASMs to assist both governments and other stakeholders in planning for this key industry.

#### REFERENCES

- [1]. Bawa Ibrahim – Minerals Commission, Managing Africa's Resources Sustainably: Challenges of Small Scale Mining in Ghana.
- [2]. Bridges, C.R. (1974) Green grossularite garnets (tsavorite) in East TaitaTaveta County (TTC). *Gems & Gemology*, Summer, pp. 290–295. Scale mining and sustainable development within the SADC Region.
- [3]. Butler, J., 1990, *Gender Trouble: Feminism and the Subversion of Identity*, Routledge publ., L.J. Nicholson, ed., 172p.
- [4]. Çagatay, N., 2001, *Trade, Gender and Poverty*, United Nations Development Programme, 45p.
- [5]. Dreschler, B. (2001) Small-scale and sustainable development within the SADC.
- [6]. Dreschler, B. (2001). Small Scale Mining and Sustainable Development within the SADC Region. Mining, Minerals and Sustainable Development. IIED. London. 2002, [http://commdev.org/files/1798\\_file\\_asm\\_southern\\_Taita Taveta County \(TTC\).pdf](http://commdev.org/files/1798_file_asm_southern_Taita_Taveta_County_(TTC).pdf).
- [7]. Gueye, D. (2001) Small Scale Mining in Burkina Faso. Mining, Minerals and Sustainable Development No. 73, <http://pubs.iied.org/pdfs/G00717.pdf>.
- [8]. Hentschel, T., Hruschel, F. and Priester M. (2003) Artisanal and Small Scale Mining: Challenges and Opportunities, International Institute for Environment and Development and WBCD, London,

- <http://afrim.org.ph/IDLS/files/original/94db37ffd394f7786a06f03b5ccf9c69.pdf>.
- [9]. Hinton, J. (2003) *CASM, an integrated Review for Development Planning*.
- [10]. Hinton, J.J. et al. (2002) Clean artisanal gold mining: a utopian approach? *Journal of Cleaner production* (2003) 11:99-115.
- [11]. Hinton, J.J., Veiga, M.M. and Veiga, A.T.C., 2003, Clean Artisanal Gold Mining: A Utopian Approach?, *Journal of Cleaner Production*, Vol.11, Issue: 2, March, 2003, pp. 99-115.
- [12]. IGF, (2010) A MINING POLICY FRAMEWORK; Mining and Sustainable Development.
- [13]. International Labour Organization (ILO), 1999, *Social and Labour Issues in Small-scale Mines*. Report for discussion at the Tripartite Meeting on Social and Labour Issues in Small-scale Mines, ILO, Geneva.
- [14]. Kenya: Vision 2030. Government of the Republic of Kenya. Ministry of Planning and national Development. Office of the President, Nairobi, 2007.
- [15]. Keller, P.C. (1992) *Gemstones in East TaitaTaveta County (TTC)*. Phoenix. Geoscience Press. Nairobi.
- [16]. KARI, H.K. (2007) Availability and accessibility of ICT in rural communities in Nigeria. *The Electronic Library* Vol. 25 No. 3 pp. 363-372, <http://dx.doi.org/10.1108/02640470710754869>.
- [17]. Labonne, B. (1996) *Artisanal Mining: An Economic Stepping Stone for Women*.
- [18]. Mayer Brown, (2013) *Mining in Kenya – The start of a new era?*
- [19]. Taita Taveta Professionals' forum 2010
- [20]. Moyi E.D (2003) Networks, information and small enterprises: New technologies and the ambiguity of empowerment IN *Information Technology for Development* 10 (2003) pp. 221–232 221.
- [21]. Mutemeri N., Lahiri-Dutt K., Hinton J., Strongman J., Heller K., Eftimie A. (2012) *Gender Dimensions of small scale mining - A Rapid Assessment Toolkit*.
- [22]. Mutie, B. (2012) *Policy Gaps in Mining and Mineral Sector in Kenya*
- [23]. Mwaipopo, R. Mutagwaba, W. and Nyange, D. (2004) Increasing the contribution of Artisanal and Small Scale Mining to poverty reduction in Tanzania, <http://r4d.dfid.gov.uk/pdf/outputs/C393.pdf>.
- [24]. Nyaberi, M.D. and Rop, B.K. (2014) Petroleum prospects of Lamu Basin, South-Eastern Kenya. *Journal of the Geological Society of India, Volume 83, Issue 4, pp. 414-422*.
- [25]. Priester M., Hruschka F., Hentschel T. (2003) *Artisanal and Small-scale mining*, London.
- [26]. *Promotion of Extractive and Mineral Processing Industries in the EAC – Kenya Status*
- [27]. Pohl W. and Horkel, A (1980) *Notes on the Geology and Mineral Resources of the MtitoAndei-Taita Area (Southern Kenya)*, Kenya Austria Mineral Exploration Project.
- [28]. *Report on the gemology course for small scale miners in TaitaTaveta County*, Department of Mining and Mineral Process Engineering, TaitaTaveta University College, 2011.
- [29]. Simonet, C., Okundi, S. and Masai, P. (2001) General setting of coloured gemstone deposits in the Mozambique Belt of Kenya— preliminary considerations. *Proc. 9th Conf. Geol. Soc. Kenya, Nairobi, November 2000*, pp. 123–138.
- [30]. The World Bank (2005) *The Millennium Development Goals and Small-Scale Mining*.
- [31]. The World Bank (2008) *Communities, Artisanal and Small-Scale Mining (CASM) – Issue Brief*.
- [32]. UNDESA (2003) *Poverty Eradication and Sustainable Livelihoods: Focus on Artisanal Mining Communities*. Sssp Project RAF/99/023.
- [33]. WWF (2012) *Artisanal and Small-Scale Mining in protected areas and critical ecosystems programme(ASM. A Global Solution Study.)*
- [34]. Mwandawiro Mganga: *Mining in Taita Taveta County: Prospects & Problems* 2009
- [35]. Cohen et al 2007 *Research Methods in Education, Sixth Edition - Teacher ...*
- [36]. Bertini & Santucci, (2006) *Enabling automatic clutter reduction in parallel coordinate plots*
- [37]. UNEP 2012 *A New Angle on Sovereign Credit Risk - Global Footprint*
- [38]. *SSM CFC Gender in small scale mining*
- [39]. Susapu and Crispin, 2001 *Women and Artisanal Mining: Gender Roles and the Road Ahead*
- [40]. Wasserman, 1999 *WOMEN IN MINING - ICM*



# Shale Geochemistry of Source Rocks in Lokichar and Chalbi Basins, Northwestern Kenya Rift System

Bernard K. Rop, Gilbert K. Bett and Seroni Anyona

**Abstract**—The hydrocarbon potential of the subsurface sedimentary rock sequences of Lokichar (Tertiary) and Chalbi (Cretaceous) was interpreted using some selective geochemical analysis of rock samples in Loperot-1 Well (denoted as LT-1 Well). The total organic carbon (TOC) and other sedimentological parameters were used in order to understand the essential structural features of the source-reservoir-seal rocks petroleum targets. This formed the premise of this paper. Understanding the subsurface structures and depositional environments conducive for hydrocarbon generation and trapping is essential as it forms the basis for exploration rationale. The organic matter richness, facies type and degree of thermal alteration and/or maturation are factors useful in evaluating the potential source rocks. Rock-Eval pyrolysis has been employed on selected rock samples with high TOC for quantification of data, and this would help in precise identification of phases of hydrocarbon generation. Some lithologies from C1, C2 and C3 wells in the Chalbi basin were also examined using the seismic and gamma ray characteristics in order to characterise the shale-rich strata in which there was oil/gas shows.

**Keywords:** Lokichar, Chalbi, sedimentary rock, hydrocarbons, exploration, source rocks

## I. INTRODUCTION

Bounded between longitudes 35°30'E and 36°20'E and latitudes 2°00'N and 3°30'N, the Lokichar basin is segmented as part of the N-S-trending Tertiary Kenya Rift belonging to the Great East African Rift Systems caused by the E-W extensional rift tectonics [3, 8, 9, 10, 15]. This basin system is located in the northwest Kenya; to the southwest of Lake Turkana and southeast of Lotikipi basin (Figure 1). The basin and its geology has lately drawn great attention to geologists due the recent discoveries of oil, despite the paucity of surface exposures due thick cover of Tertiary volcanic lavas and alluvial sediments deposited by the fluvial system constituted by the two major perennial river systems namely, Turkwell and Kerio Rivers [22, 28,29, 36]. These rivers, flowing from

south to north, drain the western high-relief Precambrian basement ranges and volcanic plateaus.

The Chalbi basin and its sub-basins continued as sites of deposition and extension also during the Late Tertiary [12, 13, 14]. It lies between longitudes 37°05'E and 37°47'E and latitudes 2°22'N and 3°20'N. The Mount Kulal and Huri-Marsabit volcanoes which erupted during the Quaternary form the eastern and western shoulders of the basin respectively (Figure 1). The drill core lithologies were available pertaining to wells: C1, C2 and C3 in the Chalbi basin (Cretaceous). Comparing the lithologies from these wells the seismic and gamma ray characteristics have been discussed in order to characterise the strata in which there was oil/gas shows. These characteristics were further seen in the light of the porosities, organic matter and other sedimentological and structural parameters in order to understand the essential features of source rocks, reservoir rocks and the cap rocks [33]. An attempt has been made to extrapolate the knowledge gained for recommending the probable prognostic sites for future drilling in the Chalbi Basin and other sedimentary rift basins (Turkana-Kerio and Lotikipi) in the northwest Kenya (Figures 1 and 2).

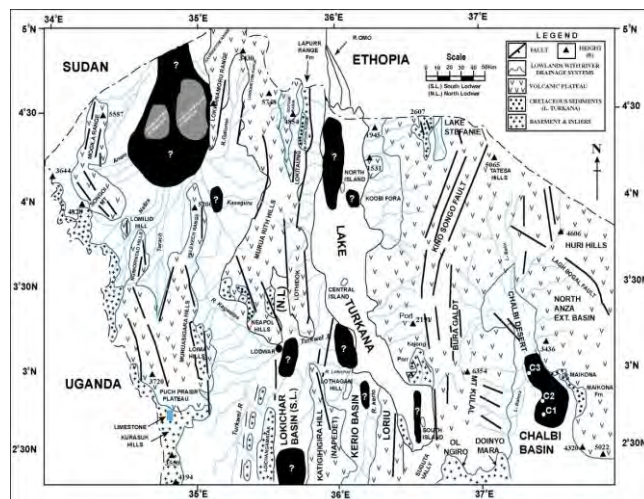

Figure 1 Map showing probable prospective areas for hydrocarbons (shaded black/grey) in the Northwestern Kenya Rift Basins (Lotikipi, Lake Turkana, Chalbi, Lokichar-Kerio)

Bernard K. Rop, Jomo Kenyatta University of Agriculture and Technology, Department of Mining, Materials and Petroleum Engineering, P. O. Box 62000 – CSQ 00200, Nairobi, Kenya.

Gilbert K. Bett, Kenyatta University of Agriculture and Technology, Department of Mining, Materials and Petroleum Engineering, P. O. Box 62000 – CSQ 00200, Nairobi, Kenya

Seroni Anyona Southern Eastern Kenya University, School of Earth Sciences, Institute of Mining and Mineral Processing Department of Geological Science, P.O. Box 33542 – 00600, Nairobi, Kenya.(E-mail: seroni20@yahoo.com)

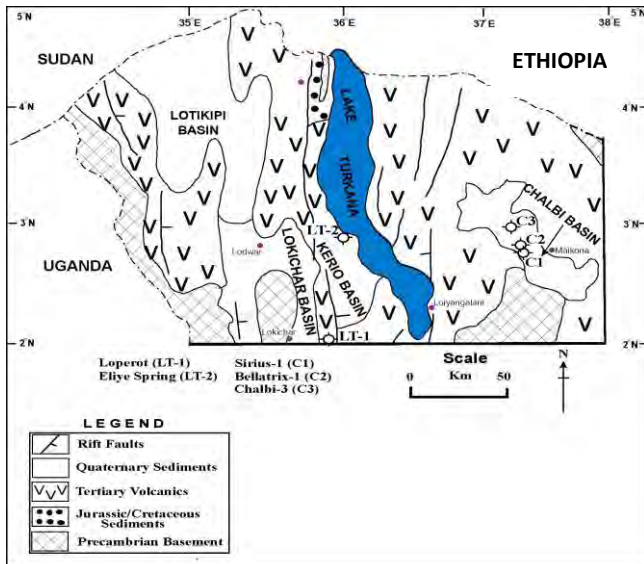

Figure 2 Map Showing Drilled Wells in Northwest Kenya Rifts Basins (Adopted from Rop, 2003, 2012)

The hydrocarbon potential of the subsurface Tertiary sedimentary rock sequences of the Lokichar basin has been interpreted using some selective geochemical analysis of rock samples in the Loperot-1 Well (denoted as LT-1 Well). The distinctive geological setting and physiographical features caused by tectonic rifting and block faulting, which affect sediment deposition and river drainage systems, match the surface and subsurface distribution of rock formations [22]. The characteristics of identified subsurface strata showing oil and gas indications augmented by geochemical analysis of the potential source rocks in terms of total amount of organic carbon (TOC) and temperature maximum (Tmax) present conducive environments and implications for the generation of hydrocarbons (Figures 3, 4 and 5).

Usually, sedimentary rocks do not initially contain petroleum [19], which is generated during burial and diagenesis of the organic matter (OM) they contain [4, 34, 35]. In such intracontinental basins, the temperature gradient is often higher than the normal because of the process of formation of these basins [22, 26, 32] which sometimes reach a gradient of 30°C to 33°C/km. Higher temperatures are also reached by the co-precipitations of radioactive elements along the organic matter [7, 17]. It is observed that the field of crude oil generation expands and reaches a maximum between 2 and 3km depth. However, where there is less generation of crude oil, there is still a possibility of finding gas. The most promising depths for gas, however, are beyond 2.8 km depth [22, 23].

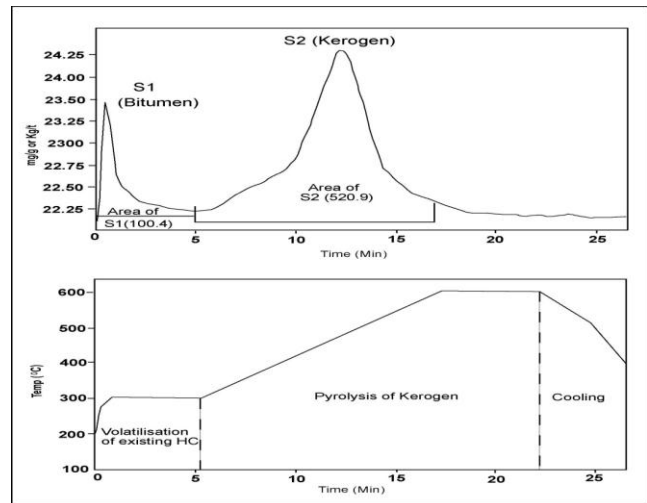

Figure 3 Laboratory rock pyrolysis showing effect of heating an organic-rich sample at 1098 m depth of the LT-1 Well (Tmax 435.3°C)

The LT-1 Well was drilled to a total depth of 2960m. This was not, however, the depth at which the basement was struck. Seismological data shows that the sedimentary section continues up to a depth of about 3500m. Of the four known types of kerogens, the present basin is expected to have either Type 1 or Type III, as the source of organic matter is lacustrine and fluvial [19]. Total organic carbon (TOC) is a measure of carbon present in a rock in the form of kerogen and bitumen. The organic matter is usually converted into kerogen and the type of kerogen depends upon the kind of organic matter that gets buried.

The section below examines some variations of some of the parameters like Total Organic Carbon (TOC) and Tmax (°C) in respect with depth in order to identify the possible presence of source rocks for hydrocarbons generation in the LT-1 Well (Lokichar Basin). For example, intracratonic basin like the one under study does not attract marine OM. The basin has had fluvial and lacustrine environments of deposition [22, 26]. Therefore, the organic matter brought from the vegetation on the higher lands of the time (Cretaceous and Early Tertiary) was buried along with the sediments in the mostly lacustrine and fluvial environments.

The characteristics of identified subsurface strata showing oil and gas indications augmented by geochemical analysis of the potential source rocks in terms of total amount of organic carbon (TOC), maturity indices and temperature maximum (Tmax) present conducive environments and implications for the generation of hydrocarbons.

Thus, the field of crude oil generation expands and reaches a maximum between 2 and 3 km depth.

## II. MATERIALS AND METHODOLOGY

### A. Source rocks characteristics of Lt-1 well, Lokichar basin

As mentioned in sections above, the LT-1 well, drilled in Lokichar basin, penetrated a depth of 2960m. The lithology established through drill core samples showed no substantial presence of carbonaceous strata beyond 2000m depths. Rock samples selected from 800 to 1800m depths, showing some indications of the presence of organic matter, were analysed using Rock-Eval technique.

The section between 800m and 1800m depths was selected because of the reported oil shows and abundance of rocks with high gamma ray values. The aim was to measure the total amount of organic carbon (TOC) and identify the possible source rocks.

### B. Methodology of TOC Analysis

The rock samples (about 1 gram) were first treated with hydrochloric acid - HCL (20% v/v) - to remove inorganic carbonates. The remaining acid was drained using a vacuum pump. The sample was then washed with distilled water and dried in the oven at a constant temperature of about 40°C. The difference in weight before and after HCl treatment/reaction was recorded. Once the system was started, it was left to run for one hour and calibrated for TOC/CO<sub>2</sub>. The dried sample was then analysed in a carbon determinator (IR-212) with an induction furnace and a control computer. Oxygen gas (for burning the sample) and nitrogen gas (for pneumatic lifting of pedestal) were pressure-controlled at 35 pounds per square inch (psi). The combustion chamber pressure was also set between 11 and 12 psi [22, 28].

The CO<sub>2</sub> produced was passed through a carbon IR cell and its volume recorded. The machine automatically recorded the corresponding TOC weight percent.

### C. Rock-Eval Pyrolysis of LT-1 Samples

The selected samples were first treated with organic solvents (Chloroform, Dichloromethane, Menthol Acetone, etc) to remove bitumen. Bitumen content (TOC) also represents the oil content that can be dissolved from a rock. Subsequently, they were subjected to pyrolysis (Rock-Eval) after drying. The dried sample (~100 mg) was put inside a flame ionisation detector (FID) and is heated in a stream of helium at relatively low temperature (up to 300°C) for the first five minutes, in order to remove free or absorbed hydrocarbons (bitumen) that were present in the rock sample before pyrolysis (Figure 3).

## III. SOURCE ROCKS POTENTIAL

### A. Recognition of Potential Source Rocks

On further heating the sample at the rate of 25°C per minute up to 600°C, the main pyrolytic thermal breakdown of kerogen occurs, and is represented by peak S2 (Figure 3). The measure of the S2 area, produced at higher temperatures (550–600°C), decides the actual potential for generation of

hydrocarbons by the sample. The area S2 is a measure of the remaining hydrocarbon generating ability of the organic matter. Oxygen-bearing volatile compounds (CO<sub>2</sub> and H<sub>2</sub>O) are usually passed to a separate (thermal conductivity) detector, which produces S3 response [20, 22, 27, 29]. However, this procedure was not done in the case of LT-1 Well sample. The two areas of S1 and S2 are used to determine the maturation level of kerogen in the source rock. They are expressed in milligrams per gram of original rock (mg/g), or kilograms per ton (kg/ton).

Rocks with S1 + S2 values < 2 kg/ton are not considered potential source rocks for hydrocarbon generation. Between 2 and 5 kg/ton a significant amount of petroleum may be generated but it would be too small to result in expulsion. Source rocks with S1 + S2 values between 5 and 10 kg/ton have the potential to expel some portion of the generated oil [22, 23, 27, 28, 29]. Only source rocks with values >10 kg/ton are considered rich for sufficient oil expulsion [1]. Thus, these rocks have the potential of oil generation as well as expulsion. The actual oil and gas generation can take place only when the threshold temperature (60°C) is reached. It also depends on the maturity level of kerogen, given by the temperature maximum - T<sub>max</sub> (°C).

The T<sub>max</sub> at which the S2 generation peak occurs is also recorded in degree Celsius and is an indicator of source maturity (a function of the degree of maturation). Perhaps the temperature did not reach the threshold of 60°C considering the depth range of these samples or the hydrocarbon that was generated has been expelled and/or migrated. For expulsion to occur the source rocks must get saturated first, a condition which is reached only on maturity of kerogen and temperature.

### B. Temperature Maximum - T<sub>max</sub> (°C)

The temperature maximum (T<sub>max</sub>) mainly depends on maturation level of the organic matter (OM). As a general rule, T<sub>max</sub> (°C) increases with maturity of OM. Figure 4 gives the variation of T<sub>max</sub> with depth. It is seen that there are three peaks or regions (high) at 834m (437°C) and 888m (429°C); 1308m (518°C) and 1650m (537°C); 1749m (535°C) and 1770m (536°C). The highest values of T<sub>max</sub> are obtained only from samples at deeper levels but the variation is not uniform. Achieving a level of maturity of kerogen (within the organic matter in the source rocks) is vital for petroleum exploration [20, 22, 27, 29]. With immature kerogen no petroleum is generated but with increasing maturity, first oil and then gas is expected to be generated. T<sub>max</sub> being an indicator of the maturity, the higher the T<sub>max</sub> the higher would be the degree of maturity. It is also to be considered that more complex kerogen require higher temperatures for breaking.

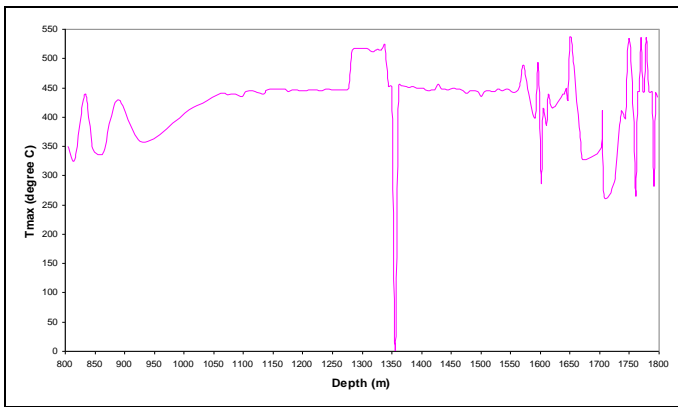

Figure 4 Variations of  $T_{max}$  with Depth

Figure 4 shows that maximum number of samples between 1250m and 1800 fall within the range of  $T_{max}$  445°C and 537°C. From 1062m to 1578m depths the  $T_{max}$  shows a characteristics stable range of 445°C–450°C with a slight variation towards higher side between 1278 – 1350m and a sudden very low value at 1356m depth, but from 1590-1800m the  $T_{max}$  shows very frequent variations as high as 537°C at 1650m depth and as low as 263°C at 1707m depth.

These two levels are also characterised by the gamma rays values. The upper one has higher gamma ray range (>75 API units) while the deeper one has lower gamma ray range (60-75 API units). The similarity between the production index (PI) and  $T_{max}$  curves in this depth range is indicative of a kind of difference between the hydrocarbon type (bitumen or kerogen) on one side, and a difference in the temperature that can be attained [20, 21, 22, 29].

The kind of kerogen that shows lower  $T_{max}$  range is simpler type (maybe Type I) while those samples in the 1600m to 1800m depths range had more complex type of kerogen (maybe Type III). The kerogen breakdown depends not only on the temperatures attained but also on the time which it gets for the breakdown, given sufficient time and temperatures in the range of 100-150°C kerogen breakdown is facilitated. The more complex kerogen, however, takes higher temperature and greater time for the cracking process. The time perception, of course, is in the range of thousands of years or even millions of years.

In the LT-1 Well, oil and gas shows were encountered at depths between 800-1000m and 1400-1600m. The first level is above the sequence showing moderate TOC values (Figure 5). The TOC value of 0.5% is frequently taken as the maximum organic content for a source rock. Below this is not enough hydrocarbons can possibly be generated to saturate the source rock.

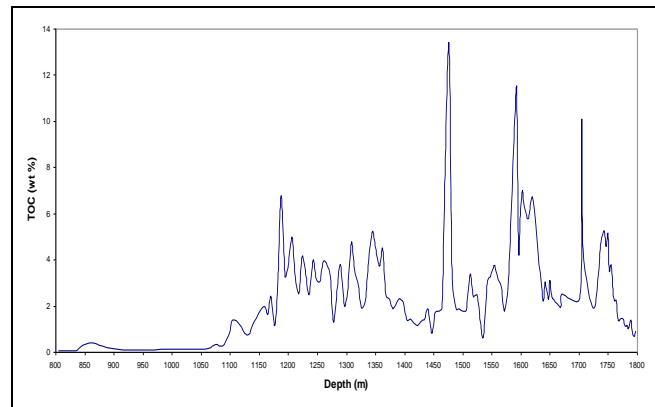

Figure 5 Variations between TOC and Depth

The second level of oil shows is within depth range of samples showing uniform  $T_{max}$  and higher TOC. A normal geothermal gradient will lead to the threshold temperatures of 60–65°C at depth of about 1800m. Therefore it is expected that the kerogen type at the deeper depths in the present case, which represents the frequently maximum ranges of  $T_{max}$  was the principal level for oil formation. Most of the oil and gas shows in the LT-1 Well are above this level and are within rocks with suitable porosity [20, 22, 27].

#### C. Paleogeographic Position

The paleogeographic position of this region (what is presently northern Kenya) was much to the south of the Equator during the Triassic-Jurassic/Cretaceous time [6, 20, 27, 28]. Luxuriant vegetation on land, swampy grounds, humid climate and good rainfall were some of the then prevailing environmental conditions. With such a source, the organic matter (OM) that got buried could only generate the Type I or Type III kerogen whose initial product could be waxy crude or gas.

The analysis helped in determining the proportion and frequency of shale horizons within the otherwise sandy sections, as well as the variations in grain size within the sandstone beds. The radiogenic heat from OM-rich sediments adds further to the temperature gradient, which is otherwise also higher than the normal geothermal gradient in the intracratonic rift basins. Black shales rich in carbon (2 percent weight TOC) as well as syngenetic uranium (up to 400 ppm) though more common to marine sediments, can also be deposited in other (lacustrine) environments which are biologically productive and anoxic. Speedy sedimentation along with basin subsidence prevents the oxidation of organic matter and preserves it for possible hydrocarbon generation.

#### IV. PROGNOSTIC EVALUATION, RESULTS AND DISCUSSIONS

The geophysical methods, used commonly in exploration of oil and gas, the gravity and seismic methods, are more common and effective. Seismic survey is a useful tool for exploration as it helps in covering large areas and in mapping the subsurface rock stratigraphic units bringing out also the

physical characteristics like the degree of compactness, rigidity, porosity and permeability. From the seismic profiles, it was revealed that the frequency of the shaley rocks and compact sandstones increased with depths. These rocks were further distinguished by the gamma-ray logs to demarcate black shales with organic matter, coaly beds and sediments with radioactive elements [20, 23, 29]). The analysis helped in determining the proportion and frequency of the shale horizons within the otherwise sandy sections, as well as the variations in grain size within the sandstone beds. Marine sediments with higher gamma ray (uranium content) values are considered to be better source rocks than those deposited in lacustrine and freshwater conditions [7, 20, 22]. Lacustrine sediments like the present ones have typically low gamma ray radioactivity.

supposed to be more potential for hydrocarbons (kerogen) generation [22, 23 26].

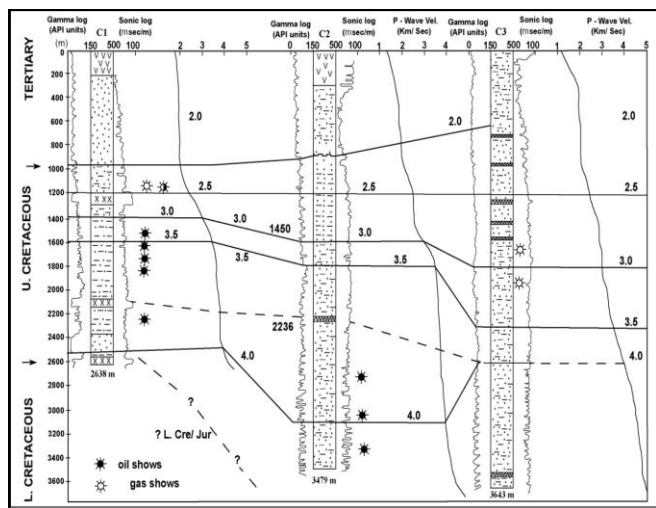

Figure 6 Comparative Lithologies of the Chalbi Basin C1, C2 and C3 Wells Based on Gamma ray and Sonic logs, p-wave velocities and Geological Time

Generally, TOC in shales, especially black shales, always exceed five times that from carbonates or other beds of sediments. The organic matter in carbonates has more potential to generate hydrocarbons than those in shales. In the present case the LT-1 Well does not show presence of carbonates. The lithology is mostly clastics dominated by sandstones with shaley horizons [22, 23].

The recorded two peaks (S1 and S2) represent the volumes of two components of the organic matter (the volumes being proportional to the areas below the peaks). The expelled hydrocarbons, which usually volatilize below 300°C are represented by S1, which provides a measure of already generated hydrocarbons – bitumen [4]. There are not many samples that gave higher S1 values. Most of the samples showed S2 values only up to 20 kg/g and low S1 values (<0.3). The low S1 values show the paucity of hydrocarbons (bitumen) generated below 300°C. S2 values >10 kg/g are

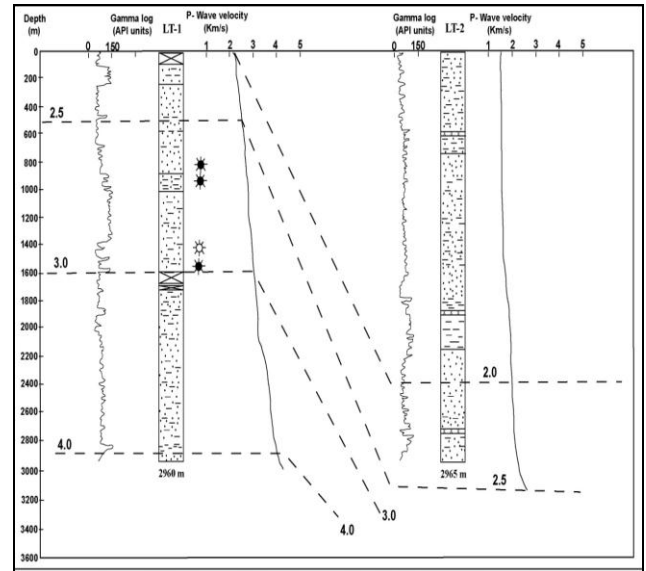

Figure 7 Comparative Lithologies of LT-1 and LT-2 Wells Based on Gamma ray and p-wave velocities.

The radioactive heat from OM-rich sediments adds further to the temperature gradient which is, otherwise, higher than the normal geothermal gradient in the intracratonic rift basins [7]. Black shales rich in carbon (2 percent weight TOC) as well as syngenetic uranium (up to 400 ppm) though more common to marine sediments, can also be deposited in other (lacustrine) environments which are biologically productive and anoxic. Speedy sedimentation along with basin subsidence prevents the oxidation of organic matter and preserves it for possible hydrocarbon generation. In India, there has been a recent discovery of a huge gas field in the near shore regions of the Godavari Basin which contain sufficient humic organic matter (shales and associated coals), deposited in intermediate environment [17].

The present intracratonic rift basins are separated from one another by ridges and horsts of igneous and metamorphic basement and tend to plunge northwestwards to Sudan. Towards the northwestern (Lotikipi basin) and southeastern (Chalbi basin) parts, they are expected to present a correlatable Cretaceous stratigraphy; the stratigraphic facies boundaries may be diachronic. In the central part (Lokichar-Kerio-Turkana basins), the Cretaceous stratigraphy is overlain by Tertiary and Quaternary sediments, many of these sequences being sandwiched between intermittent lava flows [37]. These younger rift basins are a part of the N-S main East African Rift System.

Examples of intracratonic basins are present throughout the northern Africa continent, including areas in Sudan and Libya, as well as Egypt. Their infilled sediments are predominantly

non-marine but it is possible that there is some marine influence during the initial sediments filling of the Chalbi Basin. The geothermal gradients of the Cretaceous and those of the Tertiary should have been different, consequent to the non-uniform mantle upwarping as revealed by the gravity anomaly profiles [20, 22, 28, 29]. Intracratonic basins of these types are poor prospects for the hydrocarbon exploration, but they contain adequate potential reservoir rocks, which can trap whatever hydrocarbons that were generated by the chiefly continental organic matter buried with the sediments (Harding, 1984). There are a few examples (1.5 percent of world's proven reserves) of hydrocarbon generating intracratonic basins of this type (Type I - [32]).

As earlier discussed, the paleogeographic position of this region of what is presently northern Kenya was much to the south of the Equator during that time. Luxuriant vegetation on land, swampy grounds, humid climate and good rainfall were some of the then prevailing environmental conditions. With such a source, the organic matter that got buried could only generate the Type I or Type III kerogen whose initial product could be waxy crude or gas ([3, 4, 19]).

The section below includes discussions, conclusion, prognostic evaluation and recommendations of probable sites for future drilling taking into consideration the subsurface structure and sedimentary stratigraphic sections which could be regarded as source rocks, reservoir rocks and cap rocks [38]. The correlation of all the data, structural, geomorphologic, seismic and gravity as well as gamma ray data, pertaining to drill core well profiles obtained from the three wells (C1, C2 and C3) in the Chalbi basin Cretaceous sequence (Figure 6) have been useful. From the palynological presence of flora and faunal assemblages [16] found in these sedimentary sections the drilling company (AMOCO) concluded that these sediments were deposited in a deltaic and marine-lacustrine environments. The sedimentation in these intracratonic rift basins were also controlled by intrabasinal and marginal faults, some of them reaching also the basement. While examining the subsurface stratigraphy, it is intended also to assess the prognostic oil and gas potential of these basins and extrapolate the information to other parts of these basins, as well as to the northwestern unexplored areas of the Lotikipi basin.

The studies by AMOCO did reveal the presence of good reservoirs and source rocks mainly in the Upper Cretaceous. Based on Bouguer gravity anomalies it was possible to visualise the structural configuration of the part of Chalbi basin in which the three wells were drilled ([20, 22, 27, 29]). The location of C1 well was sited in such that it reached the deepest part of the sedimentary section, immediately to the west of the Kargi fault. The figure also shows that the basin shallows towards the western margin of the Chalbi fault. The sections with source rocks identified in C1 are represented by 1500 – 1800 m and 2300 – 2390 m depths. These rocks have a

high gamma ray values (up to 75 API units) and p-wave velocity values of 3.3 to 3.9 km/s (Fig. 10). The porosity of the upper source rock interval (Rop, 2003, 2012) is good (27%) while the lower one is relatively low (10 – 15%). The depth at which they occur would make the organic matter in these sediments (with TOC >5%) undergo changes to produce hydrocarbons since the temperature gradient would be a contribution by the igneous intrusive activity of a later date.

The section with reported oil and gas shows in well C1 would similarly constituted good reservoir rocks with good to fair porosity (30%). Since the source and reservoir rocks are not much separated vertically, there is a possibility that the oil and gas have not migrated much in this well section. Both the source rocks as well as the reservoir rocks occur only within the Upper Cretaceous stratigraphic section. The Lower Cretaceous sequence, the entire younger section of the Upper Cretaceous as well as the Tertiary sections, have no potential rocks. However, in the areas west and east of this well C1, there could be a migrated oil show, taking into consideration the various intrabasinal faults.

The potential rocks towards the north could be judged by the section of C2 drilled immediately to the north of C1. This well has also revealed depths of the order of 3500 m. The source rocks have been represented in the interval depth 2230 m to 3400 m. They are rich in organic matter with up to 2 percent weight TOC content. This section is characterised by high gamma peaks ranging from 75 to 90 API units and p-wave velocities of 3.8 – 4.1 km/s. Some good to fair porosity reservoir rocks are also present within this source rock section at depths 2730 m to 3370 m. The reservoirs have same gamma ray and p-wave velocity characteristics as source rocks. The source rock section, if extended further into the eastern deeper areas of C2, would probably have better oil and gas potential.

The entire section containing source rocks is mostly confined to the Upper Cretaceous stratigraphic part. The higher gamma ray peaks indicate the presence of radioactive elements with organic matter which enhance the possibility of reaching temperatures conducive for hydrocarbon generation. The areas to the east of C2 could have experienced faster subsidence due to the proximity of the Kargi fault. In the western section there is less possibility of potential source rocks but migration of oil from east to west along tilted faults cannot be ruled out. It will depend upon the channels, on the porosity, and on the intercalations of shales with sandstones.

Unlike the C1 and C2, the well C3 was drilled near the Chalbi fault towards the western part of the basin. It can be seen that it was again drilled in the deeper part of the Chalbi basin but much to the north. Between locations C1, C2 to the south and C3 to the north, a few faults have been interpreted striking WNW – ESE to the north of Mount Kulal. The deepening of the basin towards the west in this section is a departure from what is shown in C1 and C2 wells. Therefore it seems logical

to visualise that this criss-crossing faults should have also contributed to the subsidence of the basin. The figure shows locations of source rocks in the depth range 2300 m to 3100 m, which is comparable with the depths reached in C1 and C2. The source rocks show high gamma ray (60 API units) and p-wave values of 3.6 to 4.5 km/s. The reservoir rocks at C3 well are at shallow depths (1660 – 1700 m and 1860 – 1960 m), and are characterised by low gamma ray (36 – 40 API units) and p-wave values 2.9 to 3.2 km/s.

Gas shows encountered in C3 are within a section which is younger (Upper Cretaceous). However, both the source rocks as well as the reservoir rocks in which gas shows are found are within the Upper and Lower Cretaceous stratigraphic section. This is a departure from the wells C1 and C2 where the source rocks as well as the reservoir rocks are within the Upper Cretaceous section only. Immediately to the east of well C3, there is a possibility that the Lower Cretaceous section containing these potential rocks reaches deeper parts of the basin, which will have higher temperatures and possible radioactive elements.

However, the evidences provided by seismic data for Chalbi subsurface basin have been correlated with the description of the stratigraphic lithologs obtained from the drilled C1, C2 and C3 wells (Figure 7). The lithologs have also been examined in the light of gamma ray data in order to build up a clear understanding of the subsurface stratigraphic formations with respect to seismic profiles. The examined salient structural features containing source rocks, reservoir rocks and cap rocks in the oil/gas-bearing strata based on gravity, seismic and gamma ray profiles, porosities and other sedimentological parameters helped in characterizing possible future prognostic targets (Figure 1) and their implications for hydrocarbons prospecting and exploration in the northwest Kenya basins.

## V. CONCLUSION

While examining the subsurface stratigraphy, it is intended also to assess the prognostic oil and gas potential of these basins and extrapolate the information to other parts of these basins, as well as to the northwestern unexplored areas of the Lotikipi basin. Their infilled sediments are predominantly non-marine but it is possible that there is some marine influence during the initial sediments filling of the Chalbi Basin (Cretaceous), in the north Anza graben [20, 21, 23, 29]. The geothermal gradients of the Cretaceous and those of the Tertiary should have been different, consequent to the non-uniform mantle upwarping as revealed by the gravity anomaly profiles.

Intracratonic basins of these types are poor prospects for the hydrocarbon exploration, but they contain adequate potential reservoir rocks, which can trap whatever hydrocarbons that were generated by the chiefly continental organic matter buried with the sediments. There are a few examples (1.5

percent of world's proven reserves) of hydrocarbon generating intracratonic basins of this type [22].

The examined salient structural features containing source rocks, reservoir rocks and cap rocks in the oil/gas-bearing strata based on gravity, seismic and gamma ray profiles, total organic carbon (TOC), porosities and other sedimentological parameters helped in characterizing possible future prognostic targets and their implications for hydrocarbons prospecting and exploration.

## REFERENCES

- [1] Allen, A.A. and Allen, J.R. (1990): Basin Analysis: Principles and Applications. Blackwell Scientific Publications, Oxford London-Edinburgh, 451p.
- [2] Barker, B.H.(1986): Tectonics and volcanics of southern Kenya Rift Valley and its influence on rift sedimentation. In: Frostick, L.E. et al (Ed), Sedimentation in the African Rifts, Geological Society Special Publication No. 25, pp.45-57.
- [3] Barker, B.H.; Morh, P.A. and Williams, L.A.J. (1972): Geology of the Eastern Rift systems of Africa. Geological Society of American Special Paper 136, 67p.
- [4] Barker, C. (1999): Petroleum Geochemistry in exploration and development: Part 1-Principles and processes. The Leading Edge, Vol. 18, pp. 678-684.
- [5] \_\_\_\_\_ (1999): Petroleum Geochemistry in exploration and development: Part 2-Applications. The Leading Edge, Vol. 18, pp. 782-786.
- [6] Bloom, A.L. (2002): Geomorphology, Third Edition. Prentice-Hall India Pvt. Ltd., New Dheli, 482p.
- [7] Durrance, E.M. (1986): Radioactivity in Geology: Principles and Applications, Ellis Horwood Limited Publishers, Chichester.
- [8] Flores, G. (1974): The S.E. Africa triple junction and drift of Madagascar, Journal of Petroleum Geology, Vol. 7, pp. 403-418.
- [9] Girdler, R.W. (1983): Processing of planetary rifting as seen in the rifting and breaking up of Africa. Tectonophysics, Vol. 94, pp. 241-252.
- [10] Green, L.C.; Richards, D.R. and Johnson, R.A. (1991): Crustal structure and tectonic evolution of the Anza rift, northern Kenya. Tectonophysics, Vol. 197, pp. 203-211.
- [11] Harding, T.P. (1984): Graben hydrocarbon occurrences and structural styles. The AAPG Bulletin, v. 68, pp. 333-362, 1984.
- [12] Key, R.M.; Charsley, T.J.; Hackman, B.D.; Wilkinson, A.F. and Rundell, C.C. (1989): Superimposed Upper Proterozoic collision-controlled orogenesis in the Mozambique orogenic belt of Kenya. Prec. Res., v. 44, pp. 197-225, 1989.
- [13] Key, R.M.; Rop, B.P. and Rundle, C.C. (1987): The development of the Late Cenozoic alkali basaltic Marsabit Shield Volcano, northern Kenya. Journal of African Earth Sciences, Vol. 6, pp. 475-491.
- [14] Key, R.M.; Rop, B.K. and Rundle, C.C. (1987): Geology of Marsabit area. Republic of Kenya, Mines and Geological Department: Report No. 108, 42p.
- [15] Kinyua, M. and Rop, B. K. (2013): Tectonic Evaluation of East African Rift System: Impact on Hydrocarbon Potential: The 1st International Indisciplinary Conference at the University of Eldoret, Eldoret, Kenya: September 3rd – 5th 2013.
- [16] McJuire, M. ; Day, R. and Serra, S. (1985): Dinosaur Fossils of the Lapurr Range, Turkana District, Kenya: Amoco Production Company, Africa and Middle East Region, Report No. 85002.
- [17] Minax Pal, Venkatesh, V., Balyan, A.K. and Sarkar, A., (1992): "Hydrocarbon Prospects of Gondwana Basins in India; Source Rock Studies of Kamthi Sub-Basins of Pranhita-Godavari Graben," Journal of Geological Society of India, Vol. 40, pp. 207-215.
- [18] Morley, C.K.; Wescott, W.A.; Stone, D.M.; Harper, R.M.; Wigger, S.T. and Karanja, F.M. (1992): Tectonic evolution of the northern Kenya Rift. Journal of the Geol. Soc., London, Vol. 149, pp. 333-348.
- [19] North, F.K. (1985): Petroleum Geology. Boston Unwin Hyman Publishers, 631p.

- [20] Rop, B. (2012): Hydrocarbon Potential of Northwest Kenya Rift Basins: A Synopsis of Evidence and Issues. LAMBERT Academic Publishing, 157p.
- [21] Rop, B. K. and Patwardhan A. M. (2013): Hydrocarbon of Source Rocks Evaluation Study of Lokichar Basin, Northwestern Kenya. *Journal of the Geological Society of India*, Volume 81, pp. 575-580.
- [22] Rop, B. K. (2013): Oil and Gas Prospectivity: Northwestern Kenya (Revised Eds.), 152 p. Verlag/Publisher: LAP LAMBERT Academic Publishing, 147p.
- [23] \_\_\_\_\_ (2013): Petroleum Prospects under the Lotikipi Basin, Northwestern Kenya. *African Journal of the Education, Science and Technology*, Nov/Dec 2013, Vol. 1, No. 3, pp. 7-18.
- [24] \_\_\_\_\_ (2013): Petroleum potential of the Chalbi basin, NW Kenya. *Journal of the Geological Society of India*, Volume 81, pp. 405-414.
- [25] \_\_\_\_\_ (1990): Stratigraphic and sedimentological study of Mesozoic-Tertiary strata in Loiyangalani area, Lake Turkana district, NW Kenya. (unpublished M.Sc. thesis, University of Windsor, Canada), 128 p.
- [26] \_\_\_\_\_ (2002): Subsurface geology of Kenyan Rift Basins adjacent to Lake Turkana based on gravity anomalies: In the abstracts of International Seminar on Sedimentation and Tectonics in Space and Time, 16th – 18th April, 2002; Page 83-85. (Dept. of Civil Engineering, S.D.M. College of Eng. & Tech., Dharward – 580 003 India).
- [27] \_\_\_\_\_ (2003): Subsurface stratigraphical studies of Cretaceous-Tertiary basins of northwest Kenya.(unpublished Ph.D. thesis, University of Pune, India), 174p.
- [28] \_\_\_\_\_ (2011): Petroleum Potential of NW-Kenya Rift Basins, A Synopsis of Evidence and Issues, The Exploration & Production Geology website online publication: <http://www.epgeology.com>
- [29] \_\_\_\_\_ (2011): Hydrocarbon Characteristics of Source Rocks in Loperot-1 Well, NW Kenya, The Exploration & Production Geology website online publication: <http://www.epgeology.com>
- [30] Savage, R.J.G. and Williamson, P.G. (1986): Early rift sedimentation in the Turkana basin, northern Kenya. In: Frostick, L.E. (Eds.), *Sedimentation in African Rifts*. Geol. Soc. Special Publication No. 25, pp. 267-283.
- [31] Schull, T.T. (1988): Rift Basins of interior Sudan: Petroleum Exploration and Discovery. *The AAPG Bulletin*, Vol. 72, pp. 1128-1142.
- [32] Selly, C.R., 1985, "Elements of Petroleum Geology," W.H. Freeman and Co. New York.
- [33] Sharma, P.V. (1976): *Geophysical Methods in Geology*. W.H. Freeman and Company, New York, 449 p.
- [34] Tissot, B.P. and Welte, D.H. (1984): *Petroleum formation and occurrence*, 2nd Ed: Springer-Verlag. 538p.
- [35] \_\_\_\_\_ (1984): *Petroleum Formation and Occurrence*, Second Revised and Enlarged Edition: Springer-Verlag Berlin Heidelberg New York Tokyo, 699p.
- [36] Walsh, J. and Dodson, R.G. (1969): *Geology of Northern Turkana*. Geological Survey of Kenya. In: Bishop, W.W. (Eds.), *Scottish Academic Press*, Edinbergh, pp. 395-414.
- [37] Wescott, W.A.; Morley, C.K. and Karanja, F.M. (1993): *Geology of the Turkana Grits in Loriu Range and Mt. Porr areas, southern Lake Turkana, Northwestern Kenya*. *JAE Sci.* v. 16, No. 4, pp. 425-435.
- [38] Winn, R.D.; Steinmetz, J.C. and Kerekgyarto, W.L. (1993): *Stratigraphy and Rift History of Mesozoic-Cenozoic Anza Rift, Kenya*. *The AAPG Bulletin*, Vol. 77, pp. 1989-2005.



# Performance of Aluminium A356 Alloy based Buckets towards Bending Forces on Pelton Turbines.

R.N. Mbiu<sup>1\*</sup>, S. M. Maranga<sup>2</sup> and H. Ndiritu<sup>3</sup>

**Abstract**— Based on affordability, small turbines are forced to operate above optimum conditions in order to produce maximum power making them to fail under excessive water jet loading. Performance of Aluminium A356 alloy based Pelton turbine was evaluated under bending forces condition.

The bucket experiences vibration due to repeated loading since it is mounted as a cantilever onto a disc. If not properly designed or manufactured, a resonance may occur and severely increase the dynamic stress coursing failure. It is important to note that the design of the bucket ensure conversion of jet force into tangential force that eventually causes rotation. However, during this conversion shear and bending forces are induced at the regions where buckets are mounted to the turbine ring.

Bending strength was analyzed with different properties of the buckets. It was observed that bending resistance is an important parameter that controls the turbine failure due to cyclic loading on the buckets.

Content of alumina was found to have significant influence on the bending performance of the buckets. Bending forces were predicted using structural analysis on ANSYS modeling software. The results were observed to lie in close proximity to the experimental results.

**Keywords**— Pelton buckets, Aluminium alloy, Structural analysis.

## NOMENCLATURE

$P_{jet}$	Kinetic power of the water jet	[W]
$m$	Mass flow rate	[kg/s]
$C$	Linear velocity of water jet	[m/s]
$P_H$	Hydraulic power	[W]
$Q_{jet}$	Flow rate	[m <sup>3</sup> /s]
$\rho_\omega$	Density	[kg/m <sup>3</sup> ]
$g$	Gravitational acceleration	[m/s <sup>2</sup> ]
$H_n$	Head	[m]
$F_{jet}$	Jet force	[N]
$x$	Ratio of bucket velocity to jet velocity	
$\zeta$	Efficiency factor for flow in bucket	
$\sigma$	Stress	[N/m <sup>2</sup> ]
$[D]$	Flexibility matrix	
$\epsilon$	Elastic strain	
$E$	Young's modulus	[N/m <sup>2</sup> ]
$\Delta T$	Change in temperature	[ <sup>0</sup> ]
$\nu$	Poisson's ratio	
$u v$	Velocity in x and y direction	
$G$	Shear modulus	[Pa]
$xyz$	Special coordinates	

## I. INTRODUCTION

The socio-economic development and increased living standards with the fast growing industry has led to a major increase in electricity demand and generation. Being the basic input of all kinds of economic activity, electrical energy has become an indispensable component of social life. Less than 20% of the total population and 5% of the rural population in Kenya has access to electricity (World Bank, 2009).

The reduction in use of fossil fuel as energy sources in rural areas which are no connected to power grid is a major concern in order to stop a further decline in the environment [1].

Based on affordability small turbines are forced to operate above optimum conditions in order to maximize power predisposing them to fail [2]. Overworking the turbine subjects the runner buckets to a combination of stresses caused by centrifugal forces and cyclic loads. Centrifugal forces are induced by the mass of fast rotating turbine runner. Cyclic loads are induced as the water jet impinges on the buckets at high speed. Individual buckets undergo high repetitive forces as the turbine operates making the runner vulnerable to excessive loading failure [3]. A study was done on castings of Pelton turbine buckets from recycled aluminium A356 alloy.

In order to increase power output of Pelton turbines different researchers have used different approaches. Previous research consists mainly of numerical, experimental and analytical studies [4]. This ranges from Pelton bucket profile optimization, flow analysis, studies on force redistribution on the bucket, analysis on stress distribution on the bucket, nozzle and casing modification and computer simulations to maximize operation conditions.

Models have been used to predict on power output of hydraulic machines by computational simulation aiming at reducing the time required at the design phase [5]. Various developments on computational simulation for water turbines have already led to substantial improvement in the design and performance of hydro turbines. One of them is Computational Fluid Dynamics (CFD) which is a computer-based tool mainly used for simulating the behavior of systems involving fluid flow and heat transfer processes [6]. The challenge is that the software used is costly.

Maryse Francois et al. [7] developed a design of Pelton wheel called hooped Pelton turbine. It is important to note that the design of the bucket ensure conversion of jet force into tangential force that eventually causes rotation. However, during this conversion shear and bending forces are induced at the regions where buckets are mounted to the turbine ring. These effects were minimized by adding two hoops on either set of buckets. This calls for extra cost on the material used to fabricate the hoops.

R. N. Mbiu, Department of Mechanical Engineering, JKUAT (phone: +254 720 568 273; e-mail: rnjihia2003@gmail.com).

S. M. Maranga, Department of Mechanical Engineering, JKUAT (e-mail: smmaranga@yahoo.com).

Simplified charts have been developed to aid in selection of turbines especially for small scale plants.

George A. et al. [8] presented a technology that accelerated the development of hydro turbines by fully automating the initial testing process of prototype turbine models and automatically converting the acquired data into efficiency hill charts. Unlike reaction turbines like Propeller or Francis, the Pelton runner does not have to be designed for specific working condition. A given turbine can be used for a range of heads and flows; this lives a big gap for experimenting of performance of Pelton turbines based on material from which the runner is fabricated from.

## II. GOVERNING EQUATIONS

In order to increase power output of a Pelton turbine of a given size two parameters were varied. These are:

- i. Head
- ii. Nozzle diameter

### A. Numerical Calculations

Numerical calculations of jet force as a result of head and nozzle diameter variation were done in order to get the equivalent force impacted on the inner surface of the buckets. Calculations based on the empirical formulas of Pelton turbines were done in order to determine the optimum operating conditions for a 0.1524m pitch circle diameter (pcd) turbine. Stresses developed on the buckets were obtained. To validate the results, bending experiments were carried out on bending testing machine. The jet force was calculated from:

$$F_{jet} = \rho_w \cdot Q_{jet} \cdot C_v \cdot \sqrt{2g \cdot H_n} \cdot (1-x)^2 \cdot (1 + \zeta \cdot \cos \gamma) \quad (1)$$

The first consideration is the flow. The speed of the water in the jet is dependent only on the head, and the flow is determined by the speed, the area and the number of jets. Velocity of the jet is given by:

$$V_{jet} = C_v \cdot \sqrt{2g \cdot H_n} \quad (2)$$

$$P_{jet} = \frac{1}{2} \rho \cdot A \cdot V_{jet}^3 \quad (3)$$

Then the parameters were varied in order to increase the turbine power output and the jet loading on the buckets monitored. Investigations were done for power output between 1kW and 10kW.

### B. Modeling

The results of forces from the numerical calculations were used as inputs conditions to do the structural analysis using ANSYS software. Solid modeling was used to develop the models for finite element analysis used in ANSYS structural analysis as shown in Figure 1. This was done using Autodesk Inventor software. The development of parameterized design data in the form of CAD solid models for the bucket was directly imported into the ANSYS software and a block-structured grid analyzed.

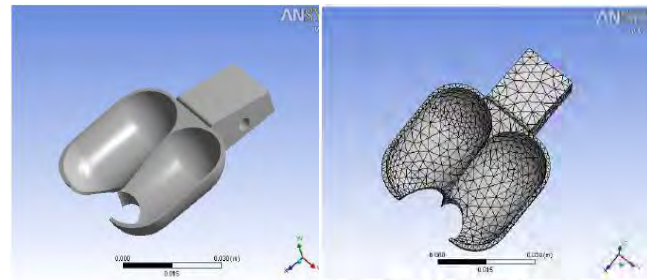

a) Bucket solid model      b) Bucket meshed model  
**Fig. 1.** CAD models

The simulations on stresses were performed on ANSYS software based on the following formulas.

$$\{\sigma\} = [D] \{\epsilon^{el}\} \quad (4)$$

$$\sigma_y = \frac{E_y}{h} \left( v_{xy} + v_{xz} v_{yz} \frac{E_z}{E_y} \right) (\epsilon_x - \alpha_x \Delta T) + \frac{E_y}{h} \left( 1 - (v_{xz})^2 \frac{E_z}{E_x} \right) (\epsilon_y - \alpha_y \Delta T) + \frac{E_z}{h} \left( v_{yz} + v_{xz} v_{xy} \frac{E_y}{E_x} \right) (\epsilon_z - \alpha_z \Delta T) \quad (5)$$

$$\sigma_x = \frac{E_x}{h} \left( 1 - (v_{yz})^2 \frac{E_z}{E_y} \right) (\epsilon_x - \alpha_x \Delta T) + \frac{E_y}{h} \left( v_{xy} + v_{xz} v_{yz} \frac{E_z}{E_y} \right) (\epsilon_y - \alpha_y \Delta T) + \frac{E_z}{h} (v_{xz} + v_{yz} v_{xy}) (\epsilon_z - \alpha_z \Delta T) \quad (6)$$

$$\sigma_z = \frac{E_z}{h} (v_{xz} + v_{yz} v_{xy}) (\epsilon_x - \alpha_x \Delta T) + \frac{E_z}{h} \left( v_{yz} + v_{xz} v_{xy} \frac{E_y}{E_x} \right) (\epsilon_y - \alpha_y \Delta T) + \frac{E_z}{h} \left( 1 - (v_{xy})^2 \frac{E_y}{E_x} \right) (\epsilon_z - \alpha_z \Delta T) \quad (7)$$

$$\sigma_{xy} = G_{xy} \epsilon_{xy}$$

$$\sigma_{yz} = G_{yz} \epsilon_{yz}$$

$$\sigma_{xz} = G_{xz} \epsilon_{xz} \quad (8)$$

The results obtained are compared with the experimental results in terms of:

- i. Deflection and
- ii. Stress on the bucket

## III. METHODOLOGY

CAD drawing of the bucket was made with the dimensions of the bucket based on empirical relations for a 152.4 mm pcd Pelton turbine were; Length = 2.3 times the diameter of the jet, Width = 2.8 times the diameter of the jet, Depth = 0.6 times the diameter of the jet, Angular deflection of the jet = 165° and Bucket angle of setting = 15°.

Computer aided manufacturing (CAM) was then implemented by running the computer software (the G-codes) to control related machinery in the manufacturing of master pattern. Computer Numerical Control (CNC) programming and simulation was developed using OneCNC software. An electronic database in form of G-codes used for machining the master pattern was created. This was then exported to a CNC machine as shown in Figure 2.

Production of the master pattern from a high density plastic as shown in Figure 3 was done and the pattern used to carry out casting.

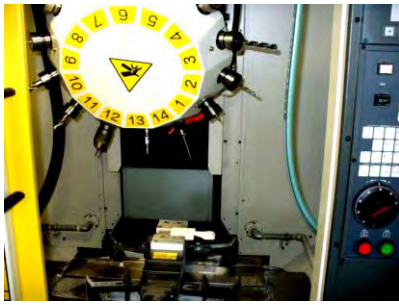

Fig. 2. Machining process of the master pattern



Fig. 3. Master pattern

Casting as one of the viable fabrication techniques due to the complex shape of the bucket and the ease of reproducing the buckets was adapted [9].

Aluminium A356 alloy of mechanical property shown in Table 1. was used to cast the test buckets. Two methods were used to produce the test buckets i.e. investment casting and sand casting.

Table 1. Aluminium A356 alloy composition

Component	Si	Cu	Mg	Ti	Fe	Mn	Zn	Al
Wt %	6.5-7.5	Max. 0.2	0.25-0.45	Max 0.2	Max. 0.2	Max. 0.1	Max. 0.1	93

The traditional method to determine the stress in the Pelton bucket is a stress analysis based on classical beam theory [3]. This is known to deliver conservative results and so leads to very reliable mechanical designs for the normal range of Pelton turbines. The results were then compared with finite element analysis results in order to predict the stresses on the bucket. Two tests were carried out on a bending testing machine as shown in Figure 4. The tests were:

- i. Bucket bending deflection.
- ii. Bucket bending strength.



Fig. 4. Set up of the bending experiment

#### IV. RESULTS AND DISCUSSION

Optimum operating conditions for 152.4mm pitch circle diameter Pelton turbine that would not fail under cyclic loading were obtained. Evaluation of the bucket designs was done by considering this information in conjunction with experimental tests results. Effect of modification on the bucket profile on stress developed was depicted. Jet force for head variations between 15m and 60m was obtained to be between 275.3N and 1105.2N and that of on nozzle diameter variations between 0.028m and 0.048m was obtained to be between 309.2N and 1236.8N using empirical formulas. These were based on power output from 1kW and 10kW.

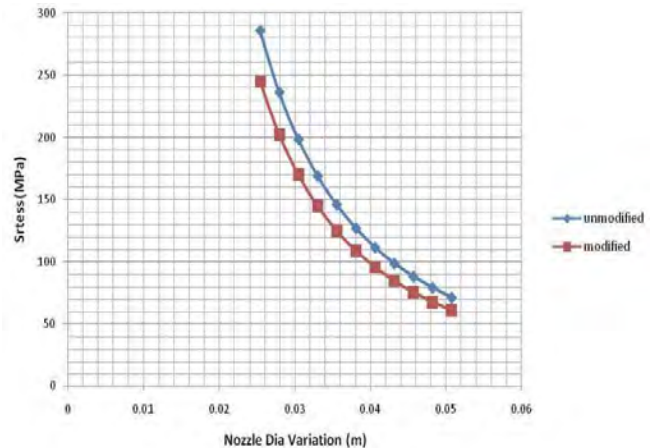

Fig. 5. Variation on nozzle diameter with stress

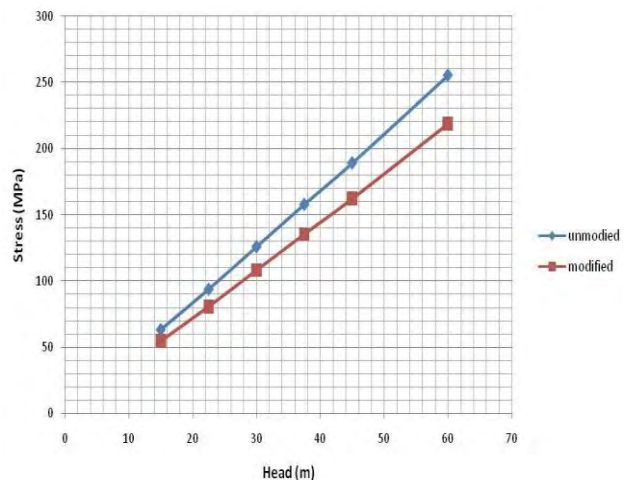

Fig. 6. Variation on head with stress

Figure 5 shows how reduction in nozzle diameter i.e. in order to increase the velocity of the water jet (kinetic power) courses an increase in stresses on the buckets. Increase in the operation head means an increase in potential power and as a result more force will be induced on the buckets and thus there is an increase in stress as head increases as shown in Figure 6. Figure 7 show ANSYS results on stress distribution patterns on the two buckets models.

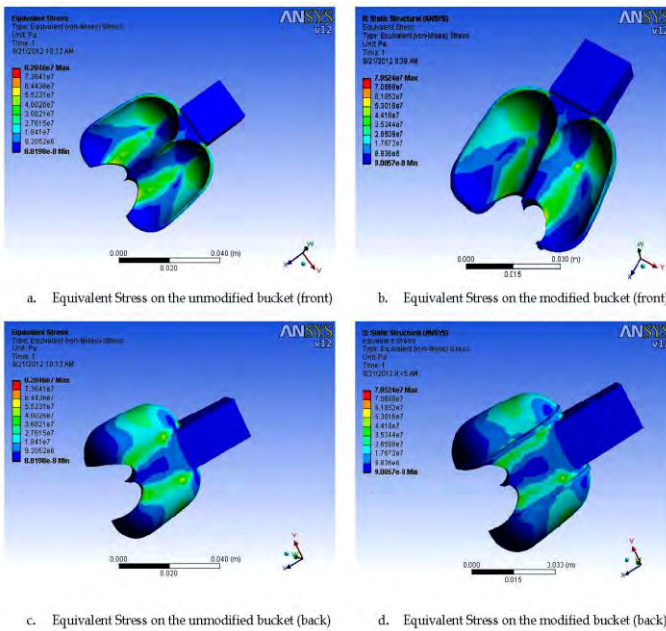

Fig.7. Simulation results on stresses

The main fatigue load on a bucket comes from the jet force. This creates a bending stress in the stem every time a bucket passes a jet. Most turbines will exceed one million bending cycles on the bucket within the first few weeks of operation. The point at which the worst fatigue stress occurs depends on how the buckets are fixed. For a single piece casting the maximum bending moment occurs at the section where each bucket joins the disk, x-x as shown in Figure 8. This gives a maximum tensile bending stress at point. Stresses on the stem of the bucket are caused by two load cases that can cause the bucket to break off.

- i. Runaway- this occurs when the external load is removed from the turbine and the runner accelerates to a high speed. This produces a large centrifugal force in the buckets, which can snap the stem of the bucket.
- ii. Fatigue load- caused by bending stress on the stem due to the water hitting the bucket every time it passes a nozzle.

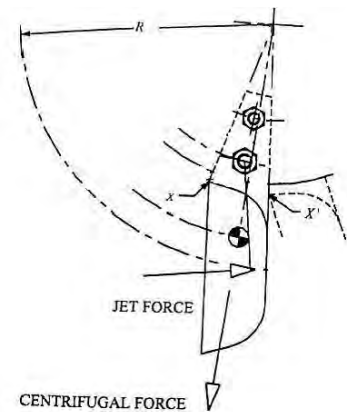

Fig. 8. Main forces on the bucket

The main cause of failure is the fatigue load. The runaway load is easier to address by introducing a clamping mechanism on the stem of the bucket

The jet force was drawn for the maximum bending moment position, and has an effective moment arm of  $0.163 \times D$  about the neutral axis (based on the empirical data). The force required to axially displace the clamp was measured and this indicated the level of security of the buckets upon the hub for vertical shaft arrangement.

## V. CONCLUSION

The research involved modeling and validation of the results experimentally using material that are readily available in Kenyan market. The results showed that by modifying the Pelton bucket profile there was a 14.2% reduction in stress. The modeling results showed that 152mm pitch circle diameter turbine can be operated to produce up to 5kW within a good safety factor without fear of failure in cyclic loading. Experiments conducted verified the modeling results and at equivalent jet loading to produce 5kW power output, the buckets will experience stress of 150MPa which is below the yielding strength of the recycled aluminium A356 alloy. The results will enhance existing knowledge on the performance of recycled aluminium A356 in production of Pelton turbine by castings. This will allow the next generation of Pelton turbines to be designed making use of a combination of empirical know-how from previous experience and an improved physical understanding of the complex Pelton bucket profile.

## ACKNOWLEDGEMENT

The authors thank Prof. Nemoto and Prof. Ando in Ashikaga Institute of Technology, for technical and experimental set support. Mr. Muigai and Mr. Nyanjui for casting technology transfer. This work was also supported by JICA through the Bright Project.

## REFERENCES

- [1] J. L., Hydraulic Machines. Metropolitan Book Co. Privet Ltd, 1975.
- [2] Gilbert Gilkes and Gordon, "Low cost Pelton turbine design and testing," *tech. rep.*, Hydroplan UK Gilbert Gilkes & Gordon Ltd, 2003.
- [3] E. Logan and R. Roy, *Handbook of Turbo Machinery*. Marcel Dekker, Inc., New York, 2003.
- [4] Helmut K. and Sick M., "Thirty years of numerical flow simulation in hydraulic turbomachines," pp. 211–229, 2008.
- [5] Sick M., Keck H., Parkinson E., and Vullioud G, "New Challenges in Pelton Research," in Hydro 2000 Conference, Bern, Switzerland, 2000.
- [6] Kvicinsky S., Kueny J. and Avellan F., "Numerical and Experimental Analysis of Free Surface Flows in a 3D Non-Rotating Pelton Bucket," in The 9th International Symposium on Transport Phenomena and Dynamic Rotating Machinery, Honolulu, Feb. 2002.
- [7] Mayse F., Pierre Y. L. and Gerard V., "Development and Recent Projects for Hooped Pelton Turbine," *tech. rep.*, Alstom Power, 2002.
- [8] George A. Aggidis\*, Audrius\_Zidonis "Hydro turbine prototype testing and generation of performance curves: Fully automated approach" *Renewable Energy* 71 (2014) 433e441.

# Integration of GIS and Multicriteria Evaluation for School Site Selection A Case Study of Belgut Constituency

Philip Kiprono Talam\* and Moses Murimi Ngigi

**Abstract-** Site selection is a complex problem that involve, technical, political social, environmental and economic demands that are difficult to satisfy via one method which may be in conflict with others. Schools need be located on safe places; these safe locations should also be optimal and economical to the public in terms of accountability. Location of these schools has always been done without use of any scientific methods and has led to sprouting of schools located in unsuitable locations. The study area, Belgut Constituency in Kericho County, has schools with less than minimum land size, over enrolment and close to flood prone areas. This was due to lack of regulations on establishment of new emerging schools. Hence there is need to use combination of Geographical Information Systems (GIS) tools and multi criteria evaluation (MCE) methods in locating them in the most suitable location. This way, incidences of congested, dangerous locations, underutilized schools and human bias will be eliminated. The research study objective was to locate the physical site for any school using GIS technology integrated with Analytical Hierarchy Process (AHP), a tool in MCE for finding a suitable location of any new school. Also a weighted overlay method, a tool in ArcGIS, was used to combine all the identified criteria and the results indicated that there are suitable and economically viable areas to add new schools to the eastern part of Belgut which totals to 32 Ha with a small part falling in the central and south western part. From the results it was recommended that in locating new schools the management should embrace use of GIS technology integrated with MCE methods in locating their new schools effectively economically and socially. The authority concerned with school location and safety need to make and published a preferred criteria for use in Kenya.

**Key words**-suitability analysis, MCE, AHP

## I. INTRODUCTION

Prioritization requires general and diverse economic, social, political, environmental, cultural and other criteria that reach beyond the familiar process of deciding on the best alternative in making a single decision. Decisions about decisions are more difficult as the best choice for each particular decision is often unknown requiring a large amount of time and resources to determine. [1]

A school site need to meet some conditions and hence the need to locate them on suitable locations and this research

aims to apply systematic procedures to obtain the most suitable location as is proposed in the District Focus for Rural Development [2] and obviously as a way of scientific justification of a preferred location for a school. This research project will zero in to a case study of siting primary schools in Belgut constituency with the endeavour to find optimum site for schools which are economically viable and safe.

GIS is used to identify candidate sites for new primary schools. The procedure followed under a GIS framework rejects the unacceptable sites considering pre-determined factors exclusively, contained in the form of multiple layers of attribute information to select the candidate sites.

It also requires some framework like minimum and maximum distance between schools, roads, rivers, towns or factories if any and capacity versus land size of existing schools. In this application, GIS is a screening tool in a site selection process to narrow the number of candidate sites, subsequently leading to one or more suitable sites for a school

Development projects are often located by undefined means sometimes just because money or space is available and continuity is not obvious since projects are not mapped on regular interval to easily visualize the spatial distribution and expansion. Using modern ways of site location would also benefit the entire region uniformly not depending on regions where decision maker's supporters come from. Other problems include the lack of adequate awareness by the public, evaluation, political leaders picking the part of management committee yet they are signatories themselves obviously poses conflict of interest. Scientific decision making could be a solution.

In the struggle for equity and poverty reduction universal free primary education was introduced and has increased enrolment by over 1.5 million pupils since 2003, currently there are 4,215 schools to cater for about 3.2 million school-age children. It will, therefore, be necessary to build additional schools and provide support to children from vulnerable households. [3].The potential to start new schools, funded through devolved funds and the community threatens the efficient use of resources in education sector. There has been efforts to improve the quality of school infrastructure and also to start new schools, mainly through Constituency Development Funds, and community support financing but

Phillip Kiprono Talam, Institute of Geomatics, GIS and Remote Sensing (Email address: [Philip.talam@gmail.com](mailto:Philip.talam@gmail.com))  
Moses Murimi Ngigi, Institute of Geomatics, GIS and Remote Sensing

new unplanned school facilities continue to put a strain on available inputs, especially teachers.

There is need therefore, to ensure that devolved funds are not used to start “small schools”, which cause further inefficiencies in the system, but for the most over-crowded schools. Achieving national objectives with decentralized funds remains a challenge. The safety standards manual for schools in Kenya has considered safety inside school compound [5] and hence the need to input automated siting techniques like GIS technology to improve on this. Modern technologies are not embraced like the field of ICT and schools location is not systematic since multi criteria evaluation to determine hierarchy of factors is not a common practice in school site selection which would emphasize on the most suitable sites as per a combination of policies and conditions such as safety, population, poverty levels, accessibility, availability of man power like teachers in this case, terrain and the coverage/hinterland.

The study’s main objective is to demonstrate the ability of GIS in locating schools basing on suitability analysis using multi criteria evaluation (MCE) approach. It involves exploration of the use of GIS technology integrated with MCE method in supporting decision making for suitable school locations. Development of a database of the primary schools and the location model using weighted overlay method are the major tasks in this endeavour.

Spatial scope of the research is the Belgut constituency in Kericho County (Fig.1) which is mainly an agriculturally rich area with Tea and dairy farming as her major income earner.

Automation has been lauded in many sectors like in engineering and production firms. GIS is a most recent and reliable tool and inevitably of great use in this modern world and the fast changing technology and need be embraced. Indeed geospatial mapping of development projects is a way of managing and monitoring fair and safe locations of schools but not much is being done on multi criteria evaluation. GIS technology is cost effective, efficient, and accurate and eliminates human bias in location of new schools. The vision 2030 acknowledges that GIS is a tool of importance in achieving the goals in a wide number of applications like economic, social and political governance. The school safety standard has concentrated on the safety inside the compound hence a look at external factors for school location appears a gap and is part of the basis for this research.

Suitability Analysis is the process and procedures used to establish the suitability of a system, that is, the ability of a system to meet the needs of a stakeholder or other user. Suitability analysis in a GIS context is a geographic, or GIS-based process used to determine the appropriateness of a given area for a particular use. The basic premise of GIS suitability analysis is that each aspect of the landscape has intrinsic characteristics that are to some degree either suitable or unsuitable for the activities being planned. Suitability is

determined through systematic, multi-factor analysis of the different aspect of the terrain. Model inputs include a variety of physical, cultural, and economic factors. The results are often displayed on a map that is used to highlight areas from high to low suitability [7].

A GIS suitability model typically answers the question, "Where is the best location?" Whether it involves finding the best location for a new road or pipeline, a new housing development, or a retail store. For instance, a commercial developer building a new retail store may take into consideration distance to major highways and any competitors' stores, then combine the results with land use, population density, and consumer spending data to decide on the best location for that store.

A number of suitability analysis using the proposed method has been conducted: [8]-[10] and [12]-[13].

The Kenyan government has historically responded to the emerging social and public problems through establishment of various decentralized financing mechanisms to redress the underlying causes of the problems [11]. The struggle to develop the country involve development projects that may be decentralized and need fair distribution and on suitable locations.

In a site selection exercise, the analyst strives to determine the optimum location that would satisfy the proponents' selection criteria. The selection process endeavours to optimize a number of objectives desired for a specific facility which usually involve a number of decision factors that are often contradicting and as a result, the process often involves a number of possible sites of which, each has advantages and limitations.

Suitability analysis is a GIS-based process applied to determine the suitability of a specific area for considered use. It reveals the suitability of an area regarding its intrinsic characteristics (suitable or unsuitable). The combination of spatial Analytical Hierarchy Process method as one of the commonly used methods of spatial multi criteria analysis (SMCA) with GIS is a new trend in land suitability analysis. [8].

There exists a number of approaches applied in suitability analysis such as the Geographically Weighted Regression (GWR), the Spatial Analytical Hierarchy Process (AHP) Method (SAHPM) and MCE. The MCE method used, weighted overlay, requires that all factors be standardized, or transformed into units that can subsequently be compared [14].

Building of new schools entails planning and mapping of old schools to make sure that some areas don't have more schools than they need at the expense of others and GIS can offer the best maps for both the existing and the expected school locations. Mapping of population versus schools or versus literacy level of the Kenyan society would assist the government come up with the best locations of new schools[6]

*A. Analytical Hierarchy Process*

Analytic Hierarchy Process (AHP) is one of the most commonly used MCE tools. AHP is a method that allows the consideration of both objective and subjective factors in ranking alternatives. Since its introduction in the mid-1970s by Thomas Saaty, A paper in the Journal of Mathematical Psychology [15].precisely described the method. AHP is a method for ranking decision alternatives and selecting the best one when the decision maker has multiple criteria [16].

Since its introduction, AHP has been widely used for example in banks, manufacturing systems, operator’s evaluation, site selection, software evaluation, evaluation of website performance, strategy selection, supplier selection, selection of recycling firms competence evaluation , weapon selection , underground mining method selection and its sustainability , software design , organizational performance evaluation , staff recruitment, warehouse selection, technology evaluation, route planning, project selection ,customer requirement rating , energy selection and university evaluation [17] , construction method selection [18] and many others. Several papers have compiled the AHP success stories such as [19]-[26].

In AHP, preferences between alternatives are determined by making pairwise comparisons. In a pairwise comparison, the decision maker examines two alternatives by considering one criterion and indicates a preference. These comparisons are made using a preference scale, which assigns numerical values to different levels of preference [27]. The standard preference scale used for AHP is 1-9 scale which lies between equal importance to extreme importance. Therefore, if the importance of one factor with respect to a second is given, then the importance of the second factor with respect to the first is the reciprocal. Ratio scale and the use of verbal comparisons are used for weighting of quantifiable and non-quantifiable elements [28].

The AHP enables the decision-makers to structure a complex problem in the form of a simple hierarchy and to evaluate a large number of quantitative and qualitative factors in a systematic manner under multiple criteria environment in conflict. The application of the AHP to the complex problem usually involves four major steps [29]:-

1. Break down the complex problem into a number of small constituent elements and then structure the elements in a hierarchical form- problem modelling.
2. Make a series of pair wise comparisons among the elements according to a ratio scale - weights valuation.
3. Use the eigenvalue method to estimate the relative weights of the elements- weights aggregation.
4. Aggregate these relative weights and synthesize them for the final measurement of given decision alternatives-sensitivity analysis

*B. Consistency of judgment*

As priorities make sense only if derived from consistent or near consistent matrices, a consistency check must be applied.

[15] proposed a consistency index (CI), which is related to the eigenvalue method:

$$CI = \frac{\lambda_{Max} - n}{n - 1} \text{ -----1}$$

Where;

n= number of factors

$\lambda_{Max}$  =maximal eigenvalue = the sum of products between each element of the priority vector and column totals

The consistency ratio, the ratio of CI and RI, is given by:

$$CR = \frac{CI}{RI} \text{ -----2}$$

$$S = \sum W_i X_i X \Pi c_j \text{ -----3}$$

S =is the composite suitability score

$X_i$  =Factor scores (cells)

$W_i$  =Weights assigned to each factor

$c_i$  =Constraints (or Boolean factors)

$\Sigma$ =Sum of weighted factors

$\Pi$  -Product of constrains where the digit 1 refer to suitable and 0 refer to unsuitable.

RI stands for random index and represents an average CI for a huge number of randomly generated matrices of the same order. It is an expected RI, so CR is the ratio between the consistency index and the expected one hence the bigger it is, the worse the data, by that measure. Usually, RI is not computed instead tables are used.

The concept of consistency, along with the consistency index, the random index, and the consistency ratio, was proposed by Saaty who calculated the random indices [15], (Table 1)

Table 1 random indices

n	3	4	5	6	7	8	9	10
RI	0.5	0.	1.1	1.2	1.3	1.4	1.4	1.4
	8	9	2	4	2	1	5	9

From Saaty, 1977

*C. Parameters for suitability analysis*

Expert opinion was critical in this phase, Literature review of various references, interviews with experts from National Environmental Management Agency (NEMA), and a look at available data helped in identifying the critical requirements for suitable site for a school as follows.

*1) Proximity to Major Roadways*

The site should not be adjacent to a major road or freeway that any site-related traffic and sound level studies have determined would have safety problems or sound levels which adversely affect the educational program. Trucks on public roads release hazardous smoke and have a greater incidence of accidents, spills, and explosions. When evaluating a site near a major roadway, a schools administration needs to evaluate risks by doing an environmental impact assessment.

Highway setbacks from schools are not established in law. However, experience and practice indicate that distances of at

least 150 m are advisable as per expert interview although this varies so much depending on traffic levels.

*2) Noise*

Noise is unwanted since it is harmful. Too loud noise is distracting or, worse, injurious. The sound measured at 30 decibels is ten times as loud as the 20 decibel whisper. The normal range of conversation is between 34 and 66 decibels. Between 70 and 90 decibels, sound is distracting and presents an obstacle to conversation, thinking, or learning. Above 90 decibels, sound can cause permanent hearing loss. [31]

In determining whether noise is loud, unreasonable, unnecessary or unusual, the following factors may be considered-

- (a) Time of the day
- (b) Proximity to residential area
- (c) Whether the noise is recurrent, intermittent or constant
- (d) The level and intensity of the noise
- (e) Whether the noise has been enhanced in level or range by any type of electronic or mechanical means
- (f) Whether the noise can be controlled without much effort or expense to the person making the noise.

The Kenyan case is manned by NEMA gazette regulations. No person shall use or operate any radio or receiving set, musical instrument, phonograph, television set, any other machine or device for producing or reproducing sound or any other sound-amplifying equipment in a loud, annoying or offensive manner such that the, noise from the device;

- a) Interferes with the comfort, repose, health or safety of members of the public
- b) Creates a risk thereof, within any building or, outside of a building, at a distance of 30 meters or more from the source of such sound, or
- c) Interferes with the conversation of members of the public who are 30 meters or more from the source of such sound. [32]

However noise mapping has concentrated in towns like Nairobi, Mombasa, Kisumu and Eldoret. An interview with a GIS expert in NEMA claims that the area of study is ‘quit quiet’.

Basing on the theoretical understanding and the environmental expert advice dummy data was generated covering the study area. This was generally found to be high along main road, towns and near factories.

*3) Air pollution Index*

Table 2: Air Pollution Index

<b>Air Quality Index (AQI) Values</b>	<b>Levels of Health Concern</b>	<b>Colours</b>
0 to 50	Good	Green
51 to 100	Moderate	Yellow
101 to 150	Unhealthy for Sensitive Groups	Orange

151 to 200	Unhealthy	Red
201 to 300	Very Unhealthy	Purple
301 to 500	Hazardous	Maroon

Source-EPA

The API is based on five pollutants: ground-level ozone, particulate matter, carbon monoxide, sulphur dioxide, and nitrogen dioxide.

This is also controlled by NEMA though the regulations in Kenya have not been gazetted. The study area also has no data and basing on literature available, dummy data was used. The United States Environmental Protection Agency (EPA) has developed an index called the Air Quality Index which they use to report daily air quality (table 2). This AQI is divided into six categories indicating increasing levels of health concern. An AQI value over 300 represents hazardous air quality whereas if it is below 50 the air quality is good. [33]

*4) Proximity to High-Voltage Power Transmission Lines*

Electric power transmission lines maintained by power companies may or may not be hazardous to human health. Research continues on the effects of electromagnetic fields (EMF) on human beings. However, sites should be done with caution about the health and safety aspects relating to overhead transmission lines. Most departments of health recommend a minimum of 107 meters from edge of way leaves [34].The high tension power line is one of 400Kv that requires a way leave of 60 meters.

*5) Proximity to flood areas*

The study area is generally hilly hence not much effect is caused by flood and flood data was unavailable for the study area and information basing on the last floods via interviews showed that the worst was in 1961 of which one river busted its banks and one school was closed since it was submerged.

*6) Proximity to streams*

Water is important resource for school children, however locating schools close to streams may be disastrous since flash floods and water pollution may occur and children will be affected. Experts recommend a minimum of 150 meters away from the shores. Stream data was captured from topographical sheets from survey of Kenya.

*7) Proximity to factories*

Factories emit fumes and are also noisy and surrounding it may be residential area for the workers and unplanned centre is bound to sprout. Expert recommends a minimum distance of 500 meters from the factory as a safe distance for a school location.

*8) Proximity to other schools*

Distance to other school based on how far a pupil should walk to school is a major factor in school location. Ministry of Deduction experts recommended one to two kilometres as a minimum walking distance. Existing schools data was sourced from schools mapping project and Kericho West education office.





For purpose of weighted overlay, spatial and non-spatial data were harmonized to same scale from score one to four where not suitable was assigned 1, less suitable-2, suitable-3, and most suitable-4 and factor layers generated in ArcGIS. SAHP a tool in MCE was then used to rank them and via a model suitable school locations generated (Fig. 3).

### 2 Data collection

The following parameters were identified and used for school location; distance from factories, distance from towns, distance from the main road, air pollution, noise level, gradient of terrain, flood prone areas, distance from stream, distance to schools with/without expansion space, distance from high voltage electrical transmission line, population density and distance to existing schools. Data collection was from various organizations which included NEMA, Ministry of Lands Housing and Urban Development, Ministry of Education, Kenya National Bureau of Statistics, desktop study and the expert interview. Some data were unavailable like the noise maps, air pollution index maps and the flood maps and dummy data were generated basing on expert interviews coupled with information from literature and guidelines that have been done in other countries.

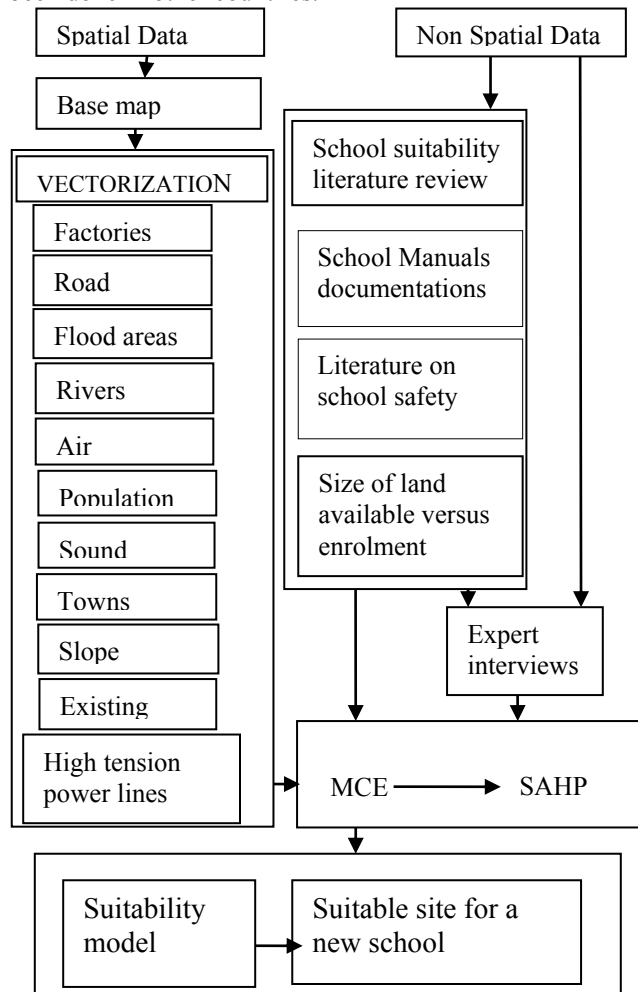

Fig. 2: Flowchart

Table 3: Suitability tolerance

Suitability tolerances	Suitability	class
<b>High tension power</b>		
0-150	1	Not suitable
150-300	2	less suitable
300-450	3	Suitable
>450	4	Most suitable
<b>proximity to flood prone</b>		
0-500	1	Not suitable
500-1000	2	less suitable
1000-1500	3	Suitable
>1500	4	Most suitable
<b>Distance from streams (M)</b>		
0-150	1	Not suitable
150-300	2	less suitable
300-450	3	Suitable
>450	4	Most suitable
<b>Day time sound level</b>		
0-50	4	Most suitable
50-60	3	suitable
60-70	2	Less suitable
>70	1	Not suitable
<b>API readings</b>		
0-50	4	Most suitable
50-100	3	suitable
100-150	2	Less suitable
>150	1	Not suitable
<b>Proximity to factory area</b>		
0-500	1	Not suitable
500-1000	2	less suitable
1000-1500	3	Suitable
>1500	4	Most suitable
<b>Distance from towns (M)</b>		
0-300	1	Not suitable
300-600	2	less suitable
600-900	3	Suitable
>900	4	Most suitable
<b>Proximity other schools</b>		
0-1000	1	Not suitable
1000-1500	2	less suitable
1500-2000	3	suitable
>2000	4	Most suitable
<b>proximity to school with</b>		
0-2000	1	Not suitable
2000-3000	2	Less suitable
3000-4000	3	suitable
>4000	4	Most suitable
<b>Proximity to main roads</b>		
0-150	1	Not suitable
150-300	2	less suitable
300-450	3	Suitable
>450	4	Most suitable
<b>Slope</b>		
>30°	1	Not suitable
25°-30°	2	less suitable
15°-25°	3	Suitable
<15°	4	Most suitable
<b>Population density (per sq.</b>		

<b>Suitability tolerances</b>	<b>Suitability</b>	<b>class</b>
0-200	1	Not suitable
200-300	2	less suitable
300-400	3	suitable
>400	4	Most suitable

restricted value is used for areas to be excluded from the analysis and finally each input raster is weighted according to its importance or its percent influence. The weight is a relative percentage, and the sum of the percentage influence (weights) must equal to hundred percent

### 3 AHP Ranking

Ranking of the criteria was based on expert opinion and available literature where three levels were and 12 sub criteria were identified (Fig.3).

### 4 Computation of weights

Data processing involved Vectorization then systematic formation of the model which included interpolation, generation of euclidean distances, clipping, reclassification and weighting via weighted overlays tool using the composite suitability score.

The layers were each classified into four zones ranging from 1 to 4 where 4 represent cells on most suitable layers and suitability reduces gradually to 1 representing cells of unsuitable regions (Table 3).

From the expert's opinion via interviews, the factor ratings were put to matrix format and using Excel software were normalized by dividing the cell value by its column sum and priority vector (weights) obtained by determining the mean value of each row. Priority matrix are then computed and further used to compute the Eigen vectors and CR (equations 1 to 3)

To normalize the values, the cell value is divided by its column total and to calculate the priority vector or weight, the mean value of the rows is determined. For level two rankings, the procedure is the same as that of level three.

### 5 Procedures in ArcGIS programe

Vector data is processed using ArcGIS software by generation of Euclidean distances then classifying as per factor scores according to the experts' advice (Table 3)

The reclass tools provide a variety of methods that allow reclassification or change input cell values to alternative values.

The most common reasons for reclassifying data are to replace values based on new information, Group certain values together, Reclassify values to a common scale (for example, for use in a suitability analysis or for creating a cost raster for use in the Cost Distance function) or to Set specific values to No Data or set No Data cells to a value.

Finally weighted overlay tool is used to generate suitable sites for schools. Weighted overlay, overlays all the factors using a common measurement scale and weights each according to its importance (in this case common scale was 1 to 4 in each layer)

All input raster are integer since floating-point raster have been converted to an integer raster using the reclassification tools. Each value class in an input raster is assigned a new value based on an evaluation scale. These new values are reclassifications of the original input raster values. A

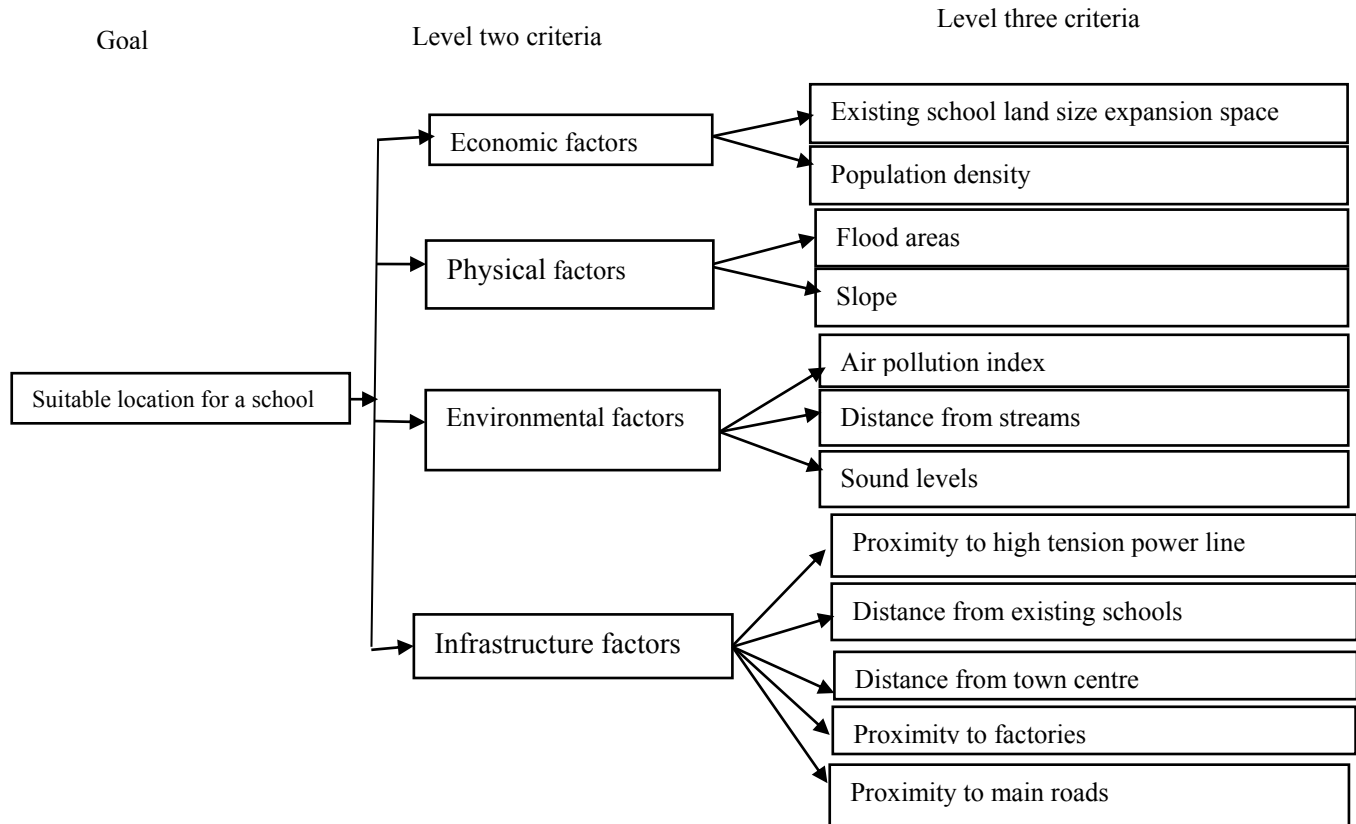

Fig.3: AHP ranking

### III. RESULTS AND ANALYSIS

#### A. School site selection model

The study led to development of a suitable site selection for a school. The model was developed in such a way that the criteria is loaded into the geodatabase and its percentage influence including the restricted zones due to its existence keyed in the model and running it to yield an output which is a map showing optimum sites for a school.

The model is run in steps that zeroes in towards the goal starting from inputting the spatial data and classification of it. Part of the model (Fig. 4) shows input as High voltage power line and it is converted to euclidean distance followed by reclassification and weighted overlay leads to identification of suitable site for a school.

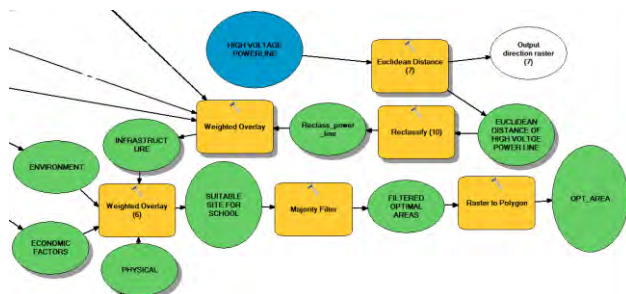

Fig. 4: Part of the model for suitable school site selection

#### B. Classified euclidean distances

The objective of the study is based on all analysis carried out and results are presented in form of maps and writing. A working model for suitable site selection for a school was developed from the twelve factors. The twelve layers were generated using ArcGIS software, Euclidean distance yielded a raster map with distance from the factors. They were then zoned (as illustrated in table 3-2) into four classes from restricted areas (1) to most suitable areas (4) according to proximity to factors generated via reclassify tools (Fig. 5 to Fig. 17). Of the 123 public schools 21 fell on private plantations meant for the workers children (Chemogonday sub location) and 44 Schools were found to be of land size less than 2.4 acres and were eliminated from participation of finding suitable site for a new school.

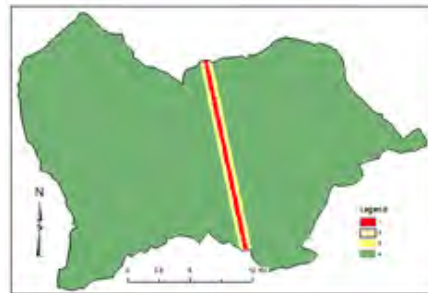

Fig. 5: Classification of distances to power line

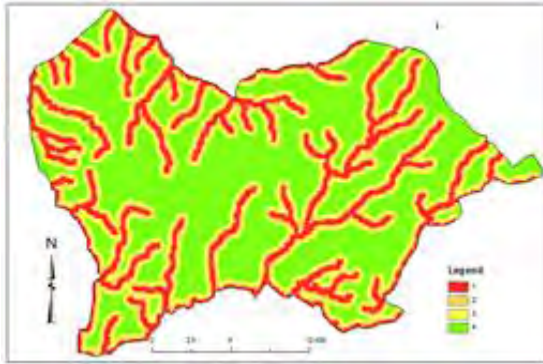

Fig. 6: Classification of distances to rivers

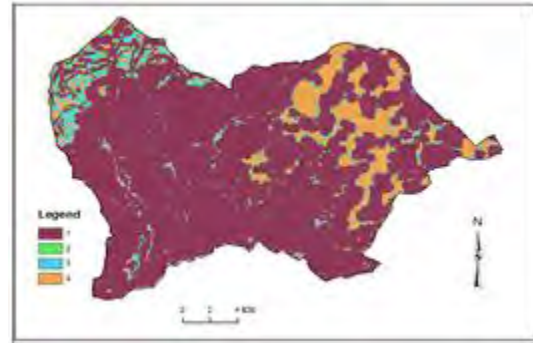

Fig. 10: Classified slope map



Fig. 7: classification of distances to main roads

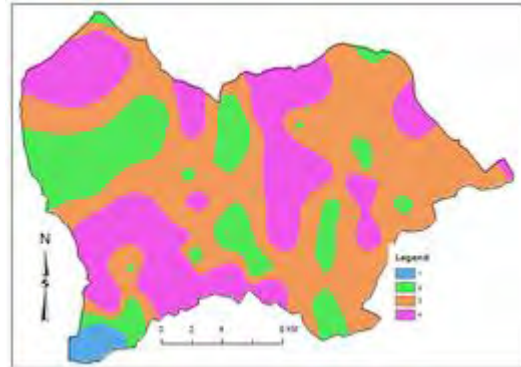

Fig. 11: Air Pollution Index map

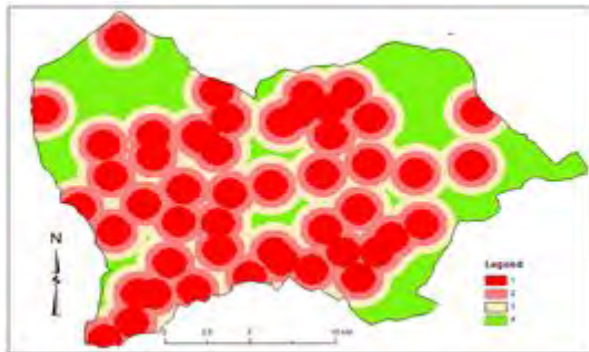

Fig. 8: Classified Euclidean distance to schools

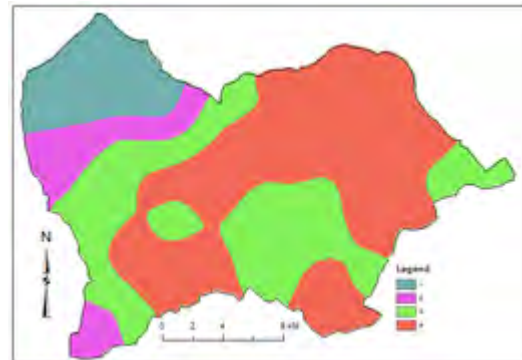

Fig. 12: Classified density map

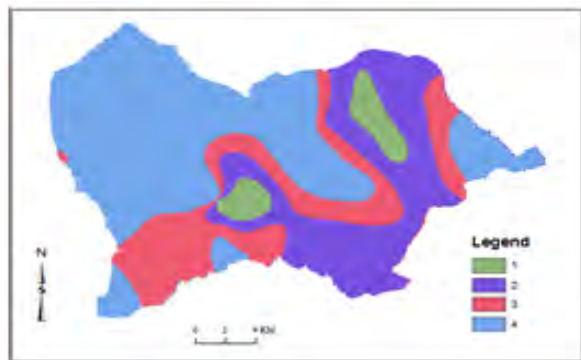

Fig. 9: Classified noise map

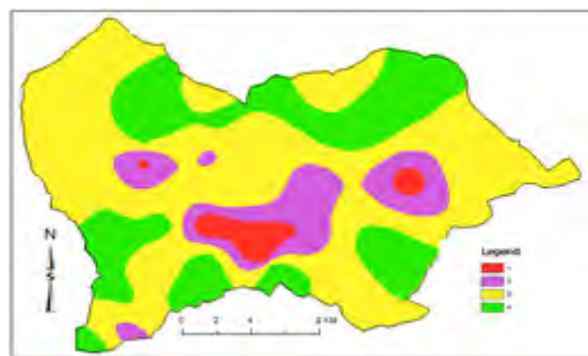

Fig. 13: Classification basing on available expansion space



Fig. 14: Classification basing on flood areas

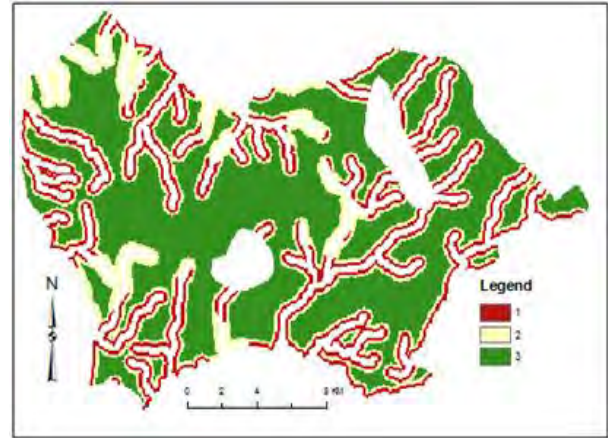

Fig.17: Weighted overlay of environmental factors



Fig.15: Classified euclidean distances to towns

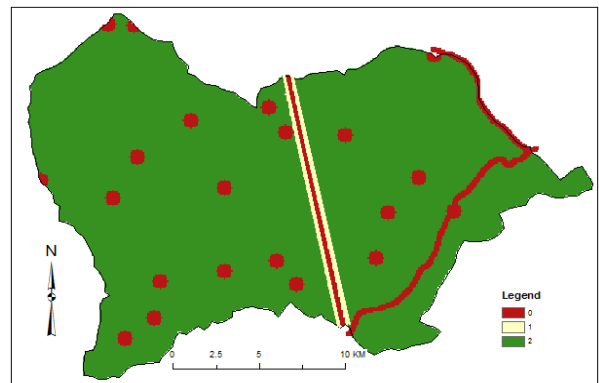

Fig. 18: Weighted overlay of infrastructures



Fig. 16: Euclidean distances to factory areas



Fig.19: Weighted Overlay of economic factors

### C. Weighted overlays

Weighted overlay for level 3 factors (Fig. 17-Fig 20) clipped the restricted areas and a map with three zones in order of suitability level were returned.

Overlay of level two factors (Fig. 21) returned two classes of areas, the unsuitable and the suitable areas which on filtering by eliminating the suitable areas with too small sizes, the optimum areas for most suitable site were obtained (Fig. 22).

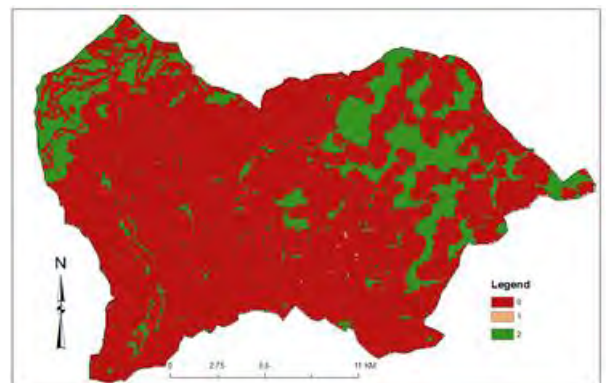

Fig.20: Weighted overlay of physical factors

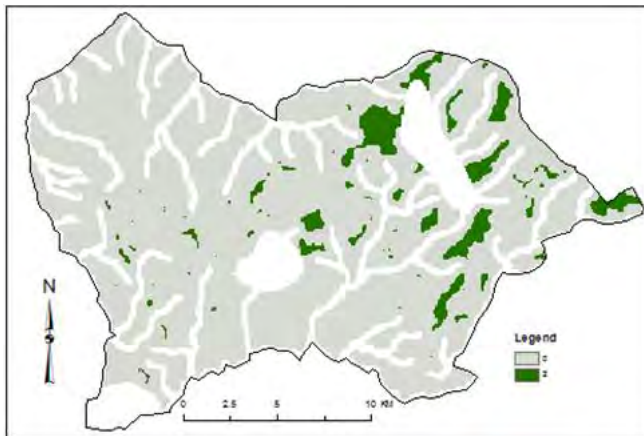

Fig. 21: Suitable locations for a school



Fig.22: Optimum filtered locations

#### D. Capabilities of the model

This model can be used in any place provided that a criteria is first done and loaded to a geodata base. By dragging into the model and running it will return a map of all available sites for a school. The model is designed in ArcGIS and it can be edited and modified to suit various criteria and levels of ranking. The model developed is for twelve criteria and three levels of hierarchy.

It is paramount to locate a school in a save place however economic factors are brought in for planning and forcasting and to serve the public efficiently. By in putting expected future factors that can have been interpolated , planners can use the model for the future schools that may emerge due to population increase and emerging infrastructures.

#### E. Available suitable sites

32 ha were found to be in suitable places at the Eastern part of the constituency and the central part with very small area to the South western part of the constituency. This space can accomodate over 32 streams of 320 pupils each translating to a total of 10 240 pupils.

A check on this locations indicated that indeed some nine schools are located in them but are either in land size of less than 2.4 or are over populated and without space for expansion. while others (35) fell on the unsuitable sites.

Results indicated that Sosiot, Kipkoyan, Kaptoboiti and Borborwet sublocation have the most suitable site for a new

school based on all the twelve criteria this is due to high population density, fairly flat terrain and that schools around this place are already full with little or no room for expansion.

## IV. CONCLUSIONS AND RECOMMENDATIONS

### A. Conclusions

The existing schools were captured and put to a database in a personal geodatabase along with other feature and raster class data that made the criteria used to determine the optimal sites of a school. The methodology employed integration of GIS technology and AHP as an MCE tool to support decision making on school location.

There were 44 schools in the study area that had less than 2.4 acres of land for a single stream implying they were initiated without prior consideration of minimum size required. The results indicated that there are areas that are suitable and economically viable to add new schools to the eastern part of Belgut which totals to 32 Ha with a small part falling in the central and south western part. There were no systematic criteria for a school location and hence the model was developed basing on the experts' opinion and sourced from literature review. The model can reduce, incidences of congested, dangerous locations, underutilized schools and human bias will be eliminated.

### B. Recommendations

Decision makers need to embrace this technology as is suggested in the Kenya vision 2030 and the role of GIS in meeting its goals, since it provides a scientific way of decision making and promotes fairness.

The weighted overlay successfully yielded logical results and can be used for similar research in future and can be incorporated into the Ministry of Education's school mapping project provided it is updated in a desired regular interval of time.

There is need for further research on education facility location to piece up the necessary locational criteria in Kenya so that site for new schools can be selected systematically and in a scientific method. A mechanism need be created to stop cropping up of new schools that do not meet the recommended standards like minimum land size and unsuitable locations.

## ACKNOWLEDGEMENTS

To Kericho County and Kericho West District education offices, thank you for giving access to your data. I am also greatly indebted to various authors whose publications I have used as references. I commend them for their superb work, which have enabled me to conceptualize the methodology of this research project.

## REFERENCES

- [1] Osman K., N. Bojčetić and D. Marjanović Dubrovnik, (2010) Multi criteria decision making in product platform development and evaluation, international design conference
- [2] Republic of Kenya (1995). District Focus For rural Development. Nairobi: Government printers.
- [3] Republic of Kenya (2007). Kenya vision 2030. Nairobi: Ministry of planning and National development.
- [4] Craig Helen and Wamalwa Fredrick (undated) Wealth and Wellbeing: Shaping Kenya's Road to Prosperity, Policy note for new government. The World Bank Group. <http://www.vision2030.go.ke/cms/vds/KE> Policy Notes Synthesized Report Accessed 8/7/2014.
- [5] Ministry of Education (2008). Safety Standards Manual for schools in Kenya (1st edition). Nairobi: Government printers.
- [6] Edemba (2012) The role of Geospatial Technology (GIS) in the Kenya Vision 2030. <http://edembac.wordpress.com/2012/12/29/the-role-of-geospatial-technology-gis-in-the-kenya-vision-2030/>. Accessed 8/7/2014
- [7] James, A. LaGro, (2001) Analysis; linking programs and concepts in land planning and design. John Wiley and sons, Inc.
- [8] Sudabe Jafari and Narges Zaredar (2010) Land Suitability Analysis using Multi Attribute Decision Making Approach.
- [9] Khalid, E. (2013), Faculty of Computers and Informatics, Zagazig University, Egypt. The International Arab Journal of Information Technology, Vol. 10, No. 3. Technology, University Putra Malaysia 43400 Serdang, Selangor, Malaysia.
- [10] Bukhari, Z., Rodzi, A. M., Noordin, A. (2010) Spatial multi-criteria decision analysis for safe school site selection, Spatial and Numerical Modeling Laboratory, Institute of Advanced
- [11] Gituto, B.M. (2007) Beyond CDF, Making Kenya's Sub-Sovereign Finance Work for the Socially-Excluded, Nairobi. (Heinrich Boll Foundation-2007). Edited by Heinrich Boll Foundation
- [12] Koikai, Joan.S. (2008). Utilizing GIS-based suitability modeling to assess the physical potential of bioethanol processing plants in Western Kenya. Retrieved from <http://www.gis.smumn.edu/GradProjects/KoikaiJ.pdf>.
- [13] Republic of Kenya (2006) mini Lake Victoria environmental management project phase ii preparation assessment of the potential of land suitability mapping with environmental overlays and potential usefulness of spatial planning for managing the Lake Victoria basin. Nairobi, Kenya.
- [14] Malczewsk, J. (2004). GIS-based land-use suitability analysis: a critical overview. Progress in Planning 62 (2004) 3-65.
- [15] Saaty, T. (1977). A scaling method for priorities in hierarchical structures. Journal of Mathematical Psychology, 15, 234-281.
- [16] Taylor, B. W., (2004), Introduction to Management Science, Pearson Education Inc. New Jersey.
- [17] Ishizaka, A and Labib, A. (2011) Review of the main developments in the analytic hierarchy process, Expert Systems with Applications, University of Portsmouth, Portsmouth Business School, Richmond Building, Portland Street, Portsmouth PO1 3DE, United Kingdom. Operational Research Society Ltd 0953-5543 OR Insight Vol. 22, 4, 201-220
- [18] Pan, N. (2009). Selecting an appropriate excavation construction method based on qualitative assessments. Expert Systems with Applications, 36, 5481-5490.
- [19] Golden, B., Wasil, E. and Harker P. (1989). The Analytic Hierarchy Process: Applications and Studies. Heidelberg, Germany. Springer-Verlag
- [20] Vargas, L. (1990) An overview of the analytic hierarchy process and its applications. European Journal of Operational Research.
- [21] Saaty, T.L., (1994), Fundamentals of Decision Making and Priority Theory with the Analytical Hierarchy Process, RWS Publications, Pittsburgh
- [22] Zahedi, F. (1986) The Analytic Hierarchy Process: A survey of the method and its applications. Interface 16(4): 96-108.
- [23] Kumar, S. and Vaidya, O. (2006) Analytic hierarchy process: An overview of applications. European Journal of Operational Research 169(1): 1-29.
- [24] Omkarprasad, V. and Sushil, K. (2006) Analytic hierarchy process: An overview of applications. European Journal of Operational Research.
- [25] Shim, J. (1989) Bibliography research on the analytic hierarchy process (AHP). Socio-Economic Planning Sciences 23(3):161-167.
- [26] Saaty, T., & Forman, E. (1992). The Hierarchon: A Dictionary of Hierarchies (Vol. V). Pittsburgh: RWS Publications.
- [27] Tasha, H. A., (2003), Operations Research, Pearson Education Inc., Fayetteville.
- [28] Pohekar, S. D., and Ramachandran, M., (2004), Application of Multi-Criteria Decision Making to Sustainable Energy Planning A Review Renewable and Sustainable Energy Reviews, 8, 365-381.
- [29] Cheng, C. H., Yang, K. L., and Hwang, C. L., (1999), "Evaluating Attack Helicopters by AHP Based on Linguistic Variable Weight", European Journal of Operational Research, 116, 423-435.
- [30] Saaty, T L (1980). The Analytic Hierarchy Process. Planning, priority setting, resource allocation. McGraw Hill, New York.
- [31] School facility planning Division, (2007) School Site Selection and Approval Guide. California. <http://www.cde.ca.gov/ls/fa/sf/documents/ssad.pdf> accessed 10/10/2014
- [32] The environmental management and coordination (noise and excessive vibration pollution) (control) regulations, (2009). Retrieved September 6, 2014 from <http://www.google.com/url?~bv.80185997,d.d2s>.
- [33] United States Environmental Protection Agency. (2011) Air Quality Index - A Guide to Air Quality and Your Health". US EPA. <http://www.airnow.gov/index.cfm?action=aqibasics.aqi> Retrieved 8/6/2014.
- [34] Kenya power and lighting. (2009) Updated Environmental and Social Impact Assessment Report for the Proposed Mombasa Nairobi 400kv Transmission Line plc/17abmsa nbi400kv/tl.



# Statistical Comparison of Experts' Responses in a GIS-AHP Oil Pipeline Route Optimization

Macharia Peter M, Charles N Mundia and Miriam Wathuo

**Abstract**—Analytical Hierarchical Process (AHP) method relies on expert responses to get a decision maker's point of view which is fundamental to the credibility and the quality of the results. Do we know what experts take into consideration when they give responses? How does the decision maker's knowledge influence the decision that he makes? While it seems logical that opinions should be sought from diverse experts in a Geographical Information Systems based oil pipeline routing using AHP, is it an assumption that should be made? Do experts in the same area of expertise give similar opinions as a group or do they give individual responses irrespective of their profession?

This study analyzed weights of 13 variables derived using AHP in GIS based pipeline routing process from six expert groups comprising of civil engineers, environmentalists, county administrators, local people, oil industry experts and geoinformation experts. Comparison of responses was done among experts of the same group and between groups using the spearman's rank correlation coefficient, while visual comparison of the responses was done using scatter plots and bar graphs.

Out of the six groups of experts, geoinformation specialists and county administrators gave closely related responses among themselves, while the rest gave relatively varied responses. It can be shown that experts thought rationally while giving responses and did not respond based on their professional knowledge. Further it was shown that there was little correlation among the six groups. Therefore, it was concluded that responses should be sought from different groups of experts but with expertise required in pipeline routing. However, caution should be given to experts to respond based on their professional knowledge. If caution is not taken, the need for seeking responses from different groups of experts loses its meaning.

**Keywords**— AHP, Experts response, GIS, Pipeline routing, Statistical Analysis, Variation

## I. INTRODUCTION

There are various variables considered in a pipeline routing process. Therefore it is necessary to rank each variable in order of importance. This helps determine the amount of influence each variable has on the routing process. The GIS approach to pipeline routing optimization is based on relative rankings and weights assigned to project specific factors that may affect the potential route. The result of this process is an

optimal path which maps out that most economic path between the start and the destination points of the pipeline [1]. The factors influencing pipeline route selection are technical and engineering requirements, environmental considerations, and population density [2].

AHP is *multi criteria decision* making method originally developed in 1980. It is a quantitative method for decision ranking which involves making alternatives by developing a numerical score to rank each decision alternative based on how well each alternative meets the decision maker's criteria [3]. The process aids in the solution of complex multiple criteria problems in a number of application domains.

In AHP, one constructs hierarchies then performs measurements on pairs of elements with respect to a control element to obtain ratio scales which are then incorporated into the whole structure to select the best alternative. The ratio scales are derived from the principal Eigen vectors and the consistency index is derived from the principal Eigen value [4]

This study analyses the results of weights derived from an oil pipeline routing using AHP and GIS. The routing process and the results has been described elsewhere [12].

### A. AHP in Practical Use

Various research work has been carried out using Multi-criteria decision Analysis (MCDA) AHP method. A research was done in Malaysia's oil rich Baram field integrating GIS and Multi-criteria decision Analysis in optimal oil pipeline route selection. [5]. AHP together with GIS was used in pipeline routing. The AHP model was modified and the results showed that it scores over the conventional method of gathering pair wise comparisons [6].

Bunruamkaew conducted a study done in Thailand to identify and prioritize the potential ecotourism site in Surat Thani province, using GIS and AHP [7]. In order to explore the use of AHP in selecting an appropriate irrigation method in four provinces of Iran a study was carried out. A sample of farmers was separated into four groups using cluster analysis [8]. A combined AHP and Fault Tree Analysis (FTA) to support the design, construction, inspection and maintenance policy of oil and gas pipelines was done. This was accomplished by proposing an optimal selection strategy based on the probability and consequences of failure [9]. AHP is being continually being used studies to rank alternatives.

Macharia Peter M, School of Pure and Applied Sciences, Pwani University, phone: +254711170493; e-mail: [mwangi.peter53@gmail.com](mailto:mwangi.peter53@gmail.com)  
Charles N Mundia, Institute of Geomatics, GIS and Remote Sensing, Dedan Kimathi University of Technology, e-mail: [charlesndegwam@yahoo.com](mailto:charlesndegwam@yahoo.com)  
Miriam Wathuo School of Pure and Applied Sciences, Pwani University, email: [wathuo.miry@gmail.com](mailto:wathuo.miry@gmail.com)

### B. AHP inconsistencies studies

Nevertheless, many researches are continually being done to understand the inconsistencies that arise when AHP method is used. A method was proposed for a quantitative estimation of the decision maker's knowledge in the context of the AHP in cases where the judgment matrix is inconsistent [4].

Dong et al derived two consensus indexes for AHP to help decision makers reach consensus and provide more convincing alternatives. These are the geometric cardinal consensus index and the geometric ordinal consensus index, to measure consensus degree among judgment matrices or decision makers [10]. Lin et al, introduced uncertainty theory to deal with non-deterministic factors in ranking alternatives. The uncertain variable method and the definition of consistency for uncertainty comparison matrices were proposed. An approach for testing whether or not an uncertainty comparison matrix is consistent was put forward. AHP was examined to illustrate the validity and practicality of the proposed methods [11].

More researches are continually being carried out to understand any inconsistency in AHP method. Very few, if any, researches have been done to understand the variation of experts' responses in group responses and the rationale of such groups. This research aims to understand the variation of experts' responses in a group and among groups to improve the credibility of decisions made.

## II. METHODOLOGY

### A. Study area and Datasets

The study area extended between 0°51'N and 1°7'S and approximately between 38°36' E and 35°18' E. It bounded the counties of: Laikipia, Nyeri, Nyandarua, Meru, Nakuru and parts of Isiolo in Kenya shown in Figure 1a below.

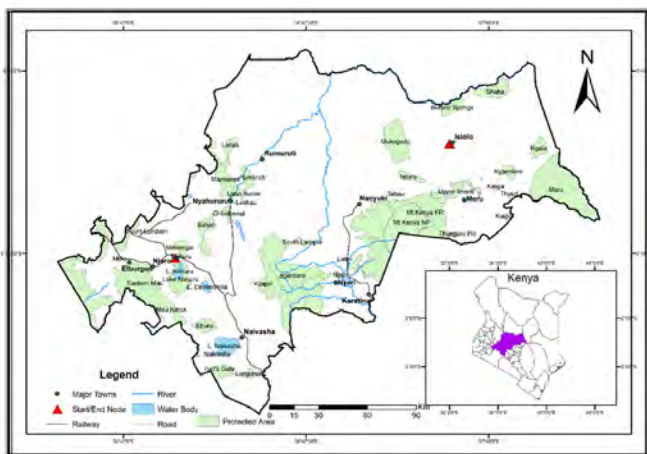

Figure 1a: Study area

The primary dataset used was the weights derived from experts' response using the AHP method [12]. The different groups of experts were chosen so as to have a holistic representation of professionals used in oil pipeline routing process.

### B. Method

Using the variables applicable in routing a pipeline in a typical Kenyan landscape, a study was carried out using AHP method to rank the variables from six groups of experts. These results were further analyzed statistically to detect the similarities and variations in each group of experts and among the groups in order to assess the need to seek opinions from experts of different fields. The methodology used to gather responses is depicted in the Figure 1b below.

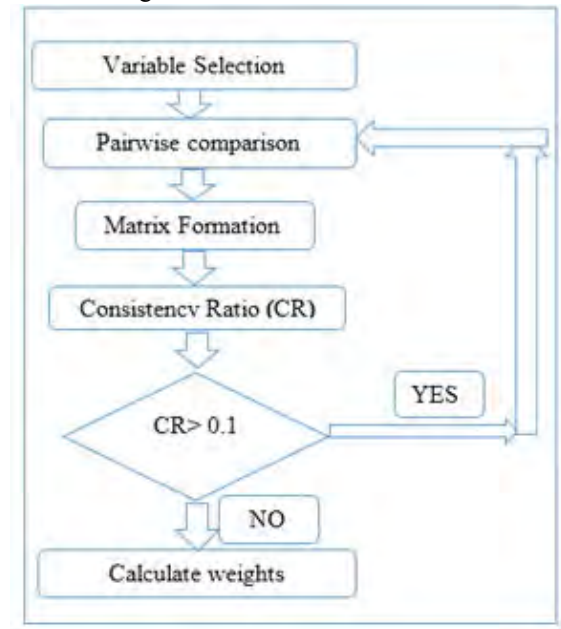

Figure 1b: Flow chart for AHP weighting

Variable selection was done at data collection point. Thirteen variables were selected [12] and used to form the pairwise comparisons according to Saaty's 9 point scale [14]. Questionnaires (32) were used to get feedback from different experts, a matrix formed and the consistency ratio calculated. A matrix for each respondent was formed in order to calculate the weights and the consistency ratio. If the consistency ratio was acceptable weights were calculated. Otherwise, the pairwise comparison was redone. The resultant weights were used for the statistical analysis.

Statistical analysis was done using Stata 13 (StataCorp US). Spearman's correlation coefficient and the resultant p-values, scatter plots and bar graphs were used to analyze the relationship between responses of experts within the same group and between different groups. The confidence level assumed was 95%, thus, a p-value less than 0.05 meant rejecting the null hypothesis that responses being tested were uncorrelated. For positive correlation, the closer the value was to 1, the stronger the correlation between the responses of the two experts. A negative correlation is a sign of an inverse relationship between two variables. In this study, a negative correlation between the responses of two experts meant that for most of the variables that one expert rated highly, the other one gave them a low rating. Thus, the closer the correlation was to -1, the more the two experts were considered to differ

in their thinking.

### III. RESULTS AND DISCUSSION

The results are presented in terms of each group of experts and comparison between the groups. Table 1 gives the

TABLE I  
VARIABLES USED IN THE STUDY

Number	Type
1	Proximity to settlements
2	Game parks/reserves/forest
3	Wetlands/lakes
4	Groundwater Sites
5	River Crossing
6	Agricultural Land
7	Slope
8	Geology
9	Rail crossing
10	Road crossing
11	Roads proximity
12	Bare land
13	Soil Type

variables that were used for this analysis and shows the order of the horizontal axis of the graphs in Figure 2, 4, 6, 10, 12 and 15.

#### A. Geoinformation Experts

The experts who formed part of the respondents in this category were; surveyors, GIS and Remote sensing experts and Geomatic engineers. Using the results of the consistent experts, environmental factors were rated as the most important followed by consequential factors, while engineering factors were considered least important. Bare land was considered insignificant with 2%. Figure 2 shows these variations. The standard deviation from the mean for the experts in this category has a maximum of 4.1% and a minimum of 2.3%. Variables 1, 2, 3 and 4 had wide ranges.

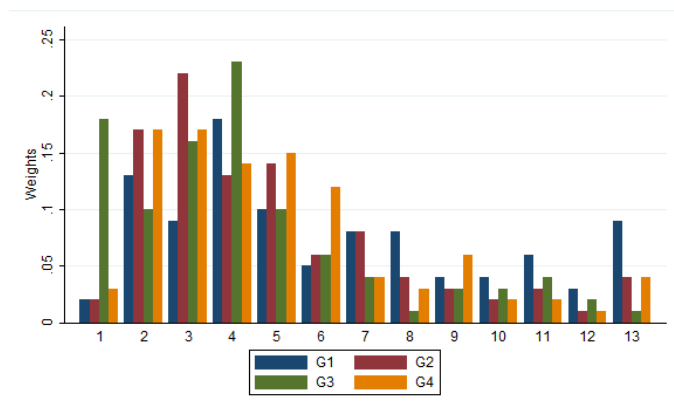

Figure 2: Geoinformation (G) weights

Using correlation coefficients, each expert's response were compared to the responses of other experts in the same category. Table 2 shows the correlation coefficients (r) and

the resultant p-values. All the experts' opinions had a good correlation, with the exception of the relationship between responses of experts 1 and 3, which was not statistically significant ( $p=0.0866$ ). The strongest correlation was observed between experts 2 and 4,  $r=0.91$  and the relationship was statistically significant ( $p=0.000$ ). This shows that this group of experts agreed among themselves and used their expertise knowledge in responding to the questionnaires. The scatter matrix in Figure 3 below shows these relationships.

In the scatter matrix in figure 2 below, relationships between each expert and all the experts in the geoinformation group is shown. G1 versus G2 (Geoinformation expert 1 versus Geoinformation expert 2) is shown by the intersection of G1

TABLE 2  
GEOINFORMATION EXPERTS

CORRELATION COEFFICIENTS				
	G1	G2	G3	G4
G1	1	0.69	0.49	0.66
G2	0.69	1	0.58	0.91
G3	0.49	0.58	1	0.6
G4	0.66	0.91	0.6	1
<i>p VALUES</i>				
p	G1	G2	G3	G4
G1		0.0092	0.0866	0.0139
G2	0.0092		0.0397	0
G3	0.0866	0.0397		0.0318
G4	0.0139	0	0.0318	

G1----G4= geo-information Expert 1-4

and G2. The intersection of a column and a row shows the relationship of the corresponding two experts. This applies in all the scatter matrix in this research.

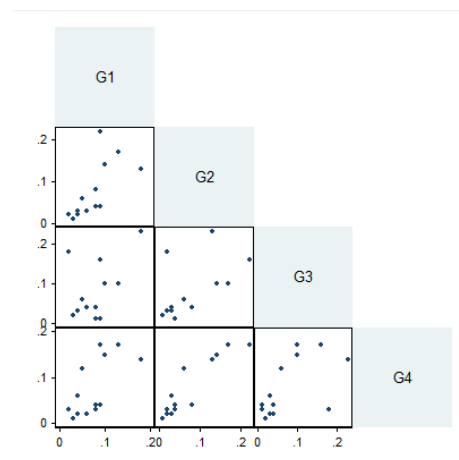

Figure 3: Scatter Matrix of Geoinformation (G) experts

#### B. Civil Engineers

The civil engineers consulted were those mainly involved in linear routing especially for pipelines and highways. The

consequential factors had high weights followed by environmental factors. Engineering factors that were considered as highly significant were slope and geology. The rest were given an almost an equal weight. The standard deviation from the mean were 7.9, 2.9, 3, 4.4 and 3 in terms of percentages. The high standard deviations signifies lack of consensus thus the mean attained results to a totally a new “individual” expert weight. This is mainly contributed by Engineer one who had a standard deviation of 7.9%. Figure 4 shows the variation in terms of weights by the engineers.

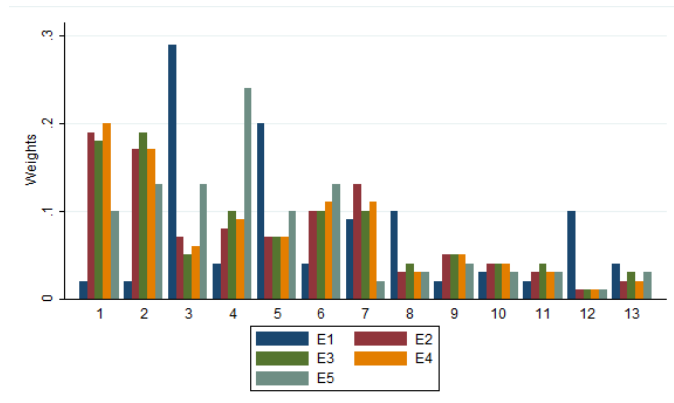

Figure 4: Variation of civil engineers (E) weights

Responses of Engineer one and five did not correlate with the rest, while there was correlation amongst engineers three, four and two. Ten comparisons were done in this category, with only three (30% of the comparisons) showing close relations ( $P < 0.05$ ). Table 3 shows p values and correlation coefficients(r) in Table 3. The results of comparisons are shown graphically by the scatter matrix in figure 5 below.

TABLE 3  
CIVIL ENGINEERS  
CORRELATION COEFFICIENTS

	E1	E2	E3	E4	E5
E1	1	-0.16	-0.28	-0.22	0.11
E2	-0.16	1	0.97	0.99	0.44
E3	-0.28	0.97	1	0.98	0.52
E4	-0.22	0.99	0.98	1	0.49
E5	0.11	0.44	0.52	0.49	1
<i>p VALUES</i>					
E1		E2	E3	E4	E5
E1		0.6053	0.3476	0.4709	0.725
E2	0.6053		0	0	0.1366
E3	0.3476	0		0	0.0683
E4	0.4709	0	0		0.0883
E5	0.725	0.1366	0.0683	0.0883	

E1----E5= Civil Engineer 1-4

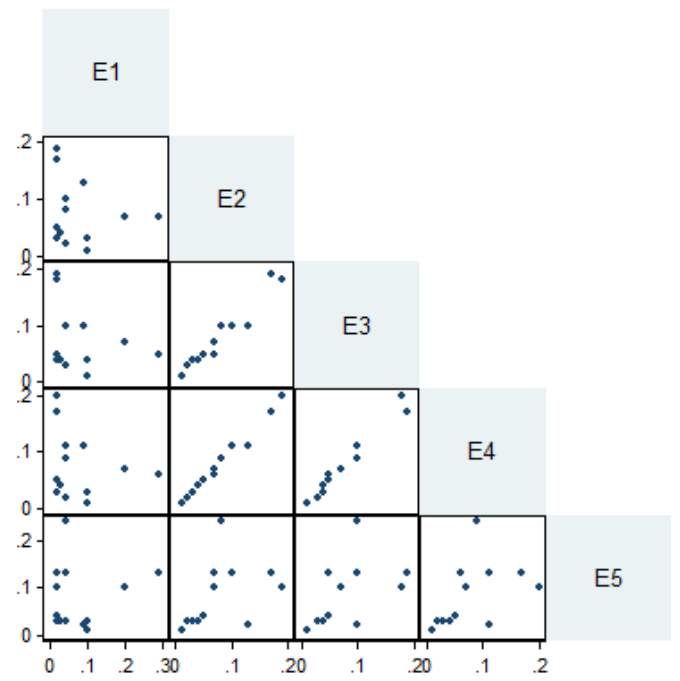

Figure 5: Scatter matrix of Civil Engineers

### C. County Administrators

County administrators consisted of individuals who were formerly chiefs, district officers and district commissioners. The consequential factors took precedence followed by environmental factors, with soil type also scoring a high precedence. Other engineering factors were given least precedence. All county administrators recorded almost equal standard deviation (3, 2.6 and 3) showing a high level of consensus thus the averaged weights were good balance between them.

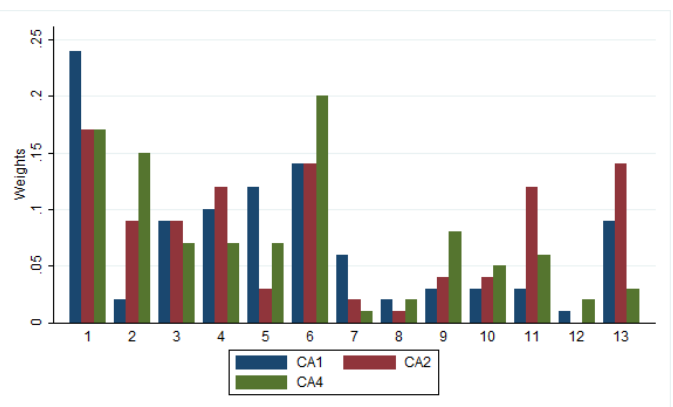

Figure 6: Weights variation by County Administrators

100% of the consistent county administrators' weights (80% of the respondents in this category), exhibited moderately high correlation coefficients, showing a good level of agreement among the administrators. All their p-values were < 0.05 leading to the conclusion that the relationship between all their responses were statistically significant, thus a good level of agreement among all the administrators. All the three comparisons done in this group (100%) showed high level of agreement as exhibited by Table 4 and scatter matrix in Figure 7.

TABLE 4  
COUNTY ADMINISTRATORS

CORRELATION COEFFICIENTS			
	CA1	CA2	CA4
CA1	1	0.66	0.59
CA2	0.66	1	0.64
CA4	0.59	0.64	1
<i>p</i> VALUES			
	CA1	CA2	CA4
CA1		0.0132	0.0346
CA2	0.0132		0.018
CA4	0.0346	0.018	

CA1----CA3= County Administrators 1-4

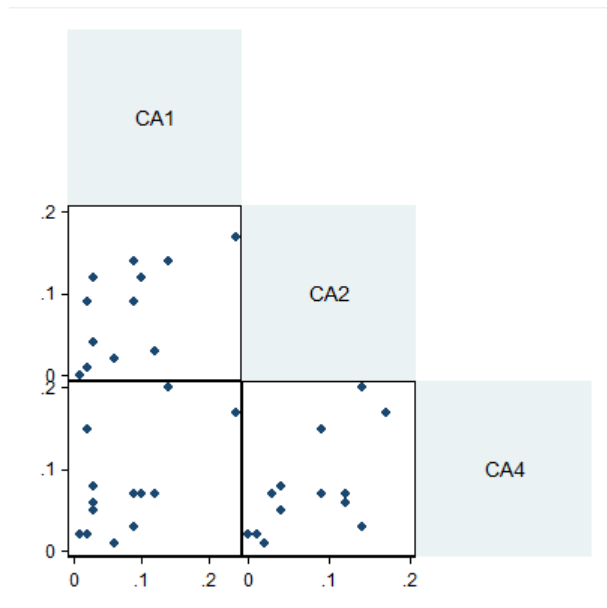

Figure 7: Scatter matrix for county administrators

#### D. Local People/Residents

People who were local to the study area, and who did not necessarily have a specific area of specialization were also consulted. As expected there was strong preference for settlements. This may be explained by the fact that they value

their areas of residence and would not like to be affected by oil pipeline accidents. However, there was no specific trend in terms of what category was favored most. This can be attributed to the fact that while a person may be a resident of a particular county, their angle of thinking might not be that of a county resident. This is further supported by the high standard deviation between the different respondents in this category (5.3, 5.2, 6.5, 4.0 and 6.4)

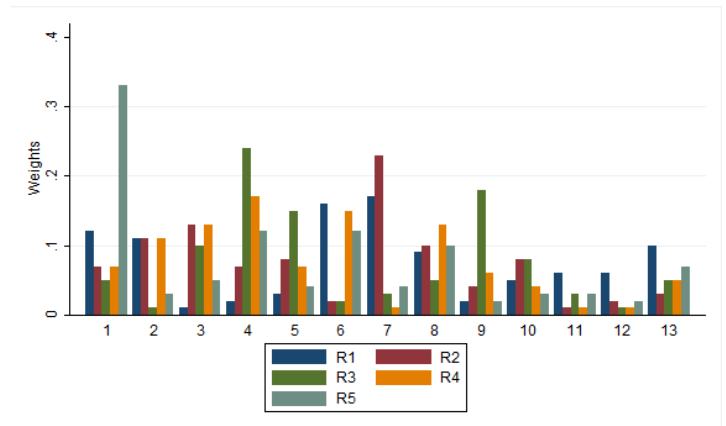

Figure 8: Variation of Locals response

From the correlations Table 5, it is clear that the all locals had different opinions with regard to pipeline routing, and no two locals had a similar opinion. The negative correlations points out the glaring differences in opinion between the locals. The scatter matrix in Figure 9 shows that the variables have no relationship. Ten comparisons were done in this group, with 0% of the comparisons having closely related opinions between the experts.

TABLE 5  
LOCALS/ RESIDENTS

CORRELATION COEFFICIENTS					
	R1	R2	R3	R4	R5
R1	1.00	0.27	-0.69	-0.10	0.32
R2	0.27	1.00	-0.04	0.00	-0.07
R3	-0.69	-0.04	1.00	0.38	-0.02
R4	-0.10	0.00	0.38	1.00	0.29
R5	0.32	-0.07	-0.02	0.29	1.00
<i>p</i> VALUES					
	R1	R2	R3	R4	R5
R1		0.37	0.01	0.74	0.29
R2	0.37		0.91	0.99	0.83
R3	0.01	0.91		0.21	0.96
R4	0.74	0.99	0.21		0.34
R5	0.29	0.83	0.96	0.34	

R1----R5= Resident 1-4.

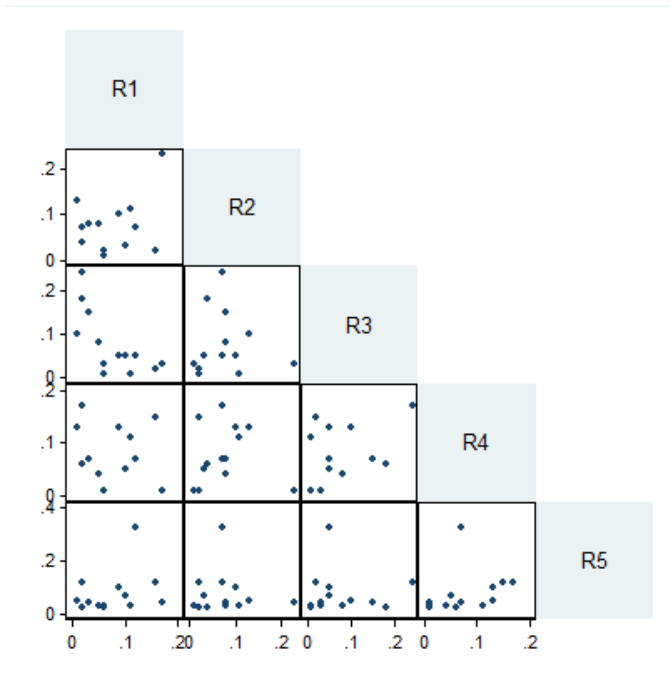

Figure 9: Scatter matrix for residents.

#### E. Environmentalists

Environmental factors were highly rated as was expected. This is shown in Figure 10, with slope and settlements also falling in this category. The rest of the engineering factors were lowly rated. The standard deviation in this category was high (5.1, 5.7, 5.1 and 3.9). This might have been brought by the fact that the experts never agreed on how high to rate an environmental factor or how low to rate an engineering factor.

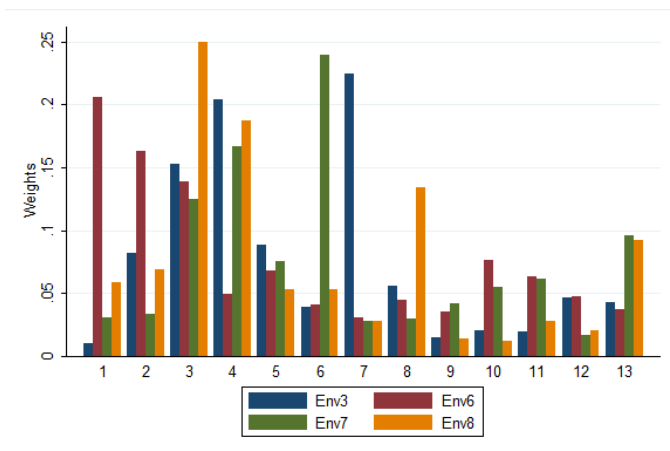

Figure 10: variation of weights by Environmentalist

Among the group of consistent environmental experts 4 (50%), the comparison of all the environmentalists' responses had very low correlation coefficients, and the p-values also showed that neither comparison of responses had a statistically significant relationship. The p values and correlation coefficients are shown in Table 6. The scatter

matrix in Figure 11 below shows the variations between the responses. Six Comparisons were made, with 0% of the comparisons showing high correlations.

TABLE 6  
ENVIRONMENTAL EXPERTS

CORRELATION COEFFICIENTS				
	Env3	Env6	Env7	Env8
Env3	1	-0.14	0.19	0.53
Env6	-0.14	1	-0.22	0.21
Env7	0.19	-0.22	1	0.39
Env8	0.53	0.21	0.39	1
<i>p</i> VALUES				
	Env3	Env6	Env7	Env8
Env3		0.6428	0.527	0.0648
Env6	0.6428		0.4692	0.4819
Env7	0.527	0.4692		0.191
Env8	0.0648	0.4819	0.191	

Env = Environmental Experts

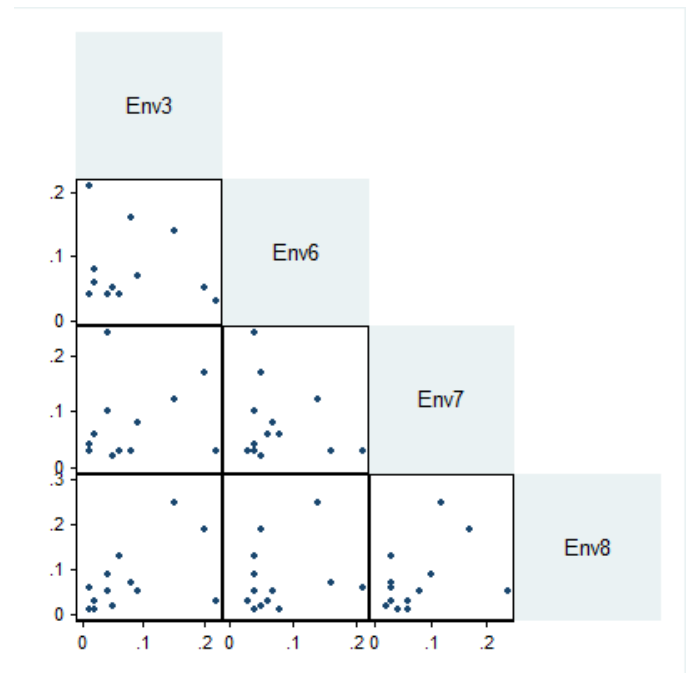

Figure 11: Scatter matrix for Environmentalist

#### F. Oil and Pipeline

This was the category in which the consistency ratio performed the worst, as only 40% were consistent. There is no specific trend of which category of factors were given more or less precedence as shown by Figure 12. The balance stricken between the two experts in this category creates a different expert since there is very little correlation between their individual categories. The correlation coefficient obtained is -

0.28 (p=0.362). The high standard deviation of 5.2% a piece further supports this argument. Ranges of up to 23% recorded prove that the two respondents' responses were completely different (p=0.362, which is much greater than 0.05). The scatter plot in figure 13 below emphasizes this claim.

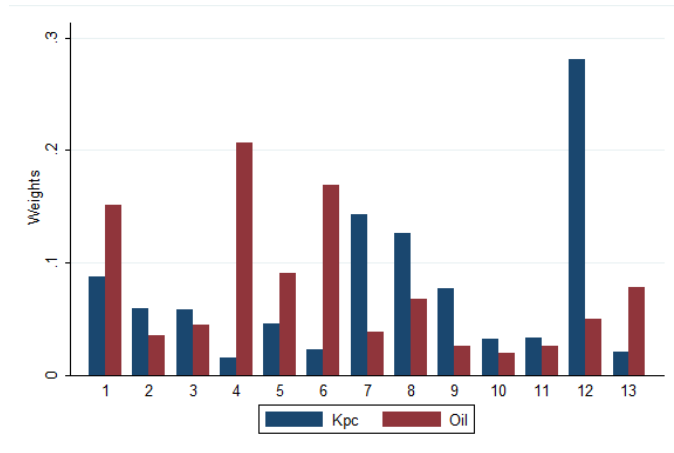

Figure 12: weights variation by Oil/Pipeline experts

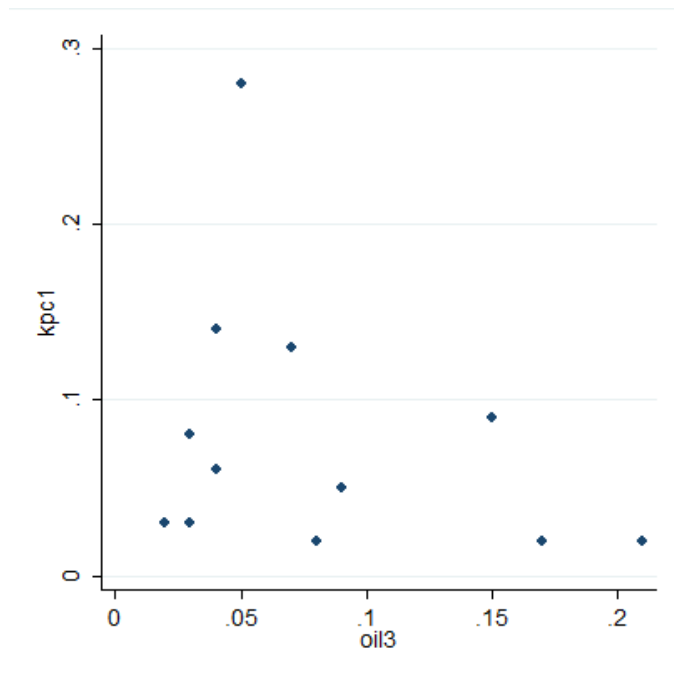

Figure 13: Scatter plot for oil experts

### G. Groups Comparison

A comparison of the various categories of the group of experts is shown by Figure 15. Various factors had a unanimous agreement based on their percentages on their contribution to routing. Road crossings, road proximity and rail crossings all averaged to least rated. For the bare land only the oil experts differed with the rest. Ground water sites, slope, game parks and agricultural land had majority of experts giving similar percentages. Settlements, geology and wetlands were seen to

have varying percentages.

The correlation coefficients and p values are shown in table 7. Oil experts had very different opinions from other experts, they had very low correlation and were not significant (p>0.05). Civil engineers had very high correlation with rest of the experts except oil group. The environmentalists, had moderated correlation with other experts, while Geoinformation experts, county administrators and locals/residents showed low correlation. The fact that there was generally low correlations between the groups indicates that it is valid to have group responses so as to have diverse opinions across the board.

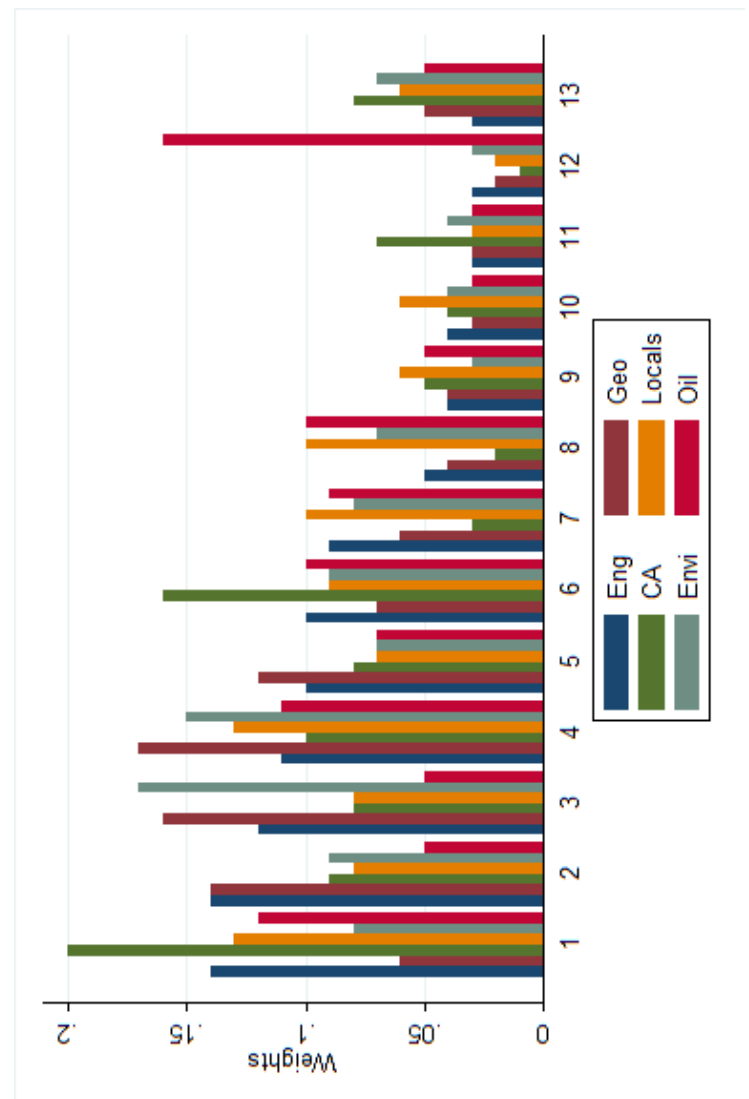

Figure 15: A comparison of various categories of weights

TABLE 7  
GROUP ANALYSIS

CORRELATION COEFFICIENTS						
	Eng.	Geo	CA	Loc	Envi	Oil
Eng.	1	0.75	0.65	0.71	0.69	0.16
Geo	0.75	1	0.31	0.49	0.87	-0.07
CA	0.65	0.31	1	0.54	0.36	0.11
Loc	0.71	0.49	0.54	1	0.62	0.27
Envi	0.69	0.87	0.36	0.62	1	0.05
Oil	0.16	-0.07	0.11	0.27	0.05	1

p Values						
	Eng.	Geo	CA	Loc	Envi	Oil
Eng.		0.0029	0.0162	0.0066	0.0088	0.6107
Geo	0.0029		0.3096	0.0917	0.0001	0.8217
CA	0.0162	0.3096		0.0558	0.2295	0.726
Loc	0.0066	0.0917	0.0558		0.0248	0.3706
Envi	0.0088	0.0001	0.2295	0.0248		0.8798
Oil	0.6107	0.8217	0.726	0.3706	0.8798	

Eng= Civil Engineer 1-4; CA= County Administrators; Envi= Environmentalist; Geo= Geoinformation Experts; Loc=Locals/Residents

#### IV. CONCLUSION

The responses given by experts in a pipeline routing process using GIS and AHP are used to influence decisions made by policy makers. Therefore, the nature of the responses contributes directly to the credibility and the quality of the decision made. How does a respondent's knowledge influence the decision he makes? Do experts of same area of expertise give similar opinions as a group or do they give individual responses irrespective professional background?

Geoinformation experts gave closely related responses amongst themselves, while the civil engineers had varied responses amongst themselves. The county administrators, on the other hand, all had closely related responses.

The oil and pipeline experts, environmentalists, and the locals gave varying responses in their respective groupings showing that they had very different opinions on the variables that matter in pipeline routing. The analysis of the averages of the groups showed that there was little correlation between the groups. This shows how differently these groups of experts rank the variables of interest.

From this analysis, it was concluded that most experts from the same group of expertise did not give responses based on their professional background. Otherwise, high correlation would have been observed in almost all groups. How a respondent's knowledge influences the decision he makes is determined by: whether he uses his expertise knowledge or uses rational and logical thinking to give a response. It was further observed that there was little correlation between the groups of professionals. This supports the claim that responses should be sought from different groups of experts since they give varying opinions as "groups". However, there was no

correlation among experts of the same group/profession possibly due to professionals not using their expertise knowledge and opting for rational and logical thinking.

It is concluded that experts should respond based on their professional knowledge. If caution is not taken, the need for seeking responses from many experts in a group and consequently different groups of experts loses its meaning.

It is recommended that further studies should be carried out, before and after cautioning the experts. The analysis of results from these studies would give more insight on whether it is best to consider group or individual responses.

#### ACKNOWLEDGEMENT

Macharia Peter thanks, Victor Wahome, Paul Ouma and Kenneth Mwangi for their comments on earlier versions of this manuscript.

#### REFERENCES

- [1] G. Henley and H. Dresp, "Pipeline Route Selection Process," Pipeline Route Selection Process, 2012. [Online]. Available: [wiki.iploca.com/display/rtswiki/Appendix+5.1.1](http://wiki.iploca.com/display/rtswiki/Appendix+5.1.1). [Accessed: 20-Mar-2013].
- [2] S. C. Feldman, R. E. Pelletier, E. Waker, J. C. Smoot, and D. Ahl, "A Prototype for Pipeline Routing Using Remotely Sensed Data and Geographic Information System Analysis," vol. 4257, no. 95, 1995.
- [3] T. L. Saaty, "Decision-making with the AHP: Why is the principal eigenvector necessary," Eur. J. Oper. Res., vol. 145, pp. 85-91, 2003.
- [4] A. Szczypińska and E. W. Piotrowski, "Inconsistency of the judgment matrix in the AHP method and the decision maker's knowledge," Phys. A Stat. Mech. its Appl., vol. 388, no. 6, pp. 907-915, Mar. 2009.
- [5] A. Balogun, A. Matori, D. U. Lawal, and I. Chandio, "Optimal Oil Pipeline Route Selection using GIS: Community Participation in Weight derivation and Disaster Mitigation," Int. Conf. Futur. Environ. Energy, vol. 28, pp. 100-104, 2012.
- [6] K. S. Suresh and C. N. Nonis, "Investigation of an AHP based Multi Criteria Weighting Scheme for GIS Routing of Cross Country Pipeline Project," in 24th International Symposium on Automation & Robotics in Construction, 2007.
- [7] K. Bunruamkaew, "Site Suitability Evaluation for Ecotourism Using GIS & AHP: A Case Study of Surat Thani Province, Thailand Site Suitability Evaluation for Ecotourism Using GIS & AHP: A Case Study of Surat Thani Province," 2012.
- [8] E. Karami, "Appropriateness of farmers' adoption of irrigation methods: The application of the AHP model," Agric. Syst., vol. 87, no. 1, pp. 101-119, Jan. 2006.
- [9] J. V. Alex. W. Dawotola, P.H.A.J.M van Gelder, "Risk Assessment of Petroleum Pipelines using a combined Analytical Hierarchy Process - Fault Tree Analysis," in Proceedings of the 7th International Probabilistic Workshop, 2009, no. 2006, pp. 491-501.
- [10] Y. Dong, G. Zhang, W.-C. Hong, and Y. Xu, "Consensus models for AHP group decision making under row geometric mean prioritization method," Decis. Support Syst., vol. 49, no. 3, pp. 281-289, Jun. 2010.
- [11] L. Lin and C. Wang, "On consistency and ranking of alternatives in uncertain AHP \*," Nat. Sci., vol. 4, no. 5, pp. 340-348, 2012.
- [12] P. M. Macharia and C. N. Mundia, "GIS Analysis and Spatial Modelling for Optimal Oil Pipeline Route Location: A Case Study of Proposed Isiolo Nakuru Pipeline Route," Int. J. Sci. Res., vol. 3, no. 12, pp. 1227-1231, 2014.
- [13] T.L. Saaty, The Analytic Hierarchy Process, McGraw-Hill, New York, 1980



# Synchronous and Induction Machine Based Distributed Generation Islanding Detection: An Overview

L. Mogaka, D. K. Murage, M. J. Saulo and S. Kariuki

**Abstract** - The increased use of distributed generation in the power system due to increased load demand has brought about many benefits to the power grids. This is due to the concerns about whether the technology in use currently in power generation and distribution, is sufficient to cover the future increasing demand with the limited supply. In response to this problem of increased load demand, efforts have been made to decentralize this infrastructure through the use of distributed generators. The benefits of using distributed generation include; improved reliability and increased efficiency in power supply, avoidance of transmission and distribution capacity upgrades, improved power quality and reduced line losses among others. Despite these advantages, un-intentional islanding remains a big challenge and has to be addressed in integration of Distributed Generation to the power system. Unlike inverter based distributed generators, Synchronous generators with fast response governors and AVRs are highly capable of sustaining an island. Therefore, anti-islanding protection for synchronous generators is a more challenging problem in comparison with the inverter-based DG. This paper reviews the various methods currently used in islanding detection especially for synchronous and induction generators.

**Keywords:** Distributed Generation, Islanding Detection, Synchronous and Induction Machines.

## I. INTRODUCTION

The current trend in the increasing use of Distributed Generation (DG) is due to energy exhaustion and recent environmental issues. This practice enables the collection of electrical energy from a variety of sources and leads to decreased environmental impacts and improved security of supply. They are typically in the range of 1 kW to 10,000 kW and include wind farms, micro hydro turbines, photovoltaic (PV) system and other small generators which are supplied with biomass or geothermal fuel [1]. Among the many advantages of DG integration include: improved system reliability in the power supply, increased efficiency, avoidance of transmission capacity upgrades, improved power quality and reduced transmission line losses and environmental

benefits (excluding diesel reciprocating engines often used as back-up distributed generators which tend to be the worst performers in terms of greenhouse gas emissions[2]).

Despite the above mentioned merits of incorporating DGs in the distribution system, it has major drawback of unintentional islanding. Islanding condition occurs when the DG continues to power a part of the grid system even after the connection to the rest of the system has been lost, either intentionally or unintentionally. The unintentional islanding mode of operation is not desirable because of a number of reasons. For instance; it poses a threat to the line workers' safety, the islanded system may not be properly grounded resulting in high voltage in the other phases when an earth fault occurs, and most importantly, the distributed generators may not be able to maintain the voltage and frequency within desired limits in the distribution system when it is islanded.

The rest of the paper is organized as follows; section II discusses the islanding detection methods for synchronous and induction generators, then the various recent islanding detection methods for synchronous and induction generators are covered in section III, the islanding detection methods assessment tools for synchronous and induction generators are explained in section IV and finally the conclusion in section V.

## II. ISLANDING DETECTION METHODS FOR SYNCHRONOUS AND INDUCTION GENERATORS

As per IEEE standard 1547-2003, the distributed generators must sense the unplanned power grid and trip it within two seconds, failure to which may lead to several problems in terms of power quality, safety and operational problems [3]. Most of the commonly used islanding detection methods are suitable for all generators and hence the synchronous and induction machines. The general islanding detection techniques can be categorized as shown in the following diagram.

L. Mogaka, Department of Electrical and Electronics Engineering, TUM (0725597671; e-mail: [mogaka.Lucas@gmail.com](mailto:mogaka.Lucas@gmail.com)).

D.K. Murage, Department of Electrical and Electronics Engineering, JKUAT ([dkmurage25@yahoo.com.com](mailto:dkmurage25@yahoo.com.com)).

M. Saulo, Department of Electrical and Electronics Engineering, TUM (e-mail: [michaelsaulo@yahoo.com](mailto:michaelsaulo@yahoo.com)).

S. Kariuki, Department of Electrical and Electronics Engineering, TUM ([kariukisamuel2004@yahoo.com](mailto:kariukisamuel2004@yahoo.com))

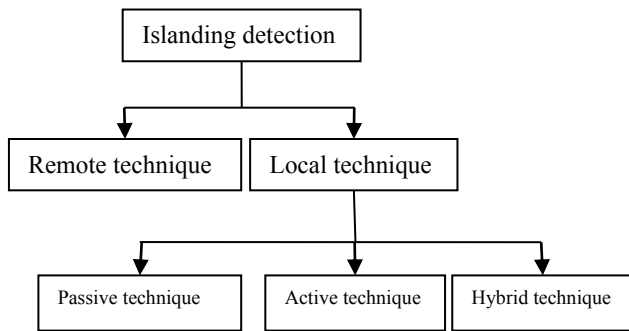

Fig 1: Islanding detection techniques [4]

A. Passive methods

Passive islanding detection techniques are preferred in island detection especially when the mismatch between the generated power and the size of the load is very large. However, when the mismatch is very small, it is difficult to detect the islanding state because the variations in voltage or frequency at the point of common coupling (PCC) are also very small [5]. The weaknesses of some of the passive islanding detection methods are highlighted in the table I below.

B. Active methods

On the other hand, as compared to passive methods, the active methods have smaller Non-Detection Zones (NDZ). However they compromise the power quality of the system by injecting small signals at certain frequencies to the system. Some of these methods, their properties and drawbacks are shown in table II below.

Table I: Passive islanding detection [6]

METHOD	IMPLEMENTATION SPEED	WEAKNESS
UFP/OPF UVP/OVP	Easy but reaction time unpredictable and variable	Large non-detected zones (NDZs)
Phase jump detection (PJD)	Difficult in implementation and hard to choose threshold	Fails to detect islanding when DG power generation matches the power demand of local load
Total harmonic distortion (THD)	Easy but hard to choose threshold	Fails to detect island in case of low distortion of voltage and current output of inverter or high quality load
Voltage Unbalance		Not applicable to single phase system

Table II: Active islanding detection methods [7]

METHOD	IMPLEMENTATION AND SPEED	WEAKNESS
Impedance measurement	Easy and fast	
Slip-mode frequency shift (SMS)	Medium and slow	Ineffective under certain load eg RLC resonant load
Active frequency Drift (AFD)	Easy and medium	
Sandia frequency shift (SFS)	Difficult and relatively fast	Problem in power quality, system stability
Sandia voltage shift(SVS)	Medium and fast	Increase harmonic distortion

Some of the most common active methods used for islanding detection for synchronous DGs include; reactive power compensation, load fluctuation, impedance measurement, reactive power fluctuation, and QC-mode frequency shift method.

C. Hybrid methods

In short, active and passive techniques have their strong and weak points. Thus these methods are at times merged to benefit from their strong points. This technique is called Hybrid islanding detection [8]. Again, there is no islanding detection scheme currently that can serve all situations in distributed system. Therefore, the method is normally selected according to the nature of the distributed generator. [9]

III. REVIEW OF RECENT ISLANDING DETECTION METHODS

Since the islanding condition should be detected as fast as possible as it is stipulated in the set international standards, researchers are continuously looking for better methods of correctly detecting this condition. To achieve this objective, signal processing tools come in handy in extracting the features from measured signals. Then artificial intelligent tools are used to classify the extracted signals to either islanded or non-islanded condition. The general steps usually followed in determining islanding state classification are shown in figure 2 below.

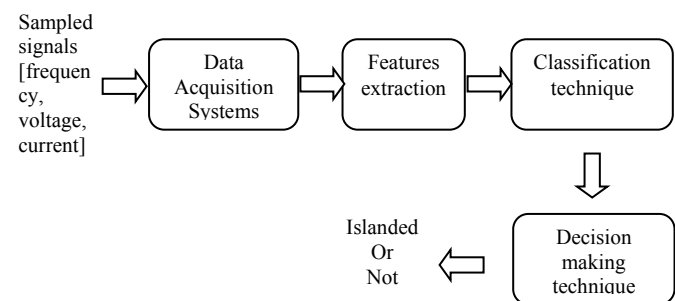

Fig 2: General islanding detection steps

### A. The Wavelet Transform

A wavelet can be defined as a small wave. A wavelet transform (WT) convert a signal into a series of wavelets that are used for analyzing waveforms that are bound in both frequency and time. Alternatively WT can be defined as a collection of functions that are used for analyzing non-stationary signals in MATLAB platform.

It is actually a new mathematical tool developed for analyzing non-stationary and fast changing wide-band signals like islanding detection in synchronous generators. The main advantage of wavelet transform is that it needs not to assume the stationery or periodicity of a signal as it is able to simultaneously distinguish both time and frequency signal information due to its multi-resolution characteristic. Hence, it becomes useful in analyzing discontinuous and time varying signals especially in islanding detection.

It has three useful properties which make it applicable in engineering applications and most importantly in islanding detection. First, it has ability to reconstruct back the signal from its wavelet transform. This is achieved due to WT ability of the resolution of identity, the ability to conserve energy in the time-scale space and the wavelet admissible condition. Secondly the WT is a local operator in both time and frequency domains. Hence, the regularity condition is usually imposed on the wavelets. Lastly, the WT has a property related to a multi-resolution signal analysis. It has the ability to analyze both high and low frequency signals. The high frequency signal analysis is done using narrow windows and the low frequency analysis is done using wide windows [10].

Wavelet analysis can be categorized into two main techniques. That is; Continuous wavelet transform and discrete wavelet transform.

### B. Continuous Wavelet Transform (CWT)

The CWT is defined as the sum over all time of the signal multiplied by scaled, shifted versions of the wavelet function. The time-scale information provided by wavelet makes it easy to extract signal features that change with time. Mathematically CWT can be expressed as follows;

$$CWT_x^\varphi(a, b) = \frac{1}{\sqrt{a}} \int_{-\infty}^{\infty} x(t) \cdot \varphi * \frac{t-b}{a} dt \quad (1)$$

Where:  $a$  is the scale,  $b$  is the translation or position,  $x(t)$  is the analyzed signal, and  $\varphi$  is the mother wavelet and is defined by:

$$\varphi_{a,b}(t) = \frac{1}{\sqrt{a}} \varphi\left(\frac{t-b}{a}\right) \quad (2)$$

The CWT is actually continuous in terms of the shift  $b$  during calculation and its operation; the wavelet that is used for analyzing the signal is shifted smoothly over the entire domain of the analyzed function. It is actually the measurement of the similarity of the wavelet to the original signal through calculating the coefficient. Thus practically continuous wavelet transform may give redundant information especially when the measured similarity coefficient is large as the

original signal and the wavelet will be similar. Hence for the sake of computation, there is need to discretize the signal.

### C. Discrete Wavelet Transform (DWT)

The voltage and current transients of a power system do have unique characteristics that signify the cause of transient occurrence. So there should be a process to extract these features to speed up response in classifying. To this end, wavelet transform seems to be suitable [11].

The discrete wavelet transform is actually the continuous wavelets with the discrete scale and translation factors. Here the wavelet transforms are evaluated at discrete scales and translations. This means that when time localization of the signal is required, the discrete wavelet transform is the one appropriate. This is especially in islanding detection. The DWT function can be defined mathematically as shown in the equation 3 below:

$$\varphi_{a,b}(t) = |a|^{-\frac{1}{2}} \varphi\left(\frac{t-b}{a}\right) \quad a, b \in R, a \neq 0 \quad (3)$$

If  $(a, b)$  take discrete value in  $R^2$ , we get DWT. A popular approach to select  $(a, b)$  is

$$\begin{aligned} a &= \frac{1}{a_0^m}, a_0 = 2, \\ a &= a_0^{-m} = \langle 1, \frac{1}{2}, \frac{1}{4}, \frac{1}{8}, \dots \rangle, \quad m: \text{integer} \\ b &= \frac{nb_0}{a_0^m}, a_0 = 2, b_0 = 1 \\ b &= \frac{n}{2^m} \quad n, m: \text{integer} \end{aligned}$$

Then

$$\begin{aligned} \varphi_{a,b}(t) &= |a|^{-\frac{1}{2}} \varphi\left(\frac{t-b}{a}\right) = 2^{\frac{m}{2}} \varphi\left(\frac{t-\frac{n}{2^m}}{2^m}\right) \\ &= 2^{\frac{m}{2}} \varphi(2^m t - n) \end{aligned} \quad (4)$$

Generally, it is a requirement that the response time of the islanding detection method should be shorter hence a lower decomposition level should be selected.

The following are some of the merits that make DWT applicable in islanding detection in synchronous and induction generators.

- a) It gives enough information for analysis purposes
- b) It sufficiently lowers the computation time
- c) Its implementation is easy
- d) Analyzes signals in different resolutions at different frequency bands
- e) Decompose the signal into a coarse approximation and detail information

As a result of the above highlighted merits. Wavelet transform has been applied in islanding detection recently as follows;

In [12], decision tree (DT) was used with a combination of discrete wavelet transform (DWT). The features from the transient voltage and current signals were extracted using the DWT, where the DT classifier was used to identify the islanding condition. In [13], the wavelet was applied to detect

the islanding condition of wind turbines. The method used DWT with db5 to determine the best wavelet basis function with accurate results. However, all these methods necessitated the measurement of several electrical quantities, which required much time in detecting islanding. In [14], a new fast method was developed for islanding detection based on measuring the utility currents and voltages signals processed by discrete wavelet transform. These features are sum of wavelet coefficients energy and were used for distinguishing the islanding conditions from non-islanding ones.

#### D. Fuzzy logic controller

A fuzzy logic controller is a control algorithm based on several linguistic control rules and it is used to analyze continuous signals. The fuzzy rule base has the ability to handle more uncertainties in the signal being analyzed that fall along the slope of the fuzzy trapezoidal membership function unlike the crisp classifiers like decision tree which have sharp boundaries, and large data base. Thus, the superior approximation capabilities of the fuzzy systems over crisp classifiers help to develop algorithms that meet the real time application with wide range of uncertainties. Hence the fuzzy logic controller can easily and accurately be used in islanding detection for synchronous and induction generators.

Some of the recent applications of fuzzy logic in islanding detection are as follows; in [15], FL was introduced from the transformation of DT, where the combination of fuzzy membership functions (MFs) and the rule base were used to develop the fuzzy rule base. This technique was easy to implement for online islanding detection and could handle uncertainties such as noise. In [16], however, the band pass filter was used to replace the function of DWT and still worked out pretty well.

### IV. ISLANDING DETECTION METHOD ASSESSMENT TOOLS FOR SYNCHRONOUS AND INDUCTION GENERATORS

#### A. Non-detection zones (NDZs)

Non-detection zones are defined as a loading condition for which an islanding detection method would fail to operate in a timely manner. It is normally evaluated by the use of active and reactive power mismatch space. The non-detected zones for synchronous generators are affected by the following factors among others:

- a. Load type
- b. generator inertia
- c. generator excitation control mode and
- d. relay settings

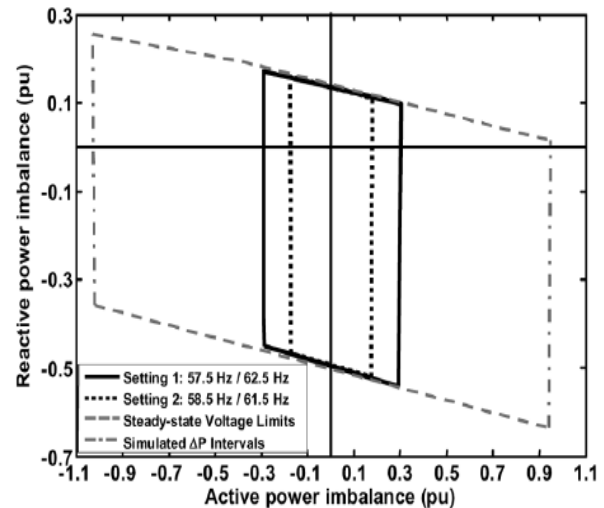

Fig 3: NDZs for different frequency relay settings [17]

#### B. Performance curves

Performance curves represent the relationship between the islanding detection times versus the active power mismatch. This graphical tool is especially useful for synchronous DGs. Power mismatches lower than the critical power imbalance make up, a NDZ, as indicated in Figure 4 below.

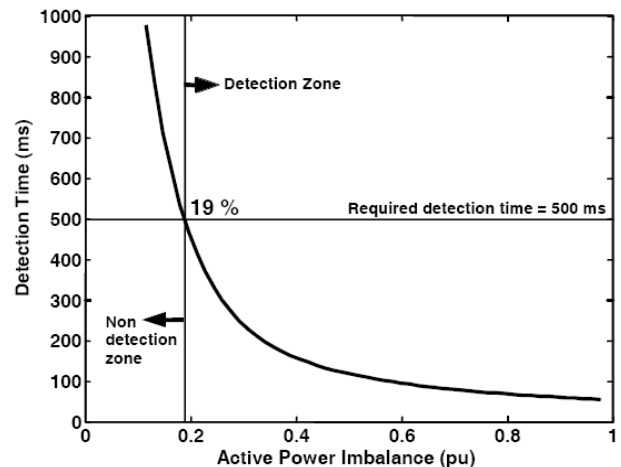

Fig 4: Performance curve of frequency-based relays [17]

In fig 4 above, at the x-axis the active power imbalance level of the islanded system of the generator is represented. Then the island detection time is represented in the y-axis. To obtain this curve the islanding occurrence simulations have to be repeated for some steps. Then, for each active power imbalance, the detection time is determined by dynamic simulation and then the performance curve is plotted [18].

### V. CONCLUSION

Unlike inverter based distributed generators, Synchronous generators with fast response governors and AVRs are highly capable of sustaining an island. Therefore, anti-islanding protection for synchronous generators is a more challenging problem in comparison with the inverter-based DG. This paper has reviewed the various methods currently used in islanding detection especially for synchronous and induction generators.

From this analysis, more has to be done especially in islanding detection for synchronous and induction generators so as to increase the power consumer confidence and reliability on the system.

#### ACKNOWLEDGEMENT

The authors would like to express the greatest gratitude to the Technical University of Mombasa for the continued support from time to time when required.

#### REFERENCES

- [1] A. Khamis and H. Shareef, "An effective islanding detection method using Neuro-Phase space technique," *World Academy of Science, Engineering and Technology*, vol. 7, June 2013.
- [2] Jeremi Martin, "Jerem Distributed vs. centralized electricity generation: are we witnessing a change of paradigm?," *paris*, 2009.
- [3] p. mahati, "Review on islanding operation of distribution system with distributed generation," pp. 1-8, 2011.
- [4] Truptimayee Pujhari, "Islanding Detection In Distributed Generation," 2009.
- [5] M. Ashour, "matlab/simulink implementation and simulation of islanding detection using passive methods," in *IEEE GC conference and exhibition*, Dola, 2013.
- [6] Aziah Khamis, "A review of islanding detection techniques for renewable distributed generation systems.," university kebangsaan, malaysia,.
- [7] Aziah Khamis, "A review of islanding detection techniques for renewable distributed generation systems.," university kebangsaan, malaysia,.
- [8] Maher. G. M. Abdolrasol & Saad Mekhilef, "'Robust hybrid anti-islanding method for inverter- based distributed generation'".
- [9] A. Etxegarai, "Islanding detection of synchronous distributed generators," in *International Conference on Renewable Energies and Power Quality (ICREPQ'12)*, santiago spain, march 2012.
- [10] Y. Sheng, *Wavelet Transform. The Transforms and Applications Handbook*, second edition ed., Alexander D., Ed. Poularikas Boca Raton: CRC Press LLC, 2000.
- [11] GHODRATOLLAH SEIFOSSADAT and MORTEZA RAZAZ. MEHRDAD HEIDARI, "An intelligent-based islanding detection method using DWT and ANN.," Chamran University. Iran , iran,.
- [12] Rajapakse A. Lidula N, "A pattern recognition approach for detecting power islands using transient signals Part I: Design and implementation.," *IEEE Transactionon Power Delivery*, pp. 3070-7, 2010
- [13] Sobhani B. Karegar H, "Wavelet transform method for islanding detection of wind turbines.," *renewable energy*, pp. 38:94-106, 2012
- [14] Hossein Haroonabadi, "Islanding Detection in Micro-Grids Using Sum of Voltage and Current Wavelet Coefficients Energy," *International Journal of Energy and Power Engineering*, vol. 3, no. 5, pp. 228-236, 2014.
- [15] El-arroudi K, Joós G, Kamwa I. Samanta ray S, "A fuzzy rule-based approach for islanding detection in distributed generation," *IEEE Transaction on Power Delivery*, pp. 1427-33, 2010.
- [16] J, Denboer, N, Lidula, N, Member, G, Perera, N, Rajapakse, A, Pham, "Hardware implementation of an islanding detection approach based on current and voltage transients.," *Electrical power and energy conference (EPEC)*, pp. 152-157, 2011
- [17] I. Zamora, P. Eguia, L. Valverde. A. Etxegarai, "Islanding detection of synchronous distributed generators," in international Conference on Renewable Energies and Power Quality (ICREPQ'12), Santiago de Compostela (Spain), march 2012
- [18] Jose C. M. Vieira, Waldir Freitas, Wilsun Xu, and Andre Morelato, *Performance of Frequency Relays for Distributed Generation Protection* *iee transactions on power delivery*, vol. 21, no. 3, july 2006.

# Effect of Capacitance on Electrical Discharge Machining Using an RC type Pulse Generation Circuit

Kabini S. K.<sup>1\*</sup>, Bojer S. K.<sup>2</sup>, Ikua B. W.<sup>3</sup>, Kihui J. M.<sup>3</sup>, Nyakoe G. N.<sup>3</sup> and Mwangi J. W.<sup>3</sup>

**Abstract**—The Electrical Discharge Machining (EDM) Process is complex in nature partly due to the mechanism of material removal, and, partly due to the presence of many machining parameters. This complexity of the EDM process has undermined its full potential drastically reducing its efficiency. In turn, this has led to relatively higher consumption of electrical energy, longer machining periods, higher rate of electrode wear and lower surface quality of the finished product. Various researchers have used varied approaches with the aim of optimizing the process.

However, most of these researches have focused on optimization of one or at most two parameters and have used either fuzzy logic control techniques or modeling approaches. Others have used purely predictive and non-realtime approaches. All of these do not offer the advantage of realtime control of the process.

This paper focuses on experimental work carried out to establish the effect of capacitance on the EDM process. This is part of an ongoing research who's aim is to study the EDM process with a view to designing a controller that is capable of improving the process' efficiency by optimizing all the machining parameters in realtime.

**Keywords**—Capacitance, EDM, machining, MRR.

## I. INTRODUCTION

**E**LECTRICAL discharge machining (EDM) is a thermal machining process, capable of accurately machining parts from conductive materials irrespective of the material's hardness or parts that have complex shapes. EDM is a very desirable manufacturing process when machining fewer products or high accuracy is needed and is, especially well-suited for cutting intricate contours or delicate cavities such as molds that would be difficult to produce using mechanical means such as grinding or milling [1]. The EDM process is used to produce tools that aid in mass production. However, the efficiency of the EDM process is low and as such, it is only used when the cost and time of machining are not a major consideration. An example of such a case is where the material being machined is too hard to be machined by other machining processes. This is because there is excessive tool wear and the material removal rate in EDM is very low as compared to other machining processes.

EDM is arguably one of the most accurate manufacturing processes available for machining complex or simple shapes and geometries [2]. The EDM process is illustrated in Figure

1.

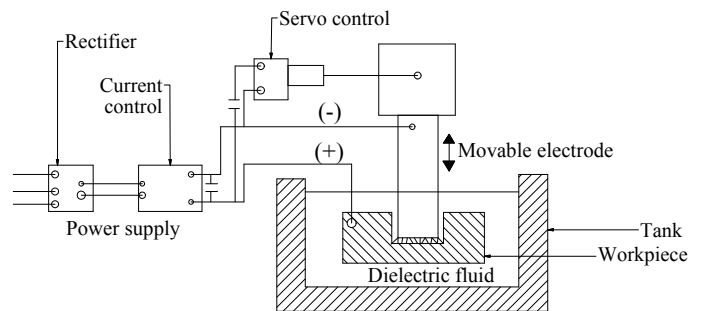

Fig. 1. Illustration of the EDM process

## II. PREVIOUS WORKS ON EXPERIMENTAL INVESTIGATION AND MODELING OF EDM

Shabgard *et al* [3] investigated the influence of electrical discharge machining input parameters on the output characteristics of the process. The process characteristics including machining features, i.e., material removal rate, tool wear ratio, arithmetical mean roughness, and surface integrity characteristics comprising of the thickness of white layer and the depth of heat affected zone in machining of AISI H13 tool steel were investigated. The results showed that, when machining AISI H13 tool steel,

- Increase in pulse on-time led to increase in material removal rate, surface roughness, as well the white layer thickness and depth of heat affected zone
- Maintaining constant level of discharge energy, high pulse current and low pulse on-time led to reduction in the white layer thickness and depth of heat affected zone on the surface of the machined workpiece

A study on optimal cutting parameters in wire EDM where a feed-forward neural network was used to associate the cutting parameters with the cutting performance was conducted by Targ *et al* [4]. A simulated annealing (SA) algorithm was applied to neural networks for solving the optimal cutting parameters based on a performance index. Experimental results showed that the performance of wire-EDM would be greatly enhanced using this approach.

Scott *et al* [5] investigated the effects of spark on-time duration and spark on-time ratio, on material removal rate (MRR) and surface integrity of four types of materials During

<sup>1\*</sup> Corresponding author: School of Mechanical, Manufacturing and Materials Engineering, JKUAT, P.O. Box 62000-00200, Nairobi (phone: +254720980179; e-mail: skkabini@gmail.com).

<sup>2</sup> Friedrich Alexander Universität Nürnberg Erlangen, Technical Faculty.

<sup>3</sup> School of Mechanical, Manufacturing and Materials Engineering, JKUAT, P.O. Box 62000-00200, Nairobi.

current and voltage depended on the electrode material when the other machining conditions were kept constant. However, the other machining parameters do change during machining process and cannot be assumed constant.

A study on optimal cutting parameters in wire EDM where a feed-forward neural network was used to associate the cutting parameters with the cutting performance was conducted by Tarng *et al* [5]. A simulated annealing (SA) algorithm was applied to neural networks for solving the optimal cutting parameters based on a performance index. Experimental results showed that the performance of wire-EDM would be greatly enhanced using this approach.

Scott *et al* [6] investigated the effects of spark on-time duration and spark on-time ratio, on material removal rate (MRR) and surface integrity of four types of materials. During the wire EDM process, five types of constraints on the MRR were used. These were due to short circuit, wire breakage, machine slide speed limit, and spark on-time upper and lower limits. An envelope of feasible EDM process parameters was generated for each work-material. This process envelope was used to select process parameters for maximum MRR and for machining of micro features. Results of Scanning Electron Microscopy (SEM) analysis of surface integrity showed that the envelope was an effective tool in the selection of the EDM machining parameters for maximum MRR and good surface finish in micro-machining.

Yongshun *et al* [7] developed a geometric model of the linear motor driven EDM process based on Z-map method. The model was employed to calculate the minimum gap distance required for sparking to occur and also analyze the possibility of spark generation between the workpiece and electrode surfaces. The final machined surface topography was then predicted by the model. The influence of peak current and discharge duration on the average surface roughness was also simulated. Experimental work verified the effectiveness of the developed geometric model.

Pecas and Henriques studied the influence of silicon powder mixed dielectric in EDM [8]. Using the silicon powder mixed dielectric, the performance of EDM was investigated. The improvement was assessed through quality surface indicators and process time measurements, over a set of different processing areas. The results showed positive influence of the silicon powder in the reduction of the operating time, required to achieve a specific surface quality, and in the decrease of the surface roughness, allowing the generation of mirror-like surfaces.

Bulent *et al* [9] used a semi-empirical approach to model residual stresses in electric discharge machining (EDM). Layer removal method was used to measure the residual stress profile as a function of depth beneath the surface caused by die sinking type EDM. Cracking and residual stresses were studied on samples machined at long pulse durations. A modified empirical equation was developed for scaling residual stresses in machined surfaces with respect to operating conditions.

Debris accumulation in the discharge gap cause a poor machining stability and low production efficiency. Jin *et al* [10] investigated debris and bubble movements during EDM

process. Experimental devices using transparent materials were used to observe debris and bubble movements. Based on the observations, the mechanism of debris and bubble exclusion during consecutive pulse discharges was analyzed, and the effects of the electrode jump height and speed on the debris and bubble movements investigated. It was found that during an electrode down time, the bubble expansion was the main factor that excluded the debris from the spark gap. At the beginning of consecutive pulse discharges, the bubbles excluded the debris from the gap. As the discharge continued, the bubbles ability to exclude the debris became weak, resulting in a debris aggregation in the gap and, thus, an unstable machining. Finally, it was observed that the electrode jump speed affected the mixing degree of the debris and oil.

Nizar *et al* [11] numerically studied thermal aspects of EDM process. The numerical results concerning the temperature distribution due to the process were presented. From these thermal results, the MRR and the total roughness were deduced and compared with experimental observations. The comparison showed that, taking into account the temperature variation of conductivity was of crucial importance and gave the better correlations with experimental data.

Seiji *et al* [12] used a combination of capacitance and conductive working fluid to speed up the fabrication of a narrow, deep hole in metals using EDM process. This was done by use of a dielectric-encased wire electrode, as opposed to the conventional pipe electrode. The dielectric jacket was used to completely suppress unnecessary secondary discharges occurring between the sidewalls of the wire and the fabricated hole. The effectiveness of the combination of conductive working fluid and a capacitor connected to the work piece and the tool electrode was examined. Although electrode wear was severe, machining speed in this case was twice as fast compared with fabricating a hole (without a capacitor and saline water in a 20 mm thick carbon steel block).

Muniu *et al* [13] investigated the applicability of diatomite powder-mixed dielectric fluid in EDM process. In the research, the effect of diatomite powder suspended in distilled water was investigated using graphite as the tool electrode on mild steel workpiece. The process parameters that were used were peak current, pulse-on time and powder concentration. Results showed that, the suspension of diatomite powder in dielectric fluid improved the performance characteristics of conventional EDM process.

### III. THEORY OF OPERATION

The EDM machine that was used has a capacitive type of pulse generator. The charge across a capacitor is given by

$$Q = CV \quad (1)$$

given that the current through a capacitor is given by

$$i = C \frac{dV}{dt} \quad (2)$$

Differentiating equation 1, then

$$\frac{dQ}{dt} = C \frac{dV}{dt} \quad (3)$$

Thus, equating equations 2 and 3 gives

$$i = \frac{dQ}{dt} = C \frac{dV}{dt} \quad (4)$$

Integrating both sides,

$$\frac{1}{C} \int idt = V \quad (5)$$

In Laplace transform,

$$sI = CV(s) \quad (6)$$

#### IV. EXPERIMENTAL SETUP

The experiments were conducted using an EDM machine fabricated in JKUAT. Various identical workpieces of the same material (mild steel) were machined using different machining parameters as indicated in the Table 3 below. The workpieces were uniform and from the same material. The samples were each machined for 30 minutes in order.

Sample	Applied Capacitance ( $\mu\text{F}$ )	Machining time (s)
1	55	180
2	110	180
3	165	180
4	220	180
5	275	180
6	330	180
7	440	180
8	510	180
9	620	180
10	640	180
11	730	180

Fig. 2. Machining parameters

#### V. RESULTS AND DISCUSSION

Table 3 shows the applied and measured parameters in EDM machining while using a capacitance type pulse generator. The resultant gap voltage and current are indicated for each machined sample. It is also worth noting here that, the frequency of the pulse signals generated was not constant and it reduced with increase in capacitance. This is so because;

$$f = \frac{1}{2\pi RC} \quad (7)$$

However, since the resistance of the machine is not known, the pulse frequency was not calculated.

From Figure 4 above, it can be noted that, increase in the spark gap voltage led to reduction in root mean square (rms) surface roughness. It can be observed from the Figure that, at a gap voltage of about 45V, the root mean square surface roughness was the highest. It can also be noted that, as the gap voltage approaches 40V, the rms surface roughness is reduced.

The rms surface roughness of the machined workpiece was observed to increase with the increase in spark gap current as

Sample	Gap Current (A)	Applied Capacitance ( $\mu\text{F}$ )	Gap Voltage (V)	RMS Surface Roughness ( $\mu\text{m}$ )	Depth of Cut (mm)
1	1.0	55	60	12.6	1.73
2	1.0	110	60	13.4	1.77
3	1.0	165	60	13.5	1.80
4	1.0	220	60	13.7	1.83
5	1.5	275	50	13.8	1.80
6	1.5	330	50	14.2	1.87
7	2.0	440	40	14.2	1.93
8	1.7	510	50	14.4	2.03
9	1.8	620	45	14.5	2.05
10	2.2	640	45	14.7	2.05
11	1.8	730	45	15.1	2.11

Fig. 3. Machining parameters

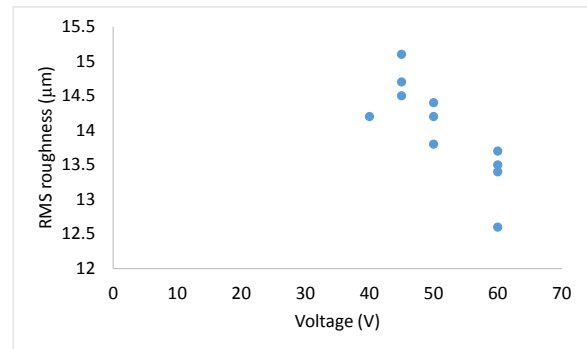

Fig. 4. Effect of voltage on surface quality

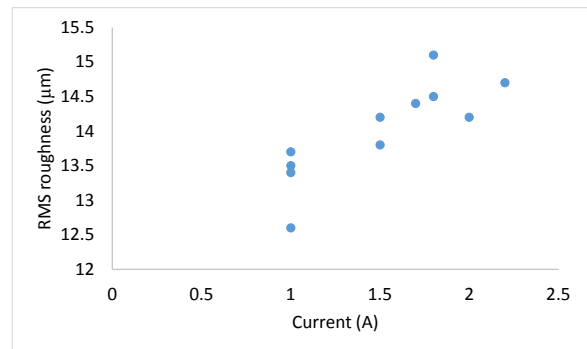

Fig. 5. Effect of current on surface quality

shown in Figure 5. However, it was noted that the material removal rate increased with increase gap current. It was also noted that the increase in surface roughness reached a maximum at a gap current of about 1.8A. This also shows the period at which the material removal rate was maximum after which it falls down gradually with further increase in current. From Figure 6, it can be observed that, the surface roughness increases with increase in the applied capacitance. During the experiments, it was also observed that, the sparking process was more spontaneous when the capacitance was high. This in turn lead to faster machining time because the material removal rate increased.

From Figure 7 and since all the samples were machined for the same period of 30 minutes, comparison of the depths of cut of each machined sample indicates the material removal rate. The material removal rate is seen to have been highest



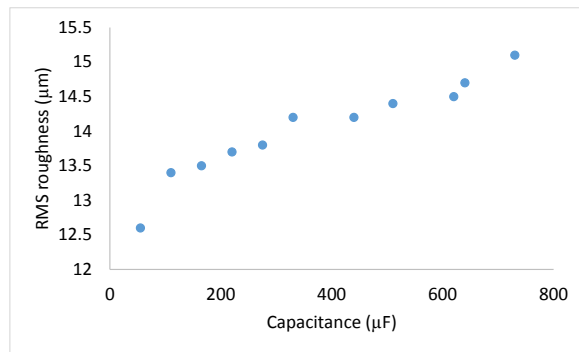

Fig. 6. Effect of capacitance on surface quality

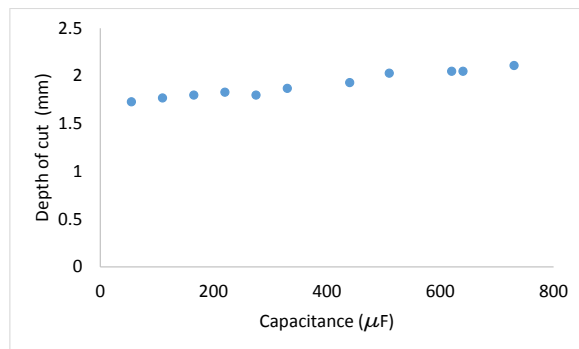

Fig. 7. Indication of MRR with increase in capacitance

when the values of the capacitance and the spark gap current were high. During this time however, the value of spark gap voltage was low.

## VI. CONCLUSIONS

The effect of increasing capacitance in EDM machining has been found to be poor quality surface finish and improved material removal rate. However, in most cases in machining, there is always a compromise between the material removal and the surface quality. Further research will be carried out to determine the optimum values of current and voltage for machining without compromising on any of the two. Notable also is the limitation of the pulse type generator in that, when capacitance is adjusted, the gap current and voltage are not adjustable. Future works will involve the use of a transistorized pulse generator for the EDM machine.

## ACKNOWLEDGEMENT

The authors would like to thank Jomo Kenyatta university of Agriculture and Technology for funding this research. Special thanks also go to one of the authors, Sile, for her commitment in carrying out the experimental work.

## REFERENCES

- [1] Zhang Q.H., Du R., Zhang J.H., Zhang Q.B., "An investigation of ultrasonic-assisted electrical discharge machining in gas," *International Journal of Machine Tools and Manufacture*, vol. 46, pp. 1582–1588, 2006.
- [2] Huang J.T. and Liao Y.S., "Optimization of machining parameters of wire-EDM based on grey relational and statistical analysis," *International Journal of Production*, vol. 41, no. 8, pp. 1707–1720, 2003.
- [3] Shabgard M. R., Seyedzavvar M. and Nadimi Bavil Oliaei S., "Influence of input parameters on characteristics of EDM process," *Journal of Mechanical Engineering*, vol. 2, pp. 123–135, 2006.
- [4] Carlo Ferri, Atanas Ivanov and Antoine Petrelli, "Electrical measurements in micro-EDM," *Journal of Micromechanics and Microengineering*, vol. 18, pp. 1–13, 2008.
- [5] Tarn Y. S. Ma S. C. and Chung L. K., "Determination of optimal cutting parameters in wire electrical discharge machining," *International Journal of Machine Tools and Manufacture*, vol. 35, no 12, pp. 1693–1701, 1995.
- [6] Scott F. Miller, Albert J. Shih and Jun Qu, "Investigation of the spark cycle on material removal rate in wire electrical discharge machining of advanced materials," *International Journal of Machine Tools and Manufacture*, vol. 44, pp. 391–400, 2004.
- [7] Yongshun Zhao, Xingquan Zhang, Xianbing Liu, Kazuo Yamazaki, "Geometric modeling of the linear motor driven electrical discharge machining (EDM) die-sinking process," *International Journal of Machine Tools and Manufacture*, vol. 44, pp. 1–9, 2004.
- [8] Pecos P. and E. Henriques, "Influence of silicon powder-mixed dielectric on conventional electrical discharge machining," *International Journal of Machine Tools and Manufacture*, vol. 43, pp. 1465–1471, 2003.
- [9] Bulent Ekmekci, A. Erman Tekkaya and Abdulkadir Erden, "A semi-empirical approach for residual stresses in electric discharge machining (EDM)," *International Journal of Machine Tools and Manufacture*, vol. 46, pp. 858–868, 2006.
- [10] Jin Wang, FuzhuHan, Gang Cheng, Fuling Zhao, "Debris and bubble movements during electrical discharge machining," *International Journal of Machine Tools and Manufacture*, vol. 58, pp. 11–18, 2012.
- [11] Nizar Ben Salah, Farhat Ghanem, Kais Ben Atig, "Numerical study of thermal aspects of electric discharge machining process," *International Journal of Machine Tools and Manufacture*, vol. 46, pp. 908–911, 2006.
- [12] Seiji Kumagai, Naoki Sato and Koichi Takeda, "Combination of capacitance and conductive working fluid to speed up the fabrication of a narrow, deep hole in electrical discharge machining using a dielectric-encased wire electrode," *International Journal of Machine Tools and Manufacture*, vol. 46, pp. 1536–1546, 2006.
- [13] Muniu J. M., Ikua B. W., Nyaanga D. M. and Gicharu S. N., "investigation on applicability of diatomite powder-mixed dielectric fluid in electrical discharge machining processes," in *Sustainable research and innovation conference proceedings*, vol. 4, pp. 280–288, 2012.

# Developing a Sewerage Management System for Kisii Town Using GIS and Remote Sensing

HENRY ABUGA and CHARLES MUNDIA NDEGWA

**Abstract**—Rapid population growth, coupled with failing and outdated sewer infrastructure, is overstressing sewer systems in Kenya leading to sewerage pollution. The usual manual based, localized, “find and fix as you go” approach is neither reliable nor cost effective and cannot be relied on to improve system design and its overall performance. This study was undertaken to develop a sewerage management system for Kisii town in Kisii County using Geospatial technologies and propose a new sewer line. To achieve these objectives, primary and secondary datasets including Kisii Town development plans, High resolution satellite images, topographical maps, population data, questionnaires based interviews and GPS mapping were used in GIS environment to analyze and model the sewer system. The Analytical Hierarchical Process (AHP) which relies on the judgment of experts in assigning weights was used in optimizing the location of the proposed new sewer line.

Results show that seventy percent of the available data is not accessible, that accessing the data is very slow and expensive and substantial numbers of files are either missing or misplaced. Questionnaire analysis results indicate that majority of those interviewed would prefer the computerization of the sewage information system for Kisii Town. Model results show that the optimal areas lie near Daraja mbili area as the base for the proposed sewer line. The research findings indicate that the County government of Kisii could benefit through the use of geospatial technologies to facilitate the management of data and implementation of sewer models

**Keywords**—Geospatial technologies, Kisii, modeling sewer line, sewerage management system

## I. INTRODUCTION

According to Kenya’s development blueprint, the Vision 2030, the country aims to have clean, secure and sustainable environment by ensuring improved waste management through the design and application of economic incentives for improved efficiency in water and sanitation delivery. This will also ensure reduced environmental related diseases by ensuring improved water and sanitation in both urban and rural areas. It is estimated that by the year 2030, most of Kenya’s population will be urban and therefore there is need to provide for secure plans for decent and high quality urban livelihood (Kenya Vision 2030).

Kenya’s vision 2030 pillar on infrastructure envisages a country that will be firmly interconnected through a network of water and sanitation systems. Access to safe drinking water, basic sanitation and proper hygiene can prevent waterborne diseases by nearly 90% and lead to improved health, poverty reduction and socio-economic development. The Millennium Development goals (MDG) set by the United Nations requires developing countries to reduce by halve the

proportion of people without sustainable access to safe drinking water and basic sanitation by the year 2015. Anthropogenic activities have unbearably contaminated and polluted surface water resources. Groundwater is also becoming polluted with increasing frequency, and the resulting dangers to man are alarming because polluted water is a very sure pathway of numerous infectious disease causing organisms, (Tamunobereton-ari .et al., 2013).

The task of designing a new sewer line is an important task thus proper planning is essential in-order to maximize the benefits derivable from the use of the sewer line (Balogun et al. 2012). With the careful planning of a route, cost, time, and operating expenses can be saved, ensuring longer operational life and minimizing environmental pollution.

The major objective of this research is creating a sewer database, GIS analysis and spatial modeling in order to come up with an optimal sewer line system for Kisii County. GIS tools which bring new approaches to sewer line routing enabling all factors affecting the route be considered and weighted under one umbrella. GIS includes scientific and technological tools that enable the integration of data from different sources into a centralized database from which the data is modeled and analyzed based on its spatial component.

The inefficient and traditional methods of optimal sewer line location are mainly based on expensive and protracted methods. These methods utilize static paper maps which are huge and bulky, furthermore, they are not precise and the role of all effective parameters in sewer line location cannot be easily considered. Technical, economic and environmental concerns are not observed in designed paths as a result of these outdated methods. This calls for a method that overhauls all the demerits. GIS methods are efficient tools for decision making which are effective and efficient. GIS-based tools and processes have been extensively used to address the challenges of optimizing sewer line networks based on the collection, processing and analysis of spatial data.

GIS-based tools and processes have been extensively used to address the challenges of optimizing sewer lines, selection and route networks based on the collection, processing and analysis of spatial data such as topography, vegetation, soil type, land use, geology and landslide areas. It represents an approach to sewer line location that is systematic and effective. Optimizing a sewer line is essentially an optimization between costs of the material and the costs of the construction, spatial variations in construction cost due to changing features like types of soils, intervals of slope.

GIS allows the engineer to use dynamic spatial models to aid in selecting an optimized sewer line location. The GIS software and data enables the processing of a large amount of location-based information to find optimal locations by taking into account natural and manmade obstructions.

The problems facing the area have been compounded by gaps in research and limited emphasis on the assessment of change through spatial information technologies such as GIS, Using remotely sensed satellite imagery and GIS modeling, an Urban spatial data infrastructures and spatial analysis are growing hence GIS approach is very efficient as a tool to facilitate the decision-making process. To allow urban management modernization and future distribution of

Henry Abuga . Institute of Geomatics, GIS and Remote Sensing (IGGRS),DEKUT ( phone: +2540722924348; P.o.box 657-10100-nyeri, Kenya.; abugahenry05@gmail.com).

Charles Mundia Ndegwa Author, IGGRS,DEKUT ( phone: +2540729933154 (e-mail: ndegwa.mundia@gmail.com)).

activities in space, there are needs to have a tool or support system, which will handle the larger volume of spatial and non-spatial. This system will be capable of carrying out complex and sophisticated analysis, processes and eventually produce sustainable and efficient plans (Muthusamy, 2003)

#### Problem statement

Kisii County development profile 2013, indicate that the county headquarters has had a rapid increase in population. It is home to major businesses, institutions of higher learning and commercial banks. Kisii town however, does not have appropriate drainage systems. The existing one is old and dilapidated Waste is not properly managed since most households are not connected to the existing sewer lines. Waste disposal in many places is by landfills through Pit latrines which is unhygienic and a health hazard. This has resulted in poor sanitation and environmental pollution which have led to outbreak of water borne diseases.

With its new status as a county headquarters, Kisii town urgently needs better services to serve the expected increase in population.

#### Objectives of the study

The major objective of the study is to develop sewerage Management System for the Kisii town that will allow proposing a new sewer line for Kisii Town. This will involve Geo database creation, spatial modeling and GIS analysis for optimal sewer line location. This will also involve deriving a weighting criterion for sewer line planning using Analytical Hierarchy Process and modeling using these weightages, in the process of sewer line location.

To carry out a detailed analysis of the existing sewer system;

To create a GIS database for sewerage management and information system for Kisii town and to propose a new sewer line to serve Kisii Town.

#### Research questions

What is the current status of sewer services in Kisii Town?

What's the best method that can be used to weight the different variables that affect the sewer line? And What would be the optimal sewer line location for Kisii Town?

Absence of a functional sewer line location will lead to poor sanitation and environmental pollution which will be detrimental to the Kenyan economy. The traditional methods of sewer line location are inefficient and do not consider all the possible variables. Due to the hilly topography, the frequent rains and ineffective drainage system, management of water sewerage services have remained a challenge.

Kenya government has put in a lot effort ensure the country improves sanitation standards and eradicates water borne diseases while at the same time ensuring that devolved governments are functional. The government also desires to meet the Millennium development goals, As per the Final project report of September 2008, Gusii Water and Sanitation Company (GWASCO) was Selected in the Lake Victoria to achieve Millennium Development Goal(MDG) targets for water and sanitation in small urban centers, taking into account the physical planning needs of these urban centers together with attention to drainage and solid waste management as an integral part of environmental sanitation, as well as requirements of other multilateral agreement. This research work is therefore in line with the government's agenda in the health sector.

Implementing a sewer system using GIS has advantages in terms of speed of data processing and analytical capability. Manual sewer location processes are very tedious in nature (Henley & Henning Dresp, 2012). Currently sewerage information in Kisii is held mostly in paper form and managed manually. Once implemented, GIS can

be used to analyze different location scenarios and allow quick decision making for resource management.

Achieving vision 2030 targets will be difficult if not impossible without clean living environment and proper sanitation. The construction of the sewer line in Kisii will contribute to attainment of vision 2030 by ensuring proper management of sewerage. After the promulgation of the new constitution of Kenya, 2010 (COK 2010), water and sanitation were among the services that were devolved from the national Government to the counties. The New constitution emphasizes access to clean and safe water in adequate quantities and reasonable standards of sanitation. This project is therefore in support of the implementation of devolved governments as required under the new constitution. The most significant deficiencies in the sewer line projects carried out in Kenya and elsewhere include among others lack of clear decision-making criteria and methods alongside inadequate stakeholder involvement (Taylor et al. 2007). This will be addressed in the method devised for weighting and involvement of some of the stake holders such that there will be improvement in decision consensus.

Due to unavailability of data, this study is limited to the municipality of Kisii and not the entire Kisii County as originally envisaged.

#### BACKGROUND

The GIS approach to sewer management and sewer line routing optimization is based on relative rankings and weights assigned to project specific factors that may affect the potential location. The result of this process is an optimal path which maps out that most economic location (Henley & Dresp, 2012). Planning for the sewer optimum route will require an extensive evaluation process to identify the best possible path. The factors are chosen to balance engineering and construction costs against environmental costs and its sustainability.

Manual sewer line planning uses available maps, surveys and experience but may be heavily constrained due to lack of updated data and quantitative approach. This is accentuated for complex terrains and lengthy routes. GIS method on the contrary uses updated maps from latest Remote Sensing data, integrates thematic cost layers in GIS environment and computes all possible routes with associated costs making it the most reliable (Dubey, 2000).

During the last decade, a few attempts have been made to automate sewer route planning process using GIS technology and the methodology is still at an exploratory stage. Moreover, due to the complexity of the routing problem, the proposed methods have not been tested in very high altitude rugged terrains (Saha et al. 2005). In a study done by (Saha et al. 2005) concludes that computer assisted methodology of route planning is very fast in comparison with the conventional manual practice. It takes 13 minutes for a test area of 1.5km by 1.5 km using the computer-based, least- cost, and route-finding process in contrast; the same process may take many days by the manual approach, even if all the datasets are readily available. He proposes an algorithm which its efficiency can further be increased as the processing technology advances.

He further observes that with GIS-based methodology, it is possible to integrate and analyze various parameters related to sewer route development and maintenance at the same time. In the manual method, it is difficult to consider a large number of parameters at the same time to conduct a purposeful analysis. In manual sewer route-alignment practice, it is quite possible that an alternate best route becomes unknowingly overlooked. In contrast, the methodology he proposes an algorithm to find the least-cost path. The algorithm is intelligent, fast and efficient, and considers all possible combinations of routes between the source and the destination points. Therefore, the least cost path identified by the algorithm would provide the best option with certainty.

The weighting-rating values he used were based on a comparative study of various thematic data layers and discussions with different experts working in different areas of specializations. The weighting values used is the raw comparisons from the expert; a sewer line that avoids landslide prone areas saves on time as opposed to the manual process was the result of the study. A study done in the Caspian Sea region utilizes remote sensing and GIS tools to come up with costs associated with terrain conditions, land use among others. The costs were computed based on the experience of various earlier sewer projects. The Spatial Analyst module was used to extract the least-cost route from a cumulative cost surface. It was shown that the least-cost path derived in this study was 21% (52km against 42km) longer than the straight-line path between the source and destination, but it led to a reduction in construction costs of 14% in the area considered (Feldman et al. 1995).

The model developed incorporated pipeline length, topography, geology, land use, and stream, wetland, road, and railroad crossings. Satellite remote sensing imagery was used as a base to display results and the land cover. The length and cost associated with a straight line path between four predetermined points along a section of the sewer line were compared with the length and cost of the least cost pathway. The least cost pathway avoided urban and industrial cells on the straight line route. The weighting criteria used is not documented.

A similar research was carried out to come up with an optimal route location in Malaysia using GIS and specifically the spatial analyst module of Arc/Info in ArcGIS. The integration of GIS and Multi-criteria decision Analysis (MCDA) in optimal route selection was analyzed. To further validate the findings, he involved the community in weight derivation although no comparison was done using an existing route in order to validate the results. The two methods provide insights on how they can complement each other in ensuring a very high level of accuracy in the generated route (Balogun et al. 2012).

In an AHP based study to investigate MCDA weighting GIS methodology and Analytical Hierarchy Process were combined to derive weightages for routing. The mode of gathering expert opinion for the AHP model could not be implemented in its conventional form, because it could not incorporate the sub classes of particular criteria. An attempt to do so would have been inconsistent and tedious in making the pair wise comparison. The AHP model was modified and the results showed that it scores over the conventional method of gathering pair wise comparisons (Suresh & Nonis, 2007). Epidemics or disease outbreak can result when sanitation is not given considerable attention, (Burian et al, 2000). Several researches have also documented the consequences of poor sewerage management. Lack of proper sewage systems can result in the contamination of surface water and groundwater, and the subsequent spread of infectious diseases associated with sewage such as cholera, and typhoid fever, (Tamunobereton-ari et al, 2013)

At the very first level, locations are reflected as a unified georeferencing framework which can be used to integrate geospatial data and maps. General public without professional knowledge can easily compare and investigate various planning scenarios. Since urban planning is normally based on the status quo evaluation of the complex urban system and simulation of possible solutions, it may not be practical to consider all factors in one model, (Tao, 2013).

There are two main steps in implementing a solid waste management program. These steps include the identification of potential sites through preliminary screening, and the evaluation of their suitability based on environmental impact assessment, engineering design and cost comparison preliminary screening which should be pragmatic so that areas of social and environmental significance are excluded without removing large numbers of technically advantageous sites from consideration. This issue of optimum criteria and appropriate

methodologies is vital in most developing countries because planning regulations are not as well established like areas with steep slopes, in a decision-making process, the human cognitive evaluative structure is rather inexact. Analytic hierarchy process (AHP) is used to derive weights for criteria's maps ( Charnpratheep et al., 1997). Use of multicriteria evaluation by incorporating the AHP method (Saaty 1980) is based on a composite suitability analysis using map overlays, (O'Leary et al. 1986).

There is need to implement policies and measures in such a way as to minimize adverse effects on environmental impacts ;Solid waste disposal on land and Wastewater handling,(Kyoto protocol,1998),hence there is need to locate meters to maximize the likelihood of detecting system blockages and sanitary sewer overflows (SSO) disruptions. The problem is solved using a set-covering approach and allows the trade-off between the number of detections and the cost of gauges to be easily assessed, (Sier and Lansey, 2005).

A study by Gruen (2013) reveals that "smartness" can be expressed by its 6-axes model: smart economy, mobility, environment, people, living and governance. Only if all these elements are in balance a city can fulfil its request for sustainability and quality of life. A smart city possesses spatial intelligence. This summarizes all components in terms of brain, hard and software, which are required to manage a city efficiently with the goal to sustain high quality of life over a long period of time (resilience). As such, it refers to informational and cognitive processes, such as information collection and processing, real-time alert, forecasting, learning, collective intelligence and distributed problem solving. In this environment, the Geo- Spatial Information Sciences play a key role, providing for the underlying theoretical framework and practical procedures for data acquisition, processing, analysis and representation.

Gerhager and Sahoo (2009) asserts that the technical interventions in Yemen In the early 1990s were implemented through future investment planning and the set-up of a geographic information system, while training programmes for technical tasks supporting the improvement of the investment and services.

The waste management hierarchy can be ranked according to the preferences given to prevention from waste followed by waste reduction, re-use, recycling and energy recovery. Principles of the use and disposal of waste, waste management plans, approval procedures, and monitoring, are also to be explored , (Przewrocki et al., 2004).

Analytic Hierarchy Process (AHP) is a multi-criteria decision-making approach and was introduced by Saaty. The AHP has attracted the interest of many researchers mainly due to the nice mathematical properties of the method and the fact that the required input data are rather easy to obtain. In many industrial engineering applications the final decision is based on the evaluation of a number of alternatives in terms of a number of criteria. This problem may become very difficult one when the criteria are expressed in different units or the pertinent data are difficult to be quantified. The Analytic Hierarchy Process (AHP) is therefore an effective approach in dealing with this kind of decision problems.

AHP is an analytical tool that enables explicit ranking of tangible and intangible criteria against each other for the purpose of selecting priorities, (Saaty, 1994). The process involves structuring a problem from a primary objective to secondary levels of criteria and alternatives. Once the hierarchy has been established, a pair wise comparison matrix of each element within each level is constructed. AHP allows group decision-making, where group members can use their expertise, experience, and knowledge to break down a problem into a hierarchy and solve it by the AHP steps. Comparisons are made based on standards established by experience( saaty,1990).The smaller of each pair is used as the unit and the larger one is measured in terms of multiples of the unit.

Very often qualitative data cannot be known in terms of absolute values. Pair wise comparison has been used to determine the importance of a given computer software in terms of user adaptability criteria this calls for relative qualification or weighting.

A study by Charnpratheep et al., (1997) applied GIS and the analytic hierarchy process (AHP) for preliminary land fill site screening the identification of potential sites through preliminary screening, and the evaluation of their suitability based on environmental impact assessment, engineering design and cost comparison, unsuitable areas were excluded and retained potential areas for the site evaluation process. The criteria used for preliminary screening include primarily the proximity of potential sites to geographic objects that may be affected by the landfill like groundwater wells or that may affect landfill operations like areas with steep slopes. Methodologies used were based on a composite suitability analysis using map overlays. Based on selected criteria, by creating buffer zones around geographic features to be protected. All map layers were then intersected so that the resulting composite map contains two distinct areas. For example, when saying the preliminary landfill site should be far away from a built-up area, the question of how far is far arises. One may arbitrarily set the boundary between far and not far. Criteria used for the preliminary site screening are distance from key geographic features and topography. These are organized into four main groups: human settlement, natural resources, roads and topography. The human settlement group includes the distance from groundwater wells, schools, villages, temples, urban built-up areas and archaeological sites.

GIS and MCDA techniques have been widely applied for Railway Route Selection for the Proposed Kenya-Sudan Railway, (Kiema et al.2014). Based on GIS and Multi-Criteria analysis, railway design needs are assessed and suitable factors and constraints for analysis are derived. Various map layers were prepared and reclassified to meet the various needs.

Layers are combined with the destination to automatically generate four alternative routes each constrained to pass through a priori selected locations along the corridor from which the most optimal one was selected.

In the study, GIS-based simulation of urban sewerage flow volume by Yoo, 2005. Sewerage flow Volume simulations for all pipelines allowed the calculation of preferable pipe sizes for calculated volumes under assumed conditions and thus the identification of pipes most prone to cause flooding if sewerage flow volumes increase due to redevelopment population increase. The potential to produce information that can be used in decision making support for redevelopment in any city with a similar wastewater drainage system can be assumed. Traditional information methods do not support simulation/ modeling. The data used to manage the rapidly expanding infrastructure like during redevelopment are so voluminous and spatially oriented that Geographic Information Systems. Topologic chain numbers as a pipe order were generated for network segments (connected at nodes) so that flow volume increases 'downstream' along the network could be computed in reference to the attribute data about pipe sizes.

A study by Ouma. et al, 2011 employed GIS and Multi-Criteria Analysis in landfill site selection for growing urban regions; many factors were taken care of in the locating process like transportation, water resources. Weightings were assigned to each criterion depending upon their relative importance relative magnitude of impact. The results, analyzed using neighborhood-proximity analysis, show the effectiveness of the system in the site-selection process for Eldoret Municipality (Kenya).Two hierarchies were applied and from it one can calculate marginal benefits to cost ratios, (Saaty, 1990).Marginal benefit cost analysis along traditional lines can be carried out by a arranging costs in increasing order. The very first ratio is that of alternative with the smallest cost. Databases

needed for sewerage system management have been improved using GIS. During redevelopment, pipe network databases can be designed to accommodate flow volume simulations. The development of such a modeling capacity allows not only combined sewerage (storm water and wastewater) volume analysis but also prediction and scenario modeling. System objectives are thus: effective database management (storing many types of data, rapid query and retrieval capability and easy data maintenance/update). Prediction scenario modeling for decision support in management and planning.

Treating map layers as criteria in site screening and converting them to fuzzy maps according to appropriate linguistic values, resulting to a composite map obtained by intersecting all the criteria maps. The intersection of fuzzy sets is normally based on the use of the min-operator. Such that, Distance from human settlements receives the highest weight because its elements or sub criteria are primary targets to be protected from any adverse effects. It is also very natural for the public to reject a landfill site if it is located close to their homes or amenities. Therefore, the highest weight given in the preliminary screening reflects one of the attempts to avoid public resistance in the later stage of landfill development. Distance from water bodies reduces the possibility of contamination in surface water. Agricultural land and forest reserve areas are considered as protective lands. Thus, the distance from items in the natural resources group receives second priority. Optimum distance from roads is considered the third while topography receives lowest priority because landfill can be designed to fit various terrain characteristics and terrain that is clearly unsuitable is already excluded by the parameters used to define the membership function, (Charnpratheep, 1997).

Building models are key elements of a digital city concept that relates to large numbers of applications, such as urban planning, crime prevention, disaster mitigation, transportation optimization and sustainable development,(Xianfeng, 2013). The Digital Elevation Model (DEM) generation can be the base of digital terrain modeling for urban water management and analysis of sewerage flow volume. Simulations were carried out for both present and assumed future conditions, and with changed recurrence intervals specified (Yoo, 2005).

Manhole depths, pipe lengths, diameters and slopes are included in the Pima County GIS system, (Sier and Lansey, 2005).

As per Rules Establishing Minimum Standards Relating to Location, Design, Construction and Maintenance of Onsite Wastewater Treatment Systems, December, 2009, For Hydrogeology, Proposals to lower the groundwater table must be reviewed by the local reviewing agency, the Michigan Department of Public Health for Slopes; Since a relatively level area is needed for the installation of a standard soil absorption system, areas with 12% or greater slope are to be avoided.

Monitoring of sewage characteristics should be undertaken on an extended timeframe. This is essential where kinetic modeling of the sewage treatment process is to be undertaken. The variations would be due to internal water usage, infiltration/inflow and trade waste loadings (Planning Guidelines for Water Supply and Sewerage, April 2010).

Economy designers want to connect the maximum number of properties with the minimum length of sewer. However there are many changing circumstances that will influence the design requirements; climate change, growth including urban creep and creep of impermeable surfaces, maintenance including change in capacity due to siltation and cleaning. Simulation process using cut and try, the stages use different models to account for the anticipated catchment changes. By adopting the factor of safety principal to distinguish between uncertainty and the expected performance, at least 80% of all public and private decision-making is based on some spatial or geographic aspects (FIG, 2001).

From Arc GIS 10 help, Weighted Overlay (Spatial Analyst) Each raster is assigned a percentage influence. The cell values are multiplied by their percentage influence, and the results are added together to create the output raster. A floating-point raster must first be converted to an integer raster before it can be used in Weighted Overlay. The Reclassification tools provide an effective way to do the conversion. Each input raster is weighted according to its importance or its percent influence. The Weight is a relative percentage. The Weighted Overlay tool allows the calculation of a multiple-criteria analysis, between several raster's, Overlays several raster's using a common scale and weighing each according to its importance.

Spatial variables which could potentially affect the urban growth boundary in Kisii municipality: elevation, slope, distance to urban, distance to stream, and distance to road.

Another landscape consideration that can have a strong influence on the geometry of the urban growth boundary is the existence of reserve areas where development is prohibited by law in Kisii town. The basic assumption is that humans need various developments like roads to access areas where resources will be resulting in urban change, (Tayyebi et.al, 2013).

Information about the size and nature of contributing areas can be obtained instantly. If most local governments develop their own GIS database, Database information can include land cover pattern, pipe diameter, length and slope as well as large-scale digital topographic data, (Yoo, 2005).

Sewage carries pathogenic organisms that transmit diseases to human. It contains organic matter that causes odor and nuisance problems. Where a main sewerage system has not been provided like Bouti, Nyankongo, Nyamatara, Bobaracho, part of daraja mbili and Menyinkwa. This is evidenced by the captioned photograph in the Appendix , which shows pit latrines up on the hill and downstream in the same place they have a spring for drinking water as realized in a spring next to Daraja mbili primary school near Daraja mbili market in the study area.

## METHODOLOGY

### Area of Study

The study area sits within Kisii County formerly the larger Kisii District. Kisii is located in Western part of Kenya as shown in Figure 1 below , on Latitude of 0° 41' 0 S and Longitude:

34° 46' 0 E. As realized from the Kisii county development profile 2013 the town is surrounded by a hilly topography like that of Kionganyo 1,710m and Kiamwasi 1,785 m.

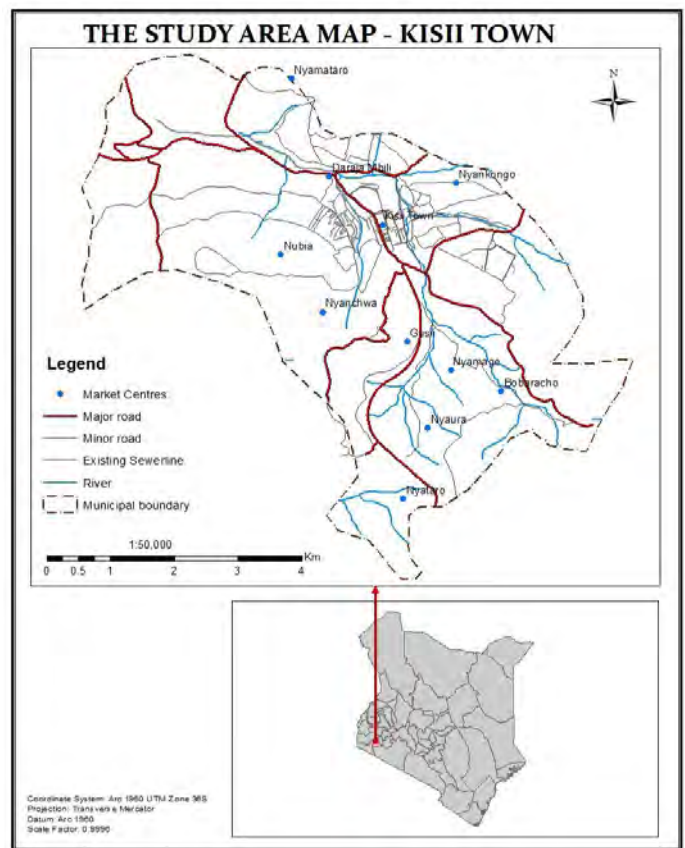

Figure 1: study area

The approach used for the database development and sewer line routing process is summarized in Figure 2. The first step involved the selection of the spatial and non-spatial factors affecting the sewer line route. Some of the factors considered included topography, surface geology, soils, roads, land use, existing sewer line, planning requirements and population densities. The geology and the soil types in the area are different thus present varying levels of construction hardships. Different cost was assigned to different soil type and the geology on the basis of ease of construction. The harder it is to dig through a particular type of rock the higher the cost. High relief terrain results in higher construction costs and increases the need for pump stations. Highly sloppy land was assigned high cost as the cost reduces as the slope reduces, thus high areas were avoided. The utilization of existing utility corridors and easements also ease the construction hardship. The nearer the sewer line is to a transportation corridor the less the disturbance to the environment and minimizes the construction cost associated with clearing of vegetation. The drainage of the area in terms of ground water sites, lakes, rivers will be taken into account in order to conserve the environment and protect the catchment areas. The population factors considered were; proximity to settlements and populated centers, in order to serve the population.

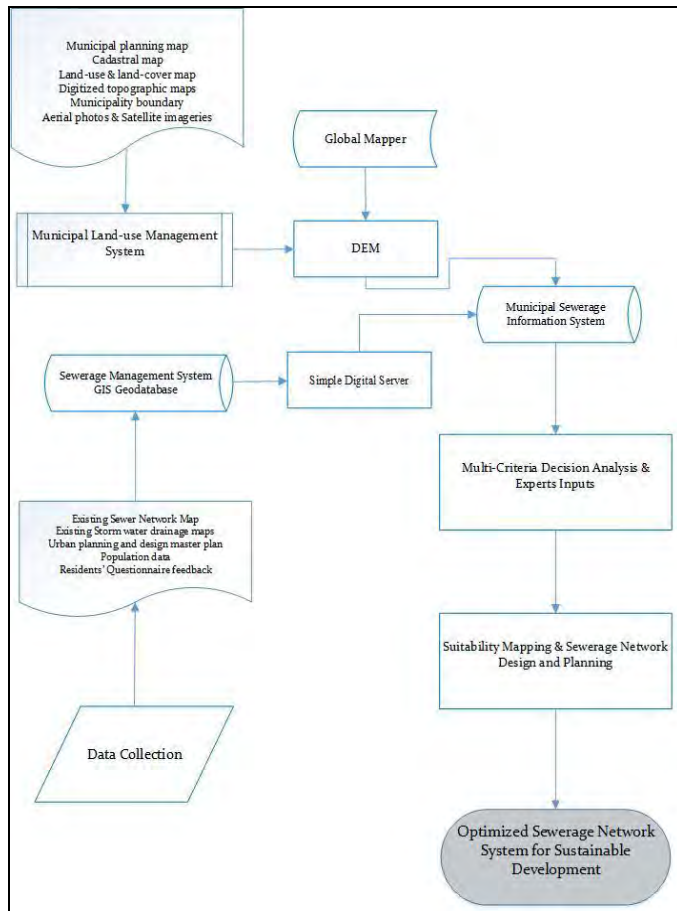

Figure 2: Flow chart of methodology

Table 1: Datasets and data sources

DATA	SOURCE	STATUS
Topographical maps (130/1&2)	S.O.K	Mosaicked & used
Quick bird 2013	S.O.K	Reprojected and used
Population data(1999&2009)	Central bureau of statics	Obtained, Analyzed and used.
Questionnaires	County staff(Experts) & customers(Users)	Fully analyzed/presented
DEM	USGS ASTER, RCMRD	Downloaded Processed
ROADS, WATER BODIES, DRAINAGE	KURA, KeRRA &Minsty of Water	Obtained and used

Data for the execution of this work was obtained from both primary and secondary data like Town development plans, Satellite Images; Quick bird images were collected for 2013 and topographical maps sources. Observation, questionnaires and interview were used to obtain the primary data including GPS or classical methods were also used. Remote sensing: The process includes the gathering of remote-sensing data like Satellite images: The delineated urban boundaries digitized from topographical maps 130/1 and 130/2 are then overlaid with spatial layers in GIS after digitizing to prepare input and output data; Preparation and running of models and the filtered optimal areas based on the AHP questionnaire to assign the conditional tool in the model depending on the priority vector realized from table 2 the matrix for 8, 9 and 10 as per the personal interviews with

engineer,( Engineer James Manyara and the water engineer respectively).

The layer (contour line minor) was projected into the project coordinate system (Arc 1960 UTM Zone 36S, Datum Arc 1960). The projected layer were then clipped using the Kisii Municipality boundary shape file as per Figure 2 above to get contour of the study area. Manhole points were also digitized from the existing topographical and urban planning maps and the new ones obtained by using a hand held GPS downloaded using map source software. Later clipped to get only those in the area of interest. Similarly, digital elevation model generated through the Global Mapper software to obtain contour data which was also clipped to the study area using the municipality boundary layer.

In slope generation, the slope was identified (gradient, or rate of maximum change in z-values) from each cell of a raster surface. Slope values ranges from 0 to 90 degrees. For percent rise, the range is 0 to near infinity. A flat surface (with no gentleness in terms of slope) is 0 percent (%). A 45 degree surface is 100 percent and as the surface becomes more and more vertical, the percentage rise becomes increasingly larger. The generated slope output was reclassified using the reclassify tool into 10 classes of equal intervals. The higher the ranks the more suitable an area is for sitting the underground substation for sewerage network while lower ranks for very steep areas that are unsuitable for selection.

Re-classed slope was weighted using the Weighted Overlay tool with an evaluation scale (common measurement scale) of 1 to 10 by 1 to cater for the 10 equal classes used in the reclassification process. Each class was weighted according to its importance which generated Cost Surface based on expert views.

The population of part of kisii town is as per figure 3.

## RESULTS AND DISCUSSIONS

Figure 3. Below summarizes the population trends in Kisii town and highlights the rapid population increase in the area. The increase in population demands a corresponding improvement in sewer services.

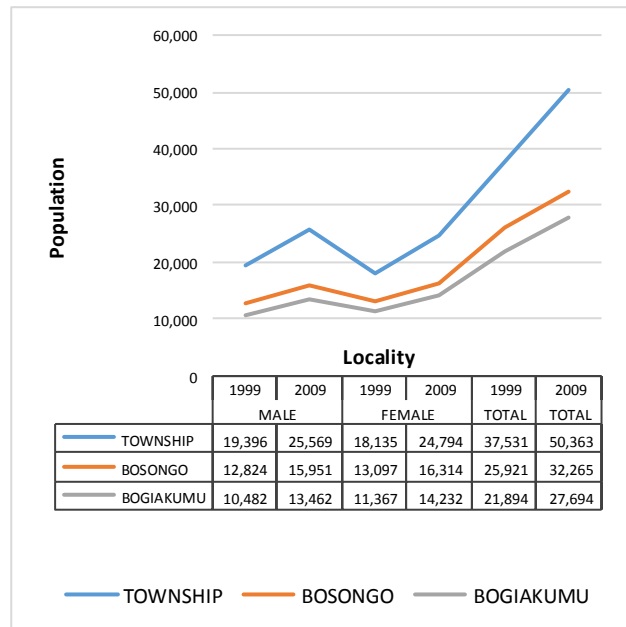

Figure 3: Population Trend of Part of Kisii Town

Questionnaires on sewerage were distributed to different stake holders to gather opinions on the current manual system resulting to figure 4 below.

From the analysis of the data resulted in table figure 4 which implied that the process of accessing data is very slow and many files go missing. Whereby the highest number of respondents (25.6%) reported of the process of being slow and (22.2%) reported of the current process being expensive and whereas (23.9%) reported of missing files among the bottlenecks.

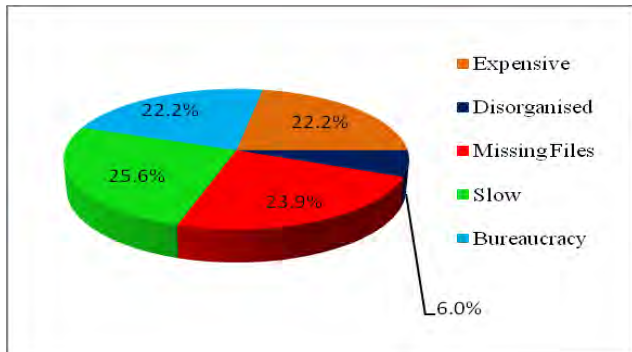

Figure 4: The bottlenecks of the current process

These results show that the current process of accessing data is not effective and therefore the need for the data to be computerized for easy accessibility.

Weights were calculated together with the consistency ratio. The results for each category of respondents and the corresponding consistency ratio are illustrated in this section. These Pair wise comparisons were generated based on scale of relative suitability according to Saaty (1980) From the expert response the optimal areas were ranked as kisii town (0.35), Daraja mbili (0.57) and other areas 0.08. From the weights based on pair wise comparison kisii town had a weight of 0.35, meaning that it has 35% influence, while

	Kisii Town	Daraja Mbili	Others	PRIORITY VECTOR
Kisii Town	1	1/3	9	0.35
Daraja Mbili	3	1	5	0.57
Others	1/9	1/5	1	0.08
Total	37/9	23/15	15	1

Daraja mbili has a weight of 0.57 meaning that it has 57% influence and other areas (0.08) meaning that they had a weight of 8%. as per Table 2.

Datasets including land use slope, population, and roads were clipped using the study area polygon, the Digital Elevation Model as shown on figure 6 was clipped to the study area, slope was then derived as per figure 7, followed by reclassification and adding the results to the weighted overlay table. The slope and population data were clipped to the study area, updated to the database, rasterized, reclassified then added to the weighted overlay table. Other datasets were clipped to the study area extents; a union was then done with the study area, updated both to the database, reclassified and added to the weighted overlay table.

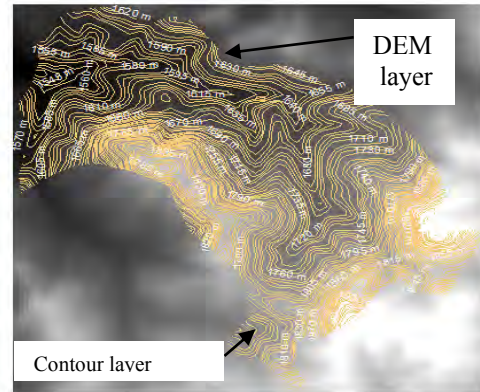

Figure 5: Generated DEM and Contour Layer

The results for reclassification are shown and illustrated using maps in the following section. Deriving datasets, such as slope, was the first step when building the sewer line route suitability model where each cell in the study area has a value for each input criteria. All the derived data sets need to combine so as to create a suitability map that will identify the potential locations for the new sewer route. The values in the datasets derived in previous steps were all floating-point, continuous datasets, categorized into ranges, and they had to be first reclassified so that each range of values is assigned. They were first reclassified to a common measurement scale, 1 to 10 for slope based on figure 5, as per figure 6. Figure 7 for population was generated based on population census of 1999 and 2009. The common measurement scale determined how suitable a particular each cell is for building routing a sewer route.

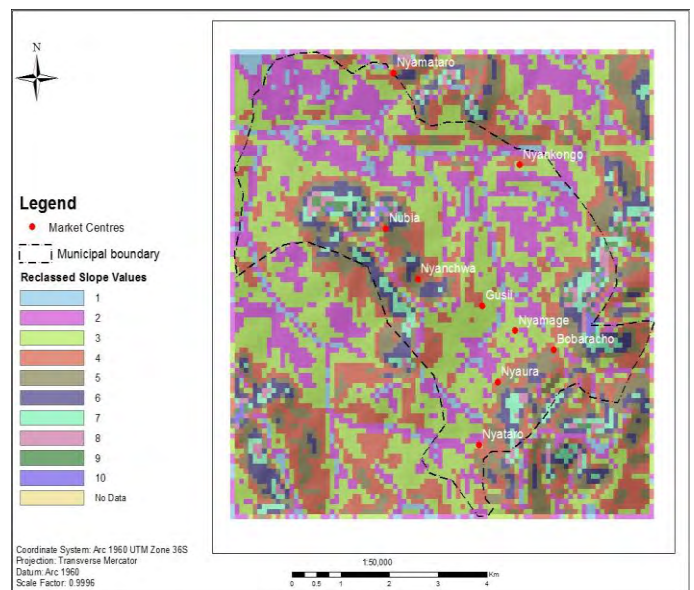

Figure 6: Re classified slope



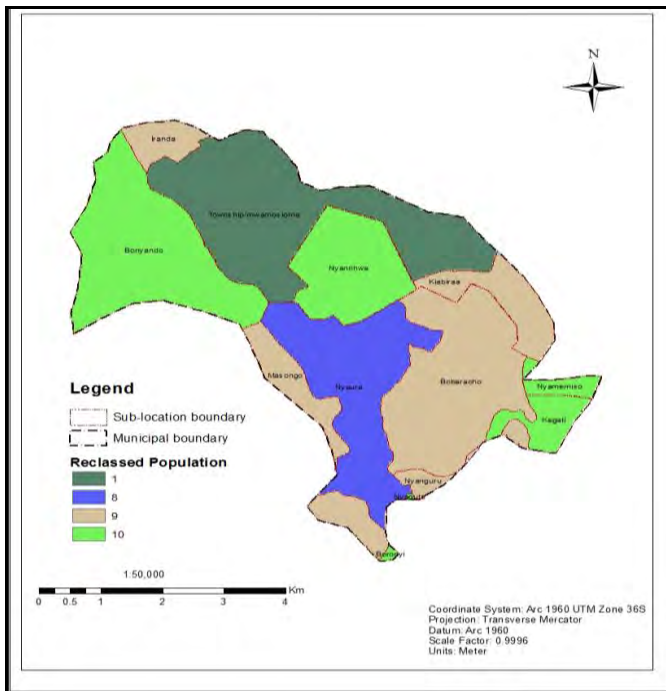

Figure 7: Re-classified population data

Higher values indicate less suitable locations for the route. Using the Weighted Overlay tool, the weight values calculated using analytical hierarchical process was assigned to each dataset. All the above processes were done using a model builder.

From the model, Cost Distance tool was used to record the accumulated cost of getting from each cell to the nearest source while the Cost path Tool was used to produce an output raster that recorded the least-cost path or paths from selected locations to the closest source cell defined within the accumulative cost surface, in

cost distance. The Output cost Back link which aided in defining the direction or identify the next neighboring cell (the succeeding cell) along the least accumulative cost path from a cell to reach its least cost source. This recorded the least-cost path or paths from selected locations to the closest source cell defined within the accumulative cost surface, resulting to map on figure 8.

The two main layers used in the suitability mapping of the sub-station site selection were, the re-classed population and re-classed slope as shown above on the weighted overlay tool. The two criteria were accorded equal influence of 50% each. These were overlaid to generate a cost surface map as Figure 9.

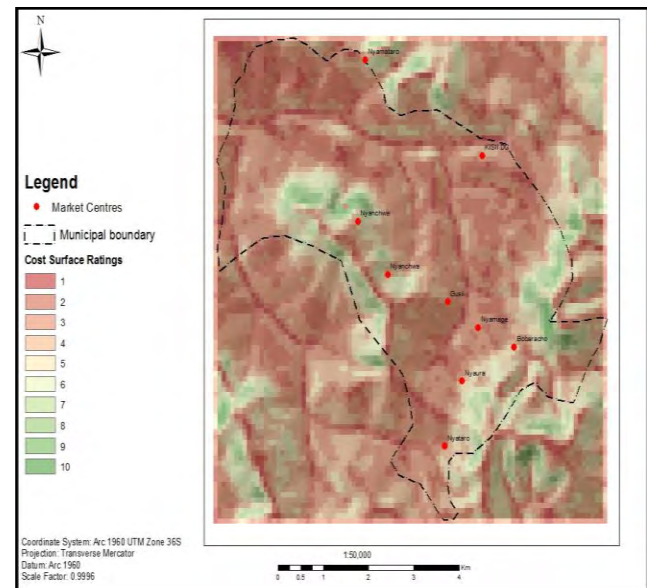
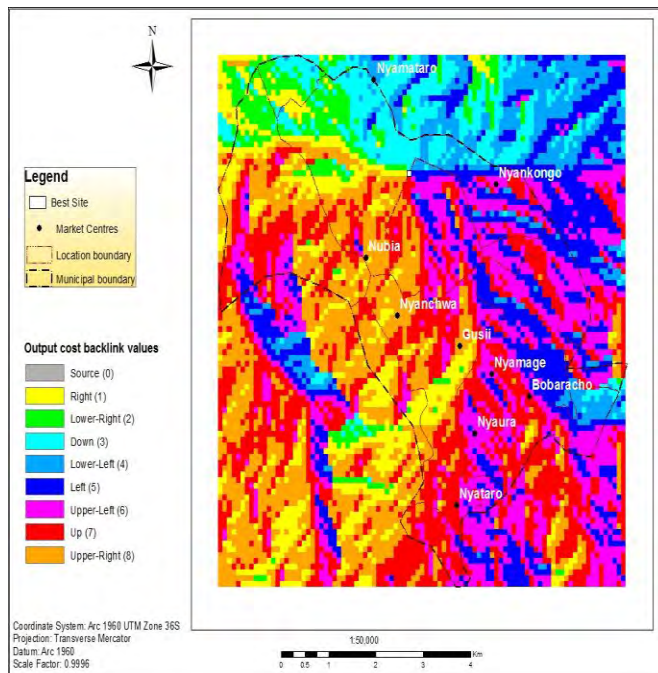
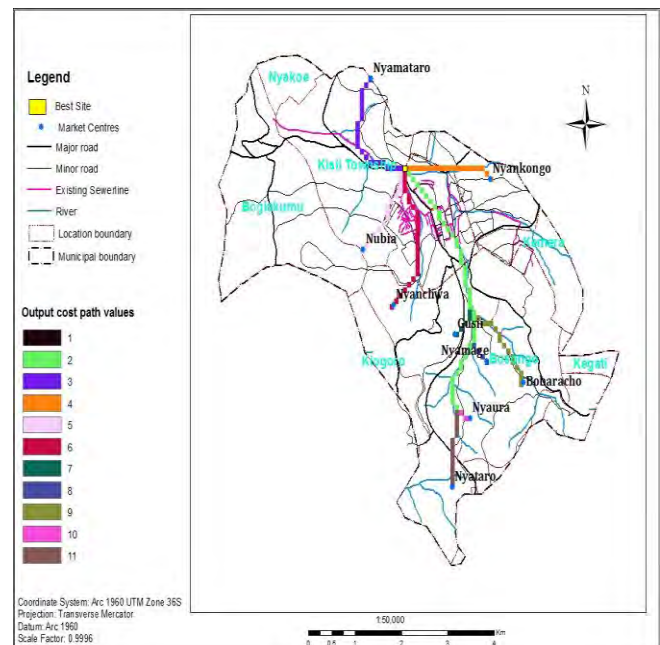

Figure 9: Cost surface generated from weighting

Market centers were used as the conveyor points and the optimal area as the convergence points; resulting from running the cost path tool using the output cost distance element. The analysis was based on market centers as the conveyor points and the optimal area as the



terms of  
Figure 8: Output cost Back link map



convergence points; resulting from running the cost path tool using the output cost distance element as figure 10.

Figure 10: Output cost path layer

Raster to poly line tool was used to generate the proposed sewer line, by running it aided in Converting raster dataset in figure 10 above to poly line feature resulting to a proposed sewer line as per Figure.11.

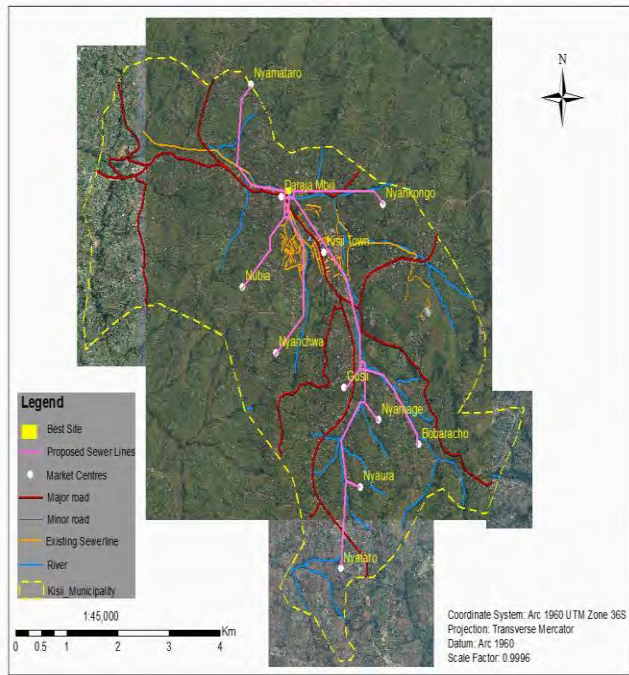

Figure 11: New Proposed Sewer Line Network for Kisii Municipality

### CONCLUSIONS AND RECOMMENDATIONS

The current sewer line and sewer infrastructure in Kisii is outdated and overstretched leading to environmental degradation and health risks. Kisii town, now a county headquarters therefore requires developing a sewerage management information system to guide future development.

To achieve this objective, primary and secondary datasets including Kisii Town development plans, High resolution satellite images, topographical maps, population data, questionnaires based interviews and GPS mapping were used in GIS environment to analyze and model the sewer system. The Analytical Hierarchical Process (AHP) which relies on the judgment of experts in assigning weights was used in optimizing the location of the proposed new sewer line. The model developed incorporated sewer line length, topography, land use, soil types, and populated areas, among others to identify an optimal sewer line location. Analytical Hierarchical Process (AHP) was used as a means to determine the relative preference of each factor.

Results show that seventy percent of the available manual data is not accessible, implying also that accessing the data is very slow and expensive and substantial numbers of files are either missing or misplaced. Questionnaire analysis results indicate that majority of those interviewed would prefer the computerization of the sewage information system for Kisii Town.

On the designing aspect, based on the response of the experts, using the Analytical hierarchical process proved that optimal areas lie near Daraja Mbili area as the base for the proposed sewer line.

Kisii town has fragile environments that have been in desperate need of programmes and projects that would provide alternatives on sewer management and thus help in improving productivity and bring about sustainable development of the available land. Given that there is a

population increase, this demands an increase in infrastructure and other utilities to cater for the overwhelming population pressure. Results indicate that the Current sewer line cannot be relied upon for future development while GIS techniques could be applied successful in order to select optimal sites for sewer management and generate optimal sewer lines. This confirms that modeling using geospatial tools could help decision makers at relevant agencies and authorities to combat various developmental problems.

This study therefore outlines the powerful capabilities of GIS techniques in handling digital data to select optimal sites sewer management for the ever growing Kisii County that is in need of more land that is not available. Hence there is desperate need of scientific and modern techniques that will help decision makers at relevant agencies and authorities to combat waterborne disease outbreak and save resources especially time and money in exploring suitable sites for waste water treatment in the county, sub counties.

### Recommendations

It is recommended that GIS techniques be adopted for routing purposes and not only for sewer line but for other different linear problems such as pipelines, and power lines by the Government of Kenya in order to save on operational and maintenance cost, protect the environment and reduce accidents. When routing a pipeline or power line for transmission of electricity, the same model can be used with a variation of the data sets and the rules applied to the variables. Rail lines, water pipes, road can be routed using the model developed. In order to improve the results of this study it's recommended that land ownership dataset and costing used for an existing sewer line be incorporated for further analysis. The cost of land along the proposed route should be determined in order to give an indication of compensation. Furthermore the model can be enhanced by adding the other variables that maximizes on public and government land. It's also recommended that an independent interface should be developed independent of ArcGIS for incorporating data in the model and executing it. The independent interface will enable non GIS professionals to use the model. The current model must be executed within ArcGIS model builder by an expert with knowledge of the model builder.

Finally, it is recommended that fieldworks must be carried out on the proposed optimal route for further investigations and fine tuning the route in order to ensure that there are no conflicting interests in the study that are not shown by the available GIS research data. The study was limited by the data available. By carrying out ground survey smaller details that were not discernable within the data resolution can be taken into account.

### ACKNOWLEDGMENT

I would like to thank my Co author Professor Charles Ndegwa Mundia, My parents Mr. Gideon Abuga Birai, Grace Nyanchama Abuga, my wife Beatrice Kwamboka and our family as a whole not forgetting Mr. Tuti Michira my friend and Grandfather for their support and selfless guidance throughout my studies. Much thanks to my colleagues Birir (KISIP), Rotich (NLC-Director), Kamunyu Mrs, Njuki, Kamau, Talam, Nanzala all of survey of Kenya and Lukoko of (SOK Trans mara), staff members at the Institute of IGGRoS at Dedan Kimathi University Nairobi Campus for their contributions in one way or the other towards the completion of this research work not forgetting the senior technologist Mr. Eric Kathurima Canton .

My special thanks also to my colleagues of the Survey of Kenya fraternity right from our current Director Mr. Cesare Mbaria for unconditional support, respect, love and endless support throughout my studies more especially Mr. Charles Mwangi the principal cartographer and Madam Jacinta Mutisya my current immediate supervisor together with Mr. Danson Muia Kivindu not forgetting Mr. Daniel Nyangweso and Mr. Rogers Gacewa my colleagues in the mapping department just to mention a few among many who have

been so helpful in this research. Special thanks to those who facilitated me with data like Mr. Mumina of regional center, Eng. James manyara of Kisii training center, Mr. Onger Robert of Kisii .

## APPENDIX: Photo (Pit Latrine/Spring of Water); Daraja Mbili\_Kisii



## REFERENCES

- [1] Amin Tayyebi, Phillips Christian Perry and AmirHosseinTayyebi 2013, Predicting the expansion of an urban boundary using spatial logistic regression and hybrid raster- vector routines with remote sensing and GIS, International Journal of Geographical Information Science, PP.37-41.
- [2] Armin Gruen 2013, SMART Cities: The need for spatial intelligence, Geo-spatial Information Science, Vol. 16, No. 1, pp 3-6.
- [3] Balogun, 2012. Optimal Oil Pipeline Route Selection using GIS : Community Participation in Weight derivation and Disaster Mitigation. International Conference on Future Environment and Energy, 8, pp.100-104.
- [4] Barbara Gerhager & Anwer Sahooley 2009, Reforming the Urban Water Supply and Sanitation (UWSS) Sector in Yemen, Water Resources Development, Vol. 25, No. 1, PP 29-46.
- [5] Dana Abu Sier and Kevin Lansey 2005, Monitoring sewage networks for sanitary sewer overflows, Civil Engineering and Environmental Systems, Vol. 22, No. 2, pp 123- 132.
- [6] Dubey, R., 2000. A Remote Sensing and GIS based least cost routing of pipelines Available at: <http://www.gisdevelopment.net/application/Utility/transport/utilitytr0025pf.htm> [Accessed June 27, 2013].
- [7] Evangelos Triantaphyllou and Stuart H. Mann. 1995, using the analytic hierarchy process for decision making in engineering applications: Some challenges, Inter'l Journal of Industrial Engineering: Applications and Practice, Vol. 2, No. 1, pp. 35-44.
- [8] Feldman, S.C., 1995. A Prototype for Pipeline Routing Using Remotely Sensed Data and Geographic Information System Analysis. , 4257(95).
- [9] Government of Kenya 2007, Kenya vision 2030, the popular version, PP 6 and 18-19.
- [10] HEALTH IN THE POST-2015 AGENDA 2013, Report of the Global Thematic Consultation On Health.
- [11] Henley, G. & Dresch, H., 2012. Pipeline Route Selection Process. Pipeline Route Selection Process, pp.1- 25. Available at: [wiki.iploca.com/display/rtswiki/Appendix+5.1.1](http://wiki.iploca.com/display/rtswiki/Appendix+5.1.1) [Accessed March 20,
- [12] HUANG Xianfeng 2013, Building reconstruction from airborne laser scanning data, Geo- spatial Information Science, Vol. 16, No. 1, PP 35-44.
- [13] International Federation of Surveyors (FIG) (2001). Standards and Surveyors: FIG's Past and Future Response. FIG ISO Bulletin.
- [14] I. Tamunobereton-ari; E. D. Uko, and O. I. Horsfall 2013, Correlational Analysis of Sewage Disposal Methods and Incidence Rates of Typhoid Fever and Cholera in Port Harcourt Metropolis, Nigeria, Journal of Emerging Trends in Engineering and Applied Sciences (JETEAS) 4(1), PP 16-23.
- [15] J. YOO. 2005, GIS-based simulation of urban sewerage flow volume, Urban Water Journal, Vol. 2, No. 1, PP 1 - 12.
- [16] Kiema J.B.K., M.A. Dang'ana and F.N. Karanja 2014, GIS-Based Railway Route Selection. For the Proposed Kenya-Sudan Railway: Case Study of Kitale-Kapenguria Section; Department of Geospatial & Space Technology University of Nairobi.
- [17] Kisii county development profile 2013, Ministry of devolution and planning
- [18] Kisii County Government the First County Integrated Development Plan, 2013-2017
- [19] Kherkpong Charnpratheep, Qiming Zhou and Barry Garner 1997, 'Preliminary landfill site screening using fuzzy geographical information systems', Waste Management & Research, no. 15, pp. 197-215.
- [20] Kyoto protocol to the united nations framework convention on climate change united nations, 1998, PP 3 and 20.
- [21] Muthusamy, N. and Dr. M. Ramalingam 2003, Environmental Impact Assessment For Urban Planning And Development Using Gis.
- [22] O'Leary, P. R., Canter, L. & Robinson, W. D. 1986, Land disposal In The Solid Waste Handbook: A Practical Guide .
- [23] P. Przewrocki, J. Kulczycka, Z. Wzorek, Z. Kowalski, K. Gorazda, M. Jodko 2004, Risk Analysis of Sewage Sludge - Poland and EU Comparative Approach, Polish Journal of Environmental Studies, Vol. 13, No. 2 pp 237-244.
- [24] S. I. Ovu (2008), Introduction to Environmental Health, 2nd Ed., God Giveth Printing and Publishing Company, Nigeria.
- [25] UN-HABITAT 2008, Lake Victoria Region Water and Sanitation Initiative Final project report
- [26] Saaty, T. L. 1980, The Analytic Hierarchy Process: Planning, Priority Setting, Resource Allocation. New York, U.S.A.
- [27] Saaty, T.L. (1990). An Exposition of the AHP in Reply to the Paper 'Remarks on the Analytic Hierarchy Process', Management Science, 36: 259-268
- [28] Saaty, T.L. 1994, Fundamentals of Decision Making and Priority Theory with the AHP. RWS Publications, Pittsburgh, PA, U.S.A.
- [29] Saha, A.K. et al., 2005. GIS based route planning in landslide prone areas. International Journal of Geographical GIS, 19(10), pp.1149-1175.
- [30] Steven J. Burian, Stephan J. Nix, Robert E. Pitt, and S. Rocky Durrans 2000, Urban Wastewater Management in the United States: Past, Present, and Future, Journal of Urban Technology, Volume 7, Number 3, PP 33-62.
- [31] Suresh, K.S. & Nonis, C.N., 2007. Investigation of an AHP based Multi Criteria Weighting Scheme for GIS Routing of Cross Country Pipeline Project. In 24th International Symposium on Automation & Robotics in Construction.
- [32] Taylor, 2007. Evaluation of the assessment process for major projects: a case study of oil and gas pipelines in Canada. Impact Assessment and Project Appraisal, 25(2), pp.123- 137.
- [33] The constitution of Kenya (Kenya), 27 August 2010 available at <http://refworld.org/docid/4c8508822.html> [Accessed October 27, 2014].
- [34] UN-HABITAT September 2008, Lake Victoria Region Water and Sanitation Initiative Final project report.
- [35] Wang TAO 2013 Interdisciplinary urban GIS for smart cities: advancements and opportunities, Geo-spatial Information Science, Vol. 16, No. 1 , PP 25-34.
- [36] Water-borne diseases and access to safe water for Sub-Saharan Africa populations 2010-2011
- [37] Yashon O. Ouma, Emmanuel C. Kipkorir and Ryutaro Tateishi 2011, MCDA-GIS integrated approach for optimized landfill site selection for growing urban regions: an application of neighborhood-proximity analysis, Annals of GIS Vol. 17, No. 1, PP 43-62

# Microwave Enhanced Organic Synthesis Green Chemistry- A Study in Transesterification

Anil Kumar, Abraham Chirchir, David K Some, Kirimi H Kiriamiti

**Abstract** - Use of microwaves as an alternate heat source to replace conventional heating has been studied in organic synthesis. Microwave irradiation results in faster reaction rates, cleaner production, thereby reducing energy consumption. This also leads to better environmental impacts and is considered green chemistry. This Paper reviews application of microwave irradiation in transesterification reactions for production of biodiesels. Transesterification of Croton *Megalocarpus* oil using homogeneous sodium hydroxide catalyst was carried out using conventional heating in a water bath, and in a microwave oven. Synthesis of fatty acid methyl ester (FAME) was studied for the reaction variables catalyst concentration, methanol to oil molar feed ratio and reaction time. Results indicated that reaction time was reduced to about 2% for a similar yield when microwave irradiation was employed instead of convective heating. During convectional heating, a FAME yield of 96% corresponded to a methanol-to-oil molar ratio of 6:1, catalyst of 1 %, temperature of 70°C, and reaction time of 60 minute. During microwave irradiation, a yield of 92% was obtained when methanol-to-oil molar ratio was 9:1, catalyst concentration 0.5 %, and reaction time 1 minute. FAME was analyzed through gas chromatography.

**Keywords**- Green chemistry, microwave irradiation, convective heating, transesterification, *Croton Megalocarpus*, FAME

## I. INTRODUCTION

Microwave irradiation has been employed in laboratory studies for organic synthesis over a long period of time. One of the earliest reported study was for hydrolysis of benzamide to benzoic acid by Gedye et al. [1],[2].

Reaction was carried out both under conventional heating and microwave irradiation, and reaction rate increased by 5 to 1000 times by microwave irradiation. Solvents are sometimes used in organic synthesis reactions to control the reaction temperature for extended time period. Use of such a solvent was eliminated when microwave irradiation was used for esterification of fumaric acid with ethanol at 423-523 K with reaction time reduced to 10 min [3]. Elimination of solvents have positive environmental effect and is green chemistry. In Romania, the Institute of Macromolecular Chemistry (Iasi, Romania) developed a new “greener” method for the synthesis

of copolymers of maleic anhydride with the use of microwaves. In this method free radicals are formed which advance the copolymerization of maleic anhydride with vinyl monomers [4]. Microwave applications in organic synthesis are numerous and have been published in form of books [5] – [10].

Reaction times are reduced when conventional heating is replaced by microwave irradiation. This leads to energy saving and better environmental impact. Present paper gives the general nature of microwaves and highlights the distinguishing features with conventional heating. Literature review covers the application of microwave irradiation to transesterification reactions. Experimental work presented is the transesterification of croton *megalocarpus* oil using conventional and microwave irradiations, using homogeneous catalyst.

## II. MICROWAVE IRRADIATION

Electromagnetic irradiation in the frequency range of 0.3-300 GHz constitute microwaves. Microwave ovens for domestic use operate at a frequency of 2.45 GHz to avoid interference with telecommunication frequencies, but other frequency allocations do exist. One reason for this is that near to this frequency, the microwave energy absorption by liquid water is maximum. Energy associated with microwaves ( $1.24 \times 10^{-6} - 1.24 \times 10^{-3}$  eV) is lower than the energy of Brownian motion ( $2.7 \times 10^{-3}$  eV at 310K) which is not strong enough to even break chemical bonds, hence as such microwaves cannot induce chemical reactions. Microwaves as an energy source, produce heat by their interaction with the materials at molecular level without altering the molecular structure. In conventional heating, heat transferred to the sample volume is utilized to increase temperature of the surface of the vessel followed by the internal materials. Therefore, a large portion of the energy supplied through conventional energy source is lost to the environment through conduction of materials and convective currents. Heating effect in the conventional method is heterogeneous and depends on viscosity, conductive, convective heat transfer coefficients and density, resulting in higher surface temperatures [11]. Microwave heating offers several advantages over conventional heating such as non-contact heating (reduction of overheating of material surfaces), energy transfer instead of heat transfer (penetrative radiation), reduced thermal gradients, material selective and volumetric heating, fast start-up and stopping and reverse thermal effect, i.e. heat starts from the interior of material body. Microwaves

---

Anil Kumar\*, Dept of Chemical & Process Engineering, Moi University, P.O. Box 3900-30100, Eldoret  
Abraham Chirchir, Dept of Chemical & Process Engineering, Moi University, P.O. Box 3900-30100, Eldoret  
David K Some, Commission for Higher Education, Red Hill Road, Gigiri.P.O. Box 54999 – 00200, Nairobi  
Kirimi H Kiriamiti, Garissa University College, Bazaar Building 15<sup>th</sup> Floor, P.O. Box 63056 - 00200, Nairobi  
\*Corresponding Author - E-mail: akumar@mu.ac.ke, anil3900@gmail.com

transfer energy into materials by dipolar polarization, ionic conduction and interfacial polarization mechanisms to cause localized and rapid superheating of reaction materials. If a molecule possesses a dipole moment, when it is exposed to microwave irradiation, the dipole tries to align with the applied electric field. Since the electric field is oscillating, the dipoles constantly try to realign to follow this movement. At 2.45 GHz, molecules have time to align with the electric field but not to follow the oscillating field exactly. If a molecule is charged, then the electric field component of the microwave irradiation moves the ions back and forth through the sample while also colliding them into each other. This movement again generates heat. In addition, because the energy is interacting with the molecules at a very fast rate, the molecules do not have time to relax and the heat generated can be, for short time, much greater than the overall recorded temperature of the bulk reaction mixture. In essence, there would be instantaneous localized superheating. In terms of biodiesel production, the resultant effect could include: more effective heating, fast heating of catalysts, reduced equipment size, faster response to process heating control, faster start-up, increased production, and elimination of process steps [12]. Traditionally, chemical reactions for organic synthesis are carried out by conductive/convective heating with an external heat source. This is a comparatively slow and inefficient method for transferring energy into the system since it depends on the thermal conductivity of the various materials that must be penetrated, and results in the temperature of the reaction vessel being higher than that of the reaction mixture leading to thermal gradients.

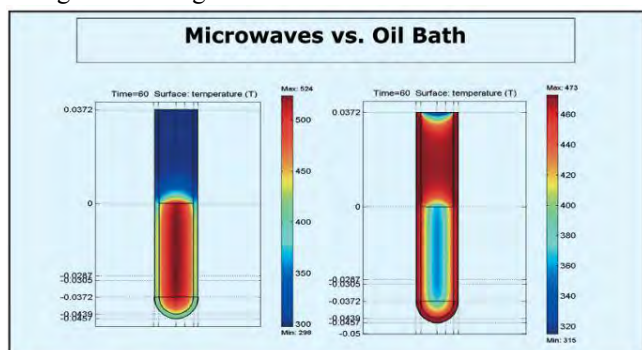

Fig 1: Temperature profile in microwave irradiation and conventional (oil bath) heating after 60s [13].

If microwave energy is used as a means of heating, provided at least one solvent or reactant material is able to convert electromagnetic energy to heat energy, heating is limited to reactants alone leading to a better heat transfer efficiency. Fig 1 gives a temperature profile for conventionally heated and microwave heated batch reactor after 60s of heating. For microwave heating, reactants are heated uniformly whereas for conventional heating the only reactor body is heated and the reactant sample is still cold [13].

### III. MICROWAVE IRRADIATION IN TRANSESTERIFICATION REACTIONS

Three heating methods have been used in transesterification reactions: conventional heating, supercritical heating and microwave irradiation. Microwave heating employs moderate reaction temperatures at atmospheric conditions, similar to that of conventional heating, and requires shortest reaction times. Supercritical heating usually does not need a catalyst but the method requires expensive specialized laboratory equipment. In microwave irradiation catalysts are needed to accelerate reaction rates. Heat losses are lowest in microwave irradiation resulting into high process efficiency. Methanol is a strong microwave absorption material due to the presence of OH group therefore production of Fatty acid methyl esters (FAME) is accelerated by microwave heating [14]. Microwave irradiation reduces the activation energy of the reaction resulting into faster reaction rates. Various feed stocks have been used for production of FAME in batch and continuous reactors. Scientific microwave ovens and modified domestic microwave ovens have been used for irradiation. In one of the earliest works, Lertsanthapornsuk [15] obtained an optimum conversion of FAME from used cooking oil with homogeneous NaOH catalyst (1%), methanol to oil molar ratio of 9:1, and a reaction time of 10s. In a similar study using waste cooking oil and KOH catalyst, best yield of 81% FAME was obtained at 2% KOH, 1:4 (v/v) methanol:oil ratio, at 401K in 9 min [16]. Used cooking oil was converted into FAME by Saifuddin and Chua [17] in a two-step process using 0.5% and 1% NaOH catalyst, and 6:1 methanol to oil molar ratio. Microwave irradiation greatly reduced the reaction time and increased FAME yield. Chen et al. [18] compared performances of NaOH and Sodium methoxide catalysts for used cooking oil microwave transesterification. Biodiesel yields were higher with sodium methoxide catalyst for similar reaction conditions. Barnard *et al.* [19] studied the viability of microwave irradiation for continuous production of biodiesel using used and fresh vegetable oils. A flow rate of 7.2 L/min in a 4 L vessel gave a conversion of 98.9% using 1% KOH catalyst and 6:1 methanol to oil ratio. Microwave heating was found to be more energy efficient than using conventional heating. A continuous production of FAME using coconut, rice bran and used palm oil was carried out by Lertsanthapornsuk [20] using 1% NaOH and 9:1 methanol to oil ratio. 100% conversion was obtained within 30s for coconut oil, 94% conversion for rice bran oil and 83% for used palm oil. When used palm oil was diluted with kerosene, conversion increased to 92% in 30s. Leadbeater and Stencil [21] obtained a 98% FAME yield using 5% NaOH/KOH, 6:1 methanol to oil ratio at 323K and a time of 1 min for triolein. Rapeseed oil was transesterified using KOH catalyst using microwave irradiation in a two-step process. Highest yield of 93.7% corresponded to 313K, 1% KOH and 1 min reaction time in the first step; and 323K, 1% KOH and reaction time of 5 min reaction time in second step [22]. Jatropha curcas oil was transesterified in a microwave oven. Maximum FAME conversion was 86.3% at 30:1 methanol to oil ratio, 4% NaOH catalyst at a temperature of 328K [23]. In another study for the same oil, 89.7% FAME yield was obtained at 1% NaOH catalyst, 12:1 methanol to oil ratio, 338K and a time of 7 min

[24]. When KOH was employed as catalyst for *Jatropha curcas* oil, a FAME yield of 97.4% was obtained for 1.5% catalyst, 7.5:1 methanol to oil ratio, 338 K and a time of 2 min under microwave irradiation. In the same study, a conventional heating required a total reaction time of 150 min corresponding to a 99.8% FAME yield. Free fatty acid (FFA) of oil was earlier reduced by esterification with 0.3%  $H_2SO_4$ , at 333K for 90 min, as a pretreatment step [25]. Kapilan [26] used a two-step esterification/ transesterification by using  $H_2SO_4$  and KOH catalysts to obtain biodiesel from crude *Jatropha curcas* oil using microwave irradiation. Biodiesel yield was 0.91 g/g of oil using 1.4% NaOH, 0.24:1 methanol to oil mass ratio and a reaction time of 1 min. Liao and Chung [27] studied two-step *Jatropha curcas* oil transesterification in a continuous flow reactor. In the first step high FFA was neutralized by  $H_2SO_4$ , and in the second step transesterification was carried out under microwave using NaOH catalyst. Optimum FAME yield was 99.63% at 1.26% NaOH, 10.74:1 methanol to oil ratio, and flow rate of 1.62 ml/min. Yellow horn oil was transesterified using a homogeneous KOH catalyst [28] and heterogeneous heteropolyacid and alkaline ion exchange resin solid catalysts under microwave irradiation [29], [30]. Homogeneous catalyst gave a maximum FAME yield of 96% at 1% catalyst, 6:1 methanol to oil ratio, at 333K and 6 min; whereas solid catalyst gave a FAME yield of about 96% at 1% catalyst, 12:1 methanol to oil ratio, at 333K and time of 10 min. Used frying oil was transesterified by Reefat et al. [31] under microwave and a FAME yield of 100% was obtained using 1% KOH, 6:1 methanol to oil ratio, at 338K, and a time of 2 min. Similar yield was obtained in 60 min under conventional heating. Soybean and corn oils were transesterified in microwave using heterogeneous diphenylammonium catalysts. Maximum FAME yield of about 100% was obtained for corn oil after 20 min, and 80% yield was obtained for soybean oil after 17.5 min [32]. Hernando et al. [33] transesterified soybean oil in batch and flow reactors under microwave. During batch reaction, 2.3g oil with 0.03 g NaOH and 1.27 ml of methanol gave a maximum 97% FAME yield in 1 min; and during flow reaction highest yield of 97% FAME corresponded to 18.4g oil, 0.24g NaOH, 10.16 ml methanol and a time of 1 min. Refined Cottonseed oil was transesterified under microwave using KOH catalyst and best results were obtained at 1.5% KOH, 6:1 methanol to oil ratio, at 333 K for a time of 30 min giving a FAME yield of 92.7% [34]. Castor oil was transesterified under microwave using acid solid  $H_2SO_4/C$  catalyst. Best reaction conditions corresponded to 94% FAME at 5% catalyst, 12:1 methanol to oil ratio and a time of 60min [35]. Castor oil was also transesterified using solid  $Al_2O_3/50\%KOH$  and  $SiO_2/50\% H_2SO_4$  catalysts under microwave irradiation. For similar yields, microwave irradiation needed time from 5 to 30 min, whereas conventional heating needed time from 1h to 3h [36]. A high FFA crude palm oil was transesterified in a two-step process under microwave irradiation. In the first step 4%  $H_2SO_4$  was used to esterify and reduce FFA using a 24:1 molar ratio of ethanol to FFA for 60 min. In the second step 1.5% KOH was

used to transesterify using 4:1 ethanol to oil ratio and a time of 5 min, to give a ethyl ester content of 97.4% [37]. Mazo and Rios [38] used ion exchange resins to reduced the FFA of crude palm oil through esterification and later used potassium carbonate catalyst to obtain fatty acid ester under microwave, using isopropyl, isobutyl, 2-butyl and isopentyl alcohols. Transesterification studies involving enzyme biocatalysts have also demonstrated better FAME yields under microwave irradiation [39]. Saifuddin et al. [40] studied production of biodiesel from high FFA used cooking oil using Lipase enzyme/acid catalyzed hybrid process. Lipase enzyme was used to hydrolyze the oil initially, and later transesterified with 2.5%  $H_2SO_4$  at 323K for one hour, using 15:1 methanol to oil ratio, to obtain 88% conversion. *Pongamia pinnata* oil was transesterified using a two-step process under microwave irradiation using NaOH and KOH catalysts. When KOH was used, a 1% KOH, 10:1 methanol to oil ratio gave yields of 80% and 90% in steps one and two, and reaction time was 4-5 min [41]. Optimum catalyst concentration in case of NaOH was 0.5% giving a yield of 96% for 6:1 methanol to oil ratio, at 333K, and a time of 5 min for microwave irradiation and 3 h for conventional heating [42]. Rice bran and soybean oils were transesterified under microwave irradiation using ethanol and methanol using homogeneous catalysts. Results indicated that microwave irradiation reduced reaction time and catalyst requirement when compared to conventional heating [43]. Homogeneous NaOH catalyst was used to transesterify safflower oil under microwave irradiation and a 98.4% conversion was obtained using 1% catalyst, 10:1 methanol to oil ratio in 6 min [44]. Hsiao et al. [45] used nano CaO catalyst to transesterify soybean oil using microwave irradiation obtaining a 96.6% conversion at 7:1 methanol to oil ratio, 3% catalyst, at 338K and a time of 60 min. Microwave irradiation was found to be more efficient than conventional heating. CaO in form of calcined industrial egg shell waste was used as a solid catalyst to transesterify palm olein oil under microwave irradiation. FAME yield of 96.7% was obtained at 15% catalyst, 18:1 methanol to oil ratio in a time of 4 min [46]. Kamath et al. [47] used a two step process to transesterify high FFA karanja oil under microwave irradiation. In step one, FFA was reduced from 8.8% to 1.11% using 3.73%  $H_2SO_4$  catalyst in 190s. Transesterification was carried out using 1.33% KOH in step two, 33.4% methanol to oil for a time of 150s, giving a FAME yield of 91.4%. Satyanarayanareddy and Regupathy [48] used a low FFA karanja oil and transesterified under microwave using KOH catalyst using both batch and flow process, and Response surface methodology was used to identify optimal conditions. Kumar et al. [49] transesterified *Pongamia pinnata* (karanja) oil under microwave using two catalysts, NaOH and KOH. When NaOH was used, maximum FAME yield of 97.5% was obtained after 10 min, at 0.5% NaOH, at 333K and 6:1 methanol to oil ratio. In case of KOH catalyst, highest FAME yield was 96% for 1% KOH in 5 min for similar temperature and methanol ratio. Soybean oil was transesterified in a continuous flow reactor under microwave irradiation by Encinar et al. [50] Over 99% conversion of FAME was

obtained using 1% KOH, 12:1 methanol to oil ratio, at 343K, in a 2 min reaction time. Patil et al. [51] studied the microwave transesterification of *Camelina sativa* oil over homogeneous and heterogeneous alkaline earth oxide and sol-gel derived catalysts. For optimal FAME yield, the various catalyst concentrations were 1% KOH, 0.5% NaOH, 1.5% BaO, 2% SrO; reaction times were 1 min for KOH and NaOH, and 4 min for BaO and SrO; with 9:1 methanol to oil ratio. Energy requirement for conventional heating was estimated to be 18 times higher than that by microwave method. Patil et al. [52] used dry and wet algal biomass to produce FAME using microwave irradiation. Microwave method increased the yield, reduced reaction time, and decreased the energy consumption for separation and purification steps [53], [54]. From literature review it shows that microwave irradiation is a technology which is more efficient and environmentally superior as compared to conventional heating. Unfortunately all the reported works are of lab studies. There is no known commercial biodiesel production using microwave irradiation possibly due to scale-up design challenges.

#### IV. MATERIALS AND METHODS

Croton *megalocarpus* oil was solvent-extracted from croton nuts in department of chemical & process engineering lab, and also obtained from Help Self-Help Centre Nairobi. Analytical grade sodium hydroxide pellets were obtained from Gelsup, Nairobi. Analytical grade methanol was from Sigma Aldrich. GC grade solvents n-heptane, hexane; GC standards methyl heptadecanoate, triolein, methyl myristate, methyl palmitate, methyl stearate, methyl oleate, methyl linoleate were from Sigma Aldrich. Equipment included Water bath (Stuart RE 300B, accuracy  $\pm 1^\circ\text{C}$ ), Mechanical stirrer (Stuart SS10, 0-2000 rpm), Domestic microwave oven (Shivaki, SMW-103, 1300W), Voltage regulator, Microwave leak detector, Magnetic stirrer (Hanna), Thermocouple thermometer (Hanna HI9055), Centrifuge (Hettich D-7200). FAME was analyzed by a Gas chromatograph (MRC GC3420A) with flame ionization detector, capillary column Agilent CP-Sil 88 (60m x 0.25mm x 0.36mm, coating 0.2 $\mu\text{m}$ ); carrier gas was nitrogen and other gases were hydrogen and air. Data analysis was done using Peak-ABC chromatography data handling system. Teflon<sup>®</sup> tubing, standard laboratory glassware were used.

For transesterification with conventional heating, a 3-neck round bottom flask (250 ml) was used as the batch reactor. The flask was kept in a constant temperature water bath. A water-cooled reflux condenser was used to condense methanol vapours. Mechanical stirrer was fitted with a stainless steel impeller of diameter 0.03m, operating at 750 rpm. The mixing speed was sufficient to eliminate mass transfer resistance and ensure complete mixing. Fig 2 gives the schematic diagram of experimental setup for conventional heating.

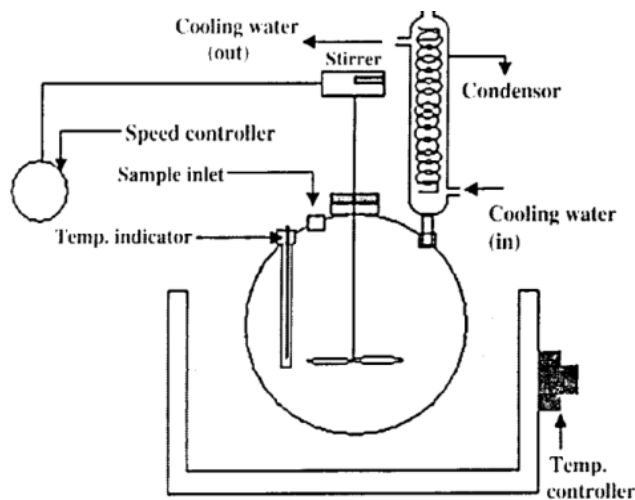

Fig 2: Experimental schematic diagram- conventional heating

For studies with microwave irradiation, a domestic microwave oven was modified as shown in Fig 3a and 3b. A voltage regulator was used to control the input power, an electromagnetic stirrer with Teflon<sup>®</sup> coated stirring magnet was used to provide the stirring, temperature sensor was a Teflon<sup>®</sup> covered thermocouple. Water cooled condenser was used to condense methanol. Modified oven was tested for microwave leakage using a microwave leak-detector and the irradiation levels were found to be within the safely limit of 5 mW/cm<sup>2</sup>. Three-neck round bottom flask (250 ml) was used as a reactor. Oven also contained a water reservoir (500 ml beaker/ conical flask) to act as a sink to absorb excess microwave irradiations. Samples were drawn using a hypodermic syringe.



Fig 3a: Experimental setup- microwave irradiation

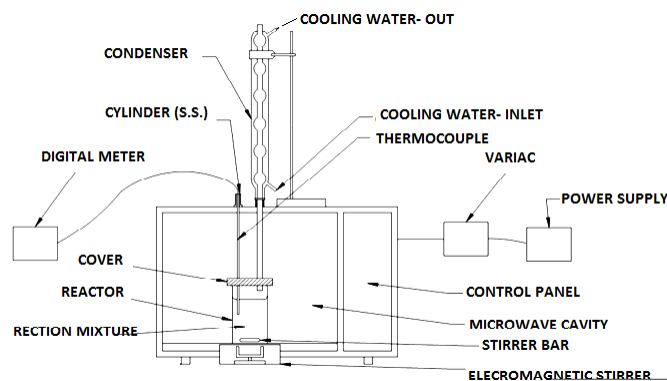

Fig 3b: Experimental schematic diagram-irradiation

For experiments with conventional heating, amount of croton *megalocarpus* oil was added to and heated in the water bath to the reaction temperature. Weighed amount of sodium hydroxide catalyst and volume of methanol were heated separately to temperature till the catalyst completely dissolved. The sodium hydroxide-methanol solution was then added to the oil. The mechanical stirrer was immediately started, and the reaction timed at this point. At the end of the desired reaction time, the round bottom flask was immersed in ice water to quench the reaction. The contents were then transferred to a separating funnel and some warm water added and contents shaken. The separating funnel was kept in a stand allowing the two phases to separate. Oily phase containing FAME was the top phase. Glycerol, unreacted methanol and the added water formed the bottom aqueous phase. Aqueous phase was removed and discarded. The oily phase was similarly shaken and washed twice, or more times, with warm water till the aqueous phase was free from any alkalinity. This was tested by adding phenolphthalein indicator to a small portion of aqueous phase till it became colourless. The oily phase containing FAME was dried in an oven at 363 K (90°C) for 1 hour to remove any dissolved methanol. The dried FAME sample was stored in a deep freezer before GC analysis.

For microwave irradiation, procedure was almost similar to the case of conventional heating. Methanol and NaOH were mixed prior to being added to the reactor in microwave. Stirring was vigorous to prevent hot-spots within the reacting media. After an experimental run, the oven was allowed to cool to ambient temperature before reuse.

The product sample was analyzed by gas chromatography for total FAME according to EN-14103 (BRUKER Chemical Analysis Application Note # CA-270358). Approximately 250mg of sample was accurately weighed in a 10ml vial, and 5 ml of methyl heptadecanoate solution (10 mg/ml- as internal standard) was added using a pipette. 1 µL of this was injected in a split ratio 1:100. Nitrogen carrier gas flow rate was 45 ml/min, hydrogen 30 ml/min, and air 300 ml/min. Initial column temperature was 393K (120°C) for 2 mins, and the ramped at the rate of 10K/min to 493K (220°C) and kept there. Injector temperature was 523K (250°C) and Detector

temperature was 573K (300°C). Run time was 30 min. FAME content was calculated using the following formula:

$$\text{FAME} = \left( \frac{\sum A - AEI}{AEI} \right) \left( \frac{CEI \times VEI}{m} \right) \times 100 \%$$

where,  $\sum A$  = total peak area for methyl esters,  $AEI$  = peak area of methyl heptadecanoate (internal standard),  $CEI$  = concentration of methyl heptadecanoate solution (mg/ml),  $VEI$  = volume of methyl heptadecanoate solution (ml),  $m$  = mass of the sample (mg)

Fig 4 gives an illustrative chromatogram for Croton *megalocarpus* FAME.

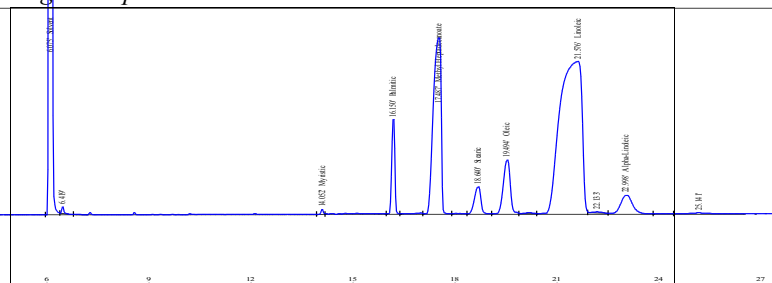

Fig 4: FAME Chromatogram ( Peaks: 1- Solvent Hexane, 2- Myristic acid, 3- Palmitic acid, 4- Methyl heptadecanoate (IS), 5- Stearic acid, 6- Oleic acid, 7- Linoleic acid, 8- Linolenic acid)

## V. RESULTS AND DISCUSSIONS

### A. Studies with conventional heating

Effect of operation variables, catalyst concentration, methanol to triglyceride molar ratio and reaction time, on FAME yield was studied.

#### 5.1.1 Effect of catalyst concentration of FAME yield

Transesterification of Croton *megalocarpus* oil was carried with varying catalyst concentrations. Batch consisted of 30 ml of Croton *megalocarpus* oil (FFA = 1.7), methanol-to-oil ratio of 6:1, reaction temperature 70°C (343K), reaction time 2 hrs., and NaOH concentrations of 0.5, 1, 1.5, 2 mass% respectively. Fig 5 gives the FAME yield as a function of NaOH concentration.

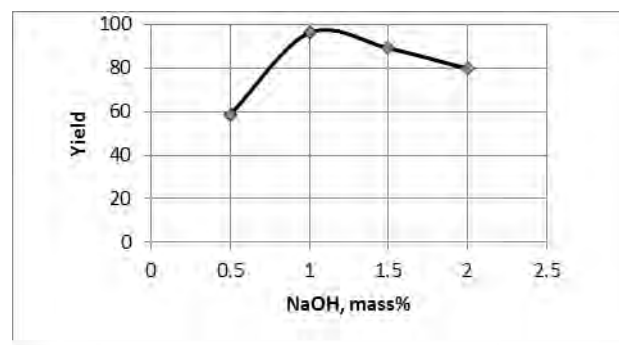

Fig 5: FAME yield as a function of NaOH concentration

A FAME yield of 58.6% was obtained for NaOH concentration of 0.5 mass%. The yield increased to 96.0% when NaOH concentration was raised to 1 mass%. Further increase in NaOH concentration resulted in drop in yield. Yields for 1.5 and 2 mass% were 89 and 79.6% respectively.



The highest FAME yield corresponded to 1 mass% of catalyst. At higher ( $> 1$  mass%) catalyst concentrations, soap formation was observed bringing about problems in phase separation and recovery of FAME dropped resulting in lower yields.

#### 5.1.2 Effect of methanol to triglyceride molar ratio on FAME yield

Methanol to oil molar ratio was varied as 3:1, 6:1, 9:1, 12:1, 15:1. Batch consisted of 30 ml of *Croton megalocarpus* oil (FFA = 1.7), NaOH catalyst 1% by mass of oil. Reaction temperature was 70°C (343K), and reaction time 2 hrs. Fig 6 gives the FAME yield as a function of methanol: oil ratio.

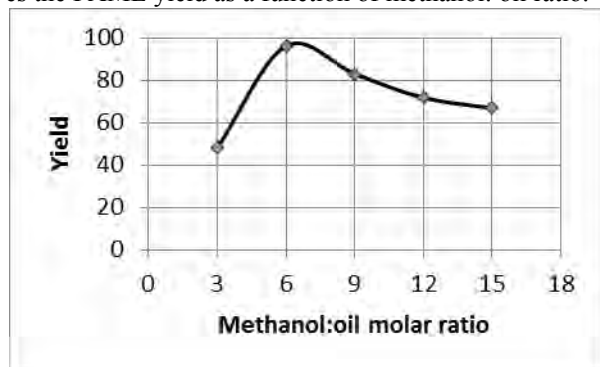

Fig 6. FAME yield as a function of methanol: oil ratio

The reaction stoichiometry requires three moles of methanol to one mole of triglyceride. However, due to reversible nature of the reaction an excess amount of methanol is used to promote the forward reaction. FAME yield was 48.1% for a 3:1 methanol:oil ratio. Yield increased to 96% when the ratio was increased to 6:1. At higher ratios the yield began to decline, and the highest ratio of 15:1 corresponded to a 66.8% yield. When methanol is in large excess, the unreacted fraction mixes with product glycerol, hindering the separation. The glycerol in the solution drives the equilibrium back to the left-side resulting in lower yields. It is also reported that in large excess of methanol, glycerol forms an emulsion with FAME, leading to glycerol-FAME separation problems and lowering the yield [55]. Lastly, large surplus of methanol reduces the effective percentage of catalyst in the reaction mixture, thereby lowering the yield [56].

#### 5.1.3 Effect of reaction time on FAME yield

Fig 7 gives the FAME yield as a function of time at a reaction temperatures of 70°C (343K) for the reaction period of 3 hrs.

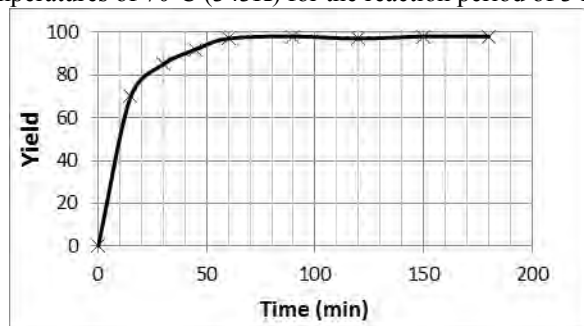

Fig 7: Variation of Yield with time

Yield increased with time in the initial period but became almost constant after 1 h of reaction time. Maximum yield after 3 h was 98% of FAME.

#### B. Studies with microwave irradiation

Operating variables for FAME yield studied were (i) Catalyst concentration, (ii) Methanol-to-triglyceride molar ratio (iii) Reaction time. Stirring was through an electromagnetic stirrer operating at full speed. Mixing was very vigorous and mass transfer resistance was ruled out.

#### 5.2.1 Effect of catalyst concentration on FAME yield

Transesterification of *Croton megalocarpus* oil was carried with varying NaOH concentrations. Batch consisted of 25 ml of *Croton megalocarpus* oil (FFA = 1.7), methanol to oil ratio of 6:1, microwave power- full, reaction time of 60s. NaOH concentrations were 0.5, 1.0, 1.5, 2.0 mass% of oil. NaOH was mixed with methanol before being added to the oil. Fig 8 gives the FAME yield as a function of NaOH concentration.

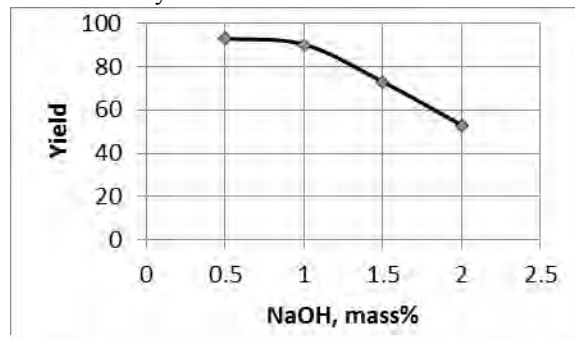

Fig 8: FAME yield as a function of NaOH concentration

Highest yield of 93% was obtained when catalyst concentration was 0.5 mass%. As the catalyst concentration was increased to 1.0, 1.5, 2.0% the yield dropped to 90.3, 73, 53% respectively. At catalyst concentrations of 1.5 and 2%, the product FAME consisted of soap which needed several washings. Excess sodium hydroxide reacts with oil to form soap, which lowers the yield of FAME. No significant soap was noticed for 1 mass% NaOH concentration.

#### 5.2.2 Effect of methanol: triglyceride molar ratio on FAME yield

Methanol to oil molar ratio was varied as 6:1, 9:1, 12:1, 15:1. Batch consisted of 25 ml of *Croton megalocarpus* oil (FFA = 1.7), NaOH catalyst 1% by mass of oil. Microwave power was at full, and reaction time was 60s. Fig 9 gives the FAME yield as a function of Methanol: oil ratio.

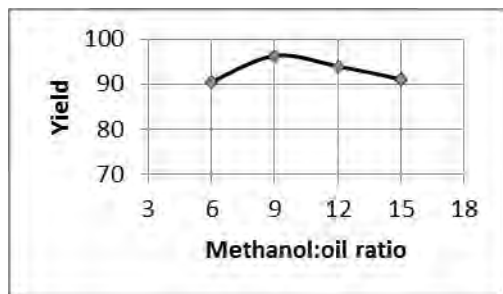

Fig 9. FAME yield as a function of Methanol: oil ratio

An excess of methanol is used in transesterification to drive the reaction in forward direction. Yield was 90.5% at the ratio of 6:1. Yield increased to 96.5% when the methanol was increased to 9:1 molar ratio. At higher methanol-to-oil ratios of 12:1 and 15:1, yield did not increase any further, instead a slight drop was observed. Yield for 15:1 ratio was found to be 91.1%. Reasons for a decrease in yield at higher methanol concentration are: excess methanol mixing with glycerol leading to poor separation, glycerol forming an emulsion with FAME in presence of excess methanol leading to poor separation, and finally large methanol reducing the effective concentration of the catalyst in the reaction mixture.

### 5.2.3 Effect of reaction time on FAME yield

Batch consisted of 25 ml of Croton *megalocarpus* oil (FFA = 1.7), methanol-to-oil ratio of 6:1, 1 mass% NaOH and full microwave power. Reaction times were varied from 30s – 180s. The Variation of FAME yield with reaction time is given in Fig 10.

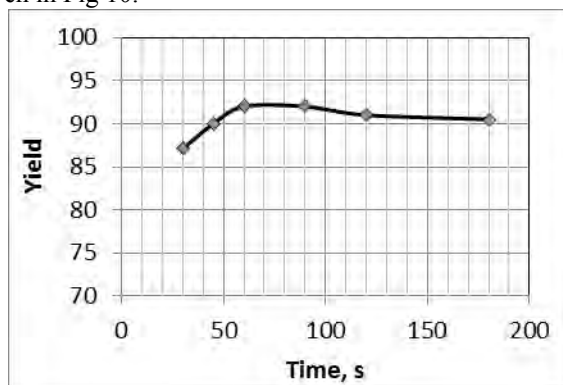

Fig 10: Effect of reaction time on Yield (Full Power)

FAME yield increases as the reaction time was increased from 30s to 45s. However, the yield soon stabilized and attained a constant value ranging from 90 – 92%. Between reaction times of 45s and 60s, the increase in yield was only 2%, from 90% to 92% of FAME; which dropped to 91% at a time of 120s, and to 90.5% at a time of 180s. This goes to show that the reaction attains a steady state at times above 45s, and the yield becomes constant.

## VI. CONCLUSIONS

Microwave irradiation for transesterification has been studied on lab scale for a number of vegetable oils. All studies have concluded that microwave irradiation is superior to

conventional convective heating as it saves substantial reaction time, which in turn is saving in energy. Savings in energy has direct positive environmental effects. Published literature shows substantive variance in reported data for optimal FAME yield. The parameters affecting optimum FAME yield mainly are the type of oil, the catalyst and methanol content. Transesterification of Croton *megalocarpus* oil using homogeneous NaOH catalyst under conventional heating gave a maximum yield of 96% for 1% NaOH, 6:1 methanol to oil ratio, in 60 min, at a temperature close to boiling point of methanol. Similar study under microwave irradiation gave a yield of 92% for 0.5% NaOH, 9:1 methanol to oil ratio, in 1 min. It was found that for similar yield, microwave irradiation used half the catalyst, needed 50% more methanol, and saved time by (1/60) times. Surplus methanol in this case can easily be distilled off. Washing of homogeneous catalyst (NaOH) is a major environmental challenge in such reactions, and microwave irradiation has an advantage since the catalyst amount needed is reduced by half. Faster reaction rates under microwave lead to savings in reaction time and energy. Microwave irradiation is a greener option for biodiesel production.

## REFERENCES

- [1] R. N. Gedye, F. E. Smith, K. C. Westaway, *Can J Chem*, Vol 66, p 17, 1988.
- [2] R. N. Gedye, W. Rank, K. C. Westaway, *Can J Chem*, Vol 69, p 706, 1991.
- [3] M. Nuchter, B. Ondruschka, W. Bonrath, A. Gum, *Green Chem*, Vol 6, p 128, 2004.
- [4] I. Popescu, G.C. Chitanu, "Synthesis of Maleic Anhydride copolymers by conventional and non conventional methods". *2nd International IUPAC, Conference on Green Chemistry*, 14-19 September, 2008, Moscow, Russia.
- [5] K. R. Desai, V. R. Kanetkar. *Green Chemistry Microwave Synthesis*. Global Media, New York, 2010.
- [6] D. Bogdal (Ed). *Microwave-assisted Organic Synthesis*. Vol. 25. One Hundred Reaction Procedures. (Tetrahedron Organic Chemistry). Elsevier, New York, 2006.
- [7] A. Loupy (Ed). *Microwaves in Organic Synthesis*. Wiley-VCH, West Sussex, UK, 2002 (1st), 2006 (2nd Ed).
- [8] C. O. Kappe, D. Dallinger, S. S. Murphree. *Practical Microwave Synthesis for Organic Chemistry. Strategies, instruments, and protocols*. Wiley-VCH, West Sussex, UK, 2009.
- [9] J. P. Tierney, P. Lidstrom. *Microwave Assisted Organic Synthesis*. Wiley-Blackwell, London, 2005.
- [10] M. Larherd, Olofsson (Eds). *Microwave Methods in Organic Synthesis*. Springer, Berlin, 2006.
- [11] Refaat, A.A., El Sheltawy, S.T. 2008. Time factor in microwave-enhanced biodiesel production, *WSEAS Transactions on Environment and Development*, 4(4), 279-288.
- [12] Gude, V.G., Patil, P., Martinez-Guerra, E., Deng, S., Nirmalakhandan, N. 2013. Microwave Energy potential for biodiesel production. *Sustainable Chemical Processes*, 1:5, 1-31.
- [13] C. O. Kappe, D. Dallinger, *Nat Rev Drug Discov* 2006 Jan, 5(1), 51-63.
- [14] J. M. N. van Kasteren, A. P. Nisworo, *Resources Conservation and recycling*, Vol 50, p442, 2007
- [15] V. Lertsathapornasuk, R. Pairintra, K. Krisnangkura, S. Chindaruksa, "Direct conversion of used vegetable oil to biodiesel and its use as an alternative fuel for compression ignition engine". *Proceedings of the 1st international conference on energy and green architecture*. 2003. SE091-096.
- [16] F. Motasemi, F. N. Ani. "The production of biodiesel from waste cooking oil using microwave irradiation". *Jurnal Mekanikal*, 2011, pp 61-72.
- [17] N. Saifuddin, K. H. Chua. "Production of ethyl ester (biodiesel) from used frying oil: optimization of transesterification process using

- microwave irradiation". *Malaysian Journal of Chemistry*. 2004, Vol 6, pp 077-82.
- [18] K. S. Chen, Y. C. Lin, K. H. Hsu, H. K. Wang. "Improving biodiesel yields from waste cooking oil by using sodium methoxide and a microwave heating". *Energy*, 2012. Vol 38, pp 151-156.
- [19] T. M. Barnard, N. E. Leadbeater, M. B. Boucher, L. M. Stencel, B. A. Wilhite. "Continuous-flow preparation of biodiesel using microwave heating". *Energy & Fuels*, 2007, Vol 21, pp 1777-1781.
- [20] V. Lertsathapornasuk, P. Ruangying, R. Pairintra, K. Krisnangkura. "Continuous transesterification of vegetable oils by microwave irradiation". *Proceedings of 1<sup>st</sup> conference on energy networks, Thailand RE 11-1-RE 11-4*, e-nett.sut.ac.th/download/RE/RE11.pdf, access 10-4-2011.
- [21] N. E. Leadbeater, L. M. Stencel. "Fast, easy preparation of biodiesel using microwave heating". *Energy Fuels*, 2006, Vol 20, pp 2281-83.
- [22] N. Azcan, A. Danisman. "Microwave assisted transesterification of rapeseed oil". *Fuel*, 2008, Vol 87, pp 1781-8.
- [23] Z. Yaakob, I. S. Sukarman, S. K. Kamarudin, S. R. S. Abdullah, F. Mohamed. "Production of biodiesel from *Jatropha curcas* by microwave irradiation". International Conference on Renewable Energy Sources, 2008.
- [24] Z. Yaakob, B. H. Ong, M. N. S. Kumara, S. K. Kamarudina. "Microwave assisted transesterification of *Jatropha* and waste frying palm oil". *International Journal of Sustainable Energy*, vol 28, pp 195-201, 2009.
- [25] S. A. El Sherbiny, A. A. Refaat, S. T. ElSheltawy. "Production of biodiesel using the microwave technique". *Journal of Advanced Research*, vol 1, pp 309-14, 2010.
- [26] N. Kapilan. "Preparation of biodiesel from vegetable oil using microwave irradiation". *Acta Polytechnica*, vol 52, no 1, 2012].
- [27] C. C. Liao, T. W. Chung. "Analysis of parameters and interaction between parameters of the microwave assisted continuous transesterification process of *Jatropha* oil using response surface methodology". *Chem Eng Res & Design*, vol 89, pp 2575-81, 2011.
- [28] Y. Zu, S. Zhang, Y. Fu, W. Liu, Z. Liu, M. Luo. "Rapid microwave assisted transesterification for the preparation of fatty acid methyl esters from the oil of yellow horn (*Xanthoceras Sorbifolia* Bunge.). *European Food Research & Technology*, vol 229, pp 43-9, 2009.
- [29] S. Zhang, Y. G. Zu, Y. J. Fu, D. Y. Zhang, T. Efferth. "Rapid microwave assisted transesterification of yellow horn oil to biodiesel using a heterogeneous solid catalyst". *Bioresource Technol.*, vol 101, pp 931-836, 2010.
- [30] J. Li, Y. J. Fu, X. J. Qu, W. Wang, M. Luo, C. J. Zhao, Y. G. Zu. "Biodiesel production from yellow horn (*Xanthoceras Sorbifolia* Bunge.) seed oil using ion exchange resin as heterogeneous catalyst". *Bioresource Technology*, vol 108, pp 112-8, 2012.
- [31] A. A. Reefat, S. T. El Sheltawy, K. U. Sadek, "Optimum reaction time, performance and exhaust emissions of biodiesel produced by microwave irradiation". *International Journal of Environmental Science & Technology*, vol 5, pp 315-322, 2008.
- [32] M. W. Majewski, S. A. Pollack, V. A. Curtis-Palmer. "Diphenylammonium salt catalysts for microwave assisted triglyceride transesterification of corn and soybean oil for biodiesel production". *Tetrahedron Letters*, vol 50, pp 5175-7, 2009.
- [33] J. Hernando, P. Leton, M. P. Matia, J. L. Novella, J. Alvarez- Builla. "Biodiesel and FAME synthesis assisted by microwaves: Homogeneous batch and flow processes". *Fuel*, vol 86, pp 1641-1644, 2007.
- [34] N. Azcan, A. Danisman. "Alkali catalyzed transesterification of cottonseed oil by microwave irradiation". *Fuel*, vol 86, pp 2639-2644, 2007.
- [35] H. Yuan, B. L. Yang, G. L. Zhu. "Synthesis of biodiesel using microwave absorption catalysis". *Energy Fuels*, vol 23, pp 548-52, 2009.
- [36] G. Perin, G. Alvaro, W. Westphal, L. H. Viana, R. G. Jacob, E. J. Lenardao, M. G. M. D'Oca. "M.G.M. Transesterification of castor oil assisted by microwave irradiation". *Fuel*, vol 87, pp 2828-2841, 2008.
- [37] K. Suppalakpanya, S. B. Ratanawilai, C. Tongurai. "Production of ethyl ester from crude palm oil by two-step reaction with a microwave system". *Fuel*, vol 89, pp 2140-4, 2010.
- [38] P. C. Mazo, L. A. Rios. "Esterification and transesterification assisted by microwave of crude palm oil. Heterogeneous catalysis". *Latin American Applied Research*, vol 40, pp 343-349, 2010.
- [39] B. M. Nogueira, C. Carretoni, R. Cruz, S. Freitas, P. A. Melo Jr, R. Costa-Felix, J. C. Pinto, M. Nele. "Microwave activation of enzymatic catalysts for biodiesel production". *Journal of Molecular Catalysis B: Enzymatic*, vol 67, pp 117-21, 2010.
- [40] N. Saifuddin, A. Z. Raziah, H. N. Farah. "Production of biodiesel from high acid value waste cooking oil using an optimized Lipase enzyme/acid-catalyzed hybrid process, *E-Journal of Chemistry*, vol 6(S1), S485-S495, 2009.
- [41] I. V. Kamath, M. B. Ragupathi, Saidutta. "Microwave-assisted batch synthesis of *Pongamia* biodiesel". *Biofuels*, vol 1, pp 847-54, 2010.
- [42] R. Kumar, G. R. Kumar, N. Chandrashekar. "Microwave assisted alkali-catalyzed transesterification of *Pongamia pinnata* seed oil for biodiesel production". *Bioresource Technology*, vol 102, pp 6617-20, 2011.
- [43] A. Kanitkar, S. Balasubramanian, M. Lima, D. Boldor. "A critical comparison of methyl and ethyl esters production from soybean and rice bran oil in the presence of microwaves". *Bioresource Technology*, vol 102, pp 7896-902, 2011.
- [44] M. Z. Duz, A. Saydut, G. Ozturk. "Alkali catalyzed transesterification of safflower seed oil assisted by microwave irradiation". *Fuel Processing Technology*, vol 92, pp 308-13, 2011.
- [45] M. C. Hsiao, C. C. Lin, Y. H. Chang. "Microwave irradiation assisted transesterification of soybean oil to biodiesel catalyzed by nanopowder calcium oxide". *Fuel*, vol 90(5), pp 1963-1969, 2011.
- [46] P. Khemthong, C. Luadthong, W. Nualpaeng, P. Changsuwan, P. Tongprem. "Industrial eggshell wastes as the heterogeneous catalysts for microwave-assisted biodiesel production". *Catalysis Today*, vol 190, pp 112-116, 2012..
- [47] H. V. Kamath, I. Regupathi, M. B. Saidutta. "Optimization of two step karanja biodiesel synthesis under microwave irradiation". *Fuel Processing Technology*, vol 92, pp 100-5, 2011.
- [48] Y. Satyanarayana, I. Regupathi. "Microwave assisted batch and continuous transesterification of karanja oil: optimization of process parameters". *Biomass Conversion and Biorefinery*, Vol 3, Issue 4, pp 305-317, Dec 2013.
- [49] R. Kumar, G. R. Kumar, N. Chandrashekar. "Microwave assisted alkali-catalyzed transesterification of *Pongamia pinnata* seed oil for biodiesel production". *Bioresource Technology*, vol 102, pp 6617-6620, 2011.
- [50] J. M. Encinar, J. F. Gonzalez, G. Martinez, N. Sanchez, A. Pardo. "Soybean oil transesterification by the use of a microwave flow system". *Fuel*, 2011.
- [51] P. D. Patil, V. G. Gude, L. M. Camacho, S. Deng. "Microwave-assisted catalytic transesterification of *Camelina sativa* oil". *Energy Fuels*, vol 24, pp 1298-1304, 2010.
- [52] P. D. Patil, V. G. Gude, A. Mannarswamy, S. Deng, P. Cooke, S. Munson-McGee, P. Lammers, N. N. Khandan. *Bioresource Technology*, vol 102 (2), p1399, 2011.
- [53] P. D. Patil, V. G. Gude, A. Mannarswamy, P. Cooke, S. Munson-McGee, N. Nirmalakhandan, P. Lammers, S. Deng. "Optimization of microwave-assisted transesterification of dry algal biomass using response surface methodology". *Bioresource Technology*, doi:10.1016/j.biortech.2010.09.046, 2010.
- [54] P. D. Patil, H. Reddy, T. Muppaneni, A. Mannarswamy, T. Schuab, F. O. Holguin, P. Lammers, N. Nirmalakhandan, P. Cooke, S. Deng. "Power dissipation in microwave-enhanced *in situ* transesterification of algal biomass to biodiesel". *Green Chemistry*, vol 14, pp809-818, 2012.
- [55] S. Jain, M. P. Sharma, S. Rajvanshi, "Acid base catalyzed transesterification kinetics of waste cooking oil". *Fuel Processing Technology*, vol 92, pp 32-38, 2011.
- [56] M. E. Bambase, N. Nakamura, J. Tanaka, M. Matsumura, "Kinetics of hydroxide catalyzed methanolysis of crude sunflower oil for the production of fuel-grade methyl esters". *Journal of Chemical Technology and Biotechnology*, vol 82, pp 273-280, 2007.

# Design of Adaptive Noise Canceler in Foetal Electrocardiogram Signal Extraction Using Simulated Annealing Algorithm

Kevin Mwongera, Kibet Langat, E. N. Ndung'u

**Abstract-** Adaptive noise cancellation is an active research field. The main objective of adaptive noise cancellation is to estimate the corresponding noise signal and consequently subtract it from the corresponding corrupted signal plus noise signal to obtain the noise free signal. Continuous monitoring of foetal heart condition during pregnancy is of great medical significance. Electro Cardio Gram (ECG) is used to record changes in heartbeat thus can diagnose any heart malfunction. The obtained foetal ECG (FECG) signal is usually severely contaminated by maternal cardiogram (MECG), and other external interferences. The resultant low signal to noise ratio of foetal ECG makes it difficult to analyze it effectively. This paper analyses use of adaptive noise cancelling techniques in filtering noisy FECG using simulated annealing algorithm. A comparison is made between use of the simulated annealing algorithm and the commonly used Least Mean Squares (LMS) algorithm. Obtained correlation values are used as the performance measure. The simulated annealing algorithm is found to perform better than the LMS algorithm. The entire analysis is made through simulations in Matlab software.

**Key words-** Adaptive noise cancellation, Electro Cardio Gram, signal to noise ratio, simulated annealing algorithm, least mean squares algorithm

## I. INTRODUCTION

Contamination of a signal of interest by other undesired signals (noise) is a problem encountered in many applications. In most applications, the desired signal has changing characteristics which requires an update in the filter coefficients for a good performance in signal extraction. Since conventional digital filters with fixed coefficients do not have the ability to update their coefficients, adaptive digital filters are used to cancel the noise.

Adaptive noise cancellation filters have been of immense interest due to their self-reconfiguration properties [1]. When some prior knowledge about the statistics of a signal under consideration is available, an optimal filter for such

application can be easily developed (referred to as the Wiener Filter which minimizes the respective Mean Square Error (MSE)). MSE is the difference between the developed optimal filter output and the desired response [1]. If this prior knowledge is unavailable, adaptive filtering algorithms have the ability to adapt the corresponding filter coefficients to be well-matched with the involved signal statistics.

Adaptive filtering algorithms have been used in many fields such as signal processing, communications systems and control systems [1].

Adaptive filtering process consists of two major steps; the filtering process which generates an output signal (response) from the input signal, and an adaptation process; which adjusts the filter coefficients intelligently in order to result in an optimal output.

## II. ADAPTIVE NOISE CANCELLATION

Adaptive filters are the major component of adaptive noise cancellation schemes. In communication systems, the term filter refers to a system that reshapes the frequency components of an input signal to generate an output signal with desirable features. Basically an ANC would be of the nature illustrated in Figure 1 below. [1], [2].

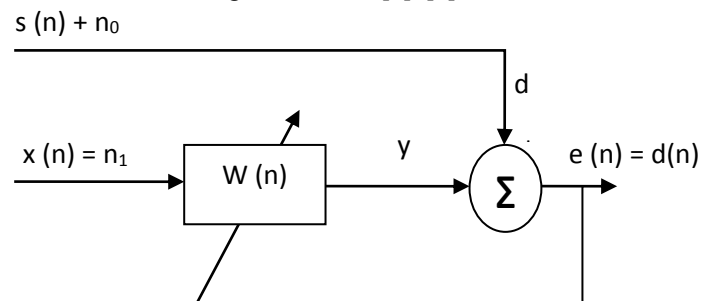

Fig. 1: Adaptive noise canceller

In this configuration, the input  $x(n)$  (a noise source  $n_1(n)$ ), is compared with a signal  $d(n)$ , which consists of a signal  $s(n)$  corrupted by another noise signal ( $n_0(n)$ ). Input  $x$  is highly correlated with the noise  $n_1$  and lowly correlated with signal  $s$ . The output  $e = (d-y)$  is ideally free of noise  $n$ . The optimal

Mr. Kevin Mwongera, Department of Telecommunication Engineering, JKUAT. (phone: +254724173870; e-mail: kmwongera@jkuat.ac.ke).

Dr. Kibet Langat, Department of Telecommunication Engineering, JKUAT. (phone: +254724833749; e-mail: kibetlp@jkuat.ac.ke).

Dr. E. N. Ndung'u, Department of Telecommunication Engineering, JKUAT. (phone: +254721366349; e-mail: enndungu@yahoo.com).

adaptive filter coefficients lead to the error signal being a noiseless version of the signal  $s(n)$ .

### III. ADAPTIVE NOISE CANCELLERS PERFORMANCE MEASURES

#### A. Convergence Rate

The Convergence rate determines the rate at which the filter converges to the corresponding optimal state. Fast convergence rate, whilst ensuring stability, is a desired characteristic of an adaptive system.

#### B. Computational Complexity

Computational complexity is particularly important in real time adaptive filter applications. When a real time system is being implemented, there are hardware limitations that may affect the performance of the system. A highly complex algorithm will require much greater hardware resources than a simplistic algorithm.

#### C. Filter Length

The filter length of an adaptive system is inherently tied to many of the other performance measures. The length of the filter specifies how accurately a given system can be modeled by the adaptive filter, the longer the better. In addition, the filter length affects the convergence rate, by increasing or decreasing computation time/ complexity.

### IV. LEAST MEAN SQUARES ALGORITHM

The LMS minimizes the Mean Square Error function  $J(n) = E\{|e(n)|^2\}$  iteratively by updating filter weights in a manner negative to the direction of the gradient of the MSE function ( $-\nabla J(n)$ ).

$$w(n+1) = w(n) + \frac{1}{2} \mu [-\nabla J(n)] \quad (1)$$

In the Equation 1 above,  $w(n)$  corresponds to the filter weighting at a given point in time. The constant  $\mu$  is referred to as step-size. The step-size must be carefully chosen to improve algorithm performance. [1]

### V. SIMULATED ANNEALING ALGORITHM

#### A. Introduction

Simulated annealing (SA) algorithm is an optimization technique based on the way in which a metal cools and freezes into a minimum energy crystalline structure (the annealing process). Simulated annealing algorithm was developed in 1983 to deal with highly nonlinear problems [3].

#### B. Algorithm Operation

SA algorithm approaches optimization problems in an analogous manner to a bouncing ball approach (a ball bouncing over mountains (function crests) and from valley (function troughs) to valley). It begins at a high "temperature" which enables the ball to make very high bounces (enables it to bounce over any mountain to access any valley, given enough bounces). As the temperature declines the ball cannot bounce so high and it can also settle to become trapped in

relatively small ranges of valleys. In the SA algorithm, a generating distribution generates possible valleys or states to be explored. An acceptance distribution is also defined, which depends on the difference between the function value of the present generated valley to be explored and the last saved lowest valley. The acceptance distribution decides probabilistically whether to stay in a new lower valley or to bounce out of it. All the generating and acceptance distributions depend on the temperature. It has been proved that by carefully controlling the rate of cooling of the temperature, SA can easily find the global optimum. [4]

SA's major advantage over other non-gradient based methods (such as Genetic Algorithm, Tabu Search algorithm, Differential Evolution) is an ability to avoid becoming trapped in local minima. The algorithm employs a random search technique, which not only accepts changes that decrease the objective function  $f$  (assuming a minimization problem), but also some changes that increase it. The latter are accepted with a probability  $p = \exp(-df/T)$ , where  $df$  is the increase in  $f$  and  $T$  is a control parameter, which by analogy with the original application is known as the system "temperature".

The following elements must be provided:

- a representation of possible solutions
- a generator of random changes in solutions
- a means of evaluating the problem functions and
- an annealing schedule - an initial temperature and rules for lowering it as the search progresses.

Figure 2 below shows the SA algorithm flowchart [3].

Initially, when the annealing temperature is high, some large increases in  $f$  are accepted and some areas far from the optimum are explored. As execution continues and  $T$  falls, fewer uphill excursions are tolerated (and those that are tolerated are of smaller magnitude).

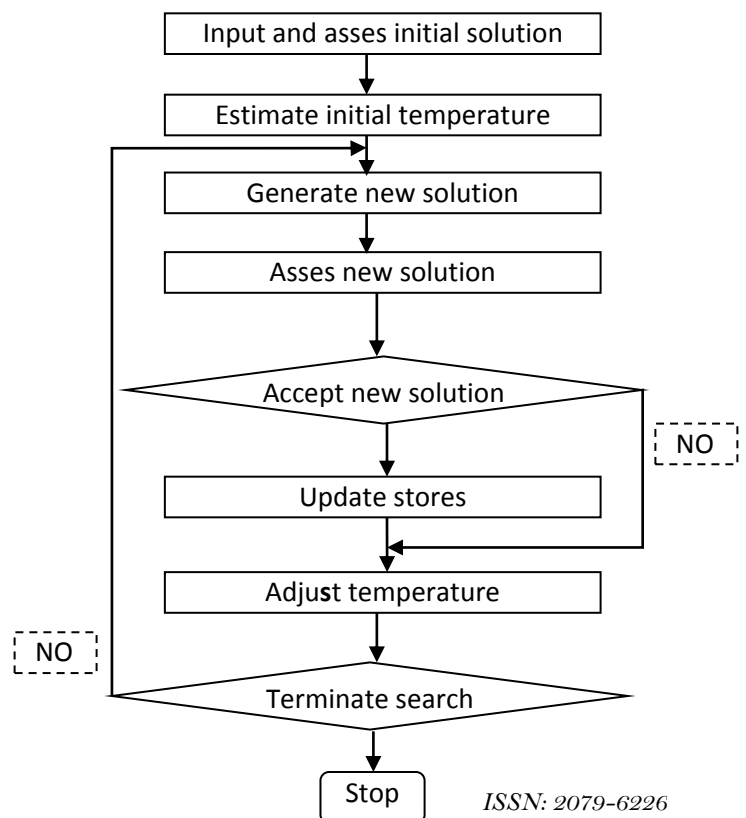

Fig. 2: SA algorithm operation

### C. SA Algorithm Strengths

Simulated annealing can deal with highly nonlinear models, chaotic and noisy data and many constraints. Its main advantages over other local search methods are its flexibility and its ability to approach global optimality. The algorithm is quite versatile and its parameters are easily tuned. Despite having lower convergence rate as compared to other algorithms, the SA algorithm always generates an optimal solution at the end of the day. Upon taking measures to improve the convergence performance of the SA algorithm, it can be a better choice in ANC. This is the subject of the proposed research work.

SA is superior compared to the LMS algorithm in that it doesn't get trapped in local optimal solution. SA algorithm accepts poor solutions with a certain probability figure. This ensures that the algorithm never gets trapped in local solutions.

## VI. METHODOLOGY

The problem at hand is the application of the Simulated Annealing algorithm in adaptive noise cancellation in speech signals.

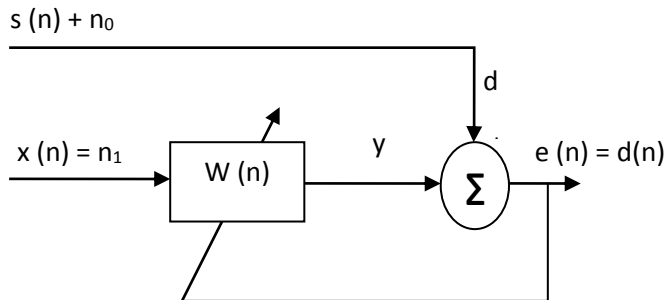

## VII. RESULTS

The signal depicted in Figure 3 was utilized as the desired fetal signal in the first set of simulations. The noise corrupted signal is depicted in Figure 4. The reference signal utilized in the adaptation process is depicted in Figure 5. The reference signal closely resembles the maternal heartbeat signal. The result obtained using the SA algorithm is depicted in Figure 6. The result obtained using the LMS algorithm is depicted in Figure 7.

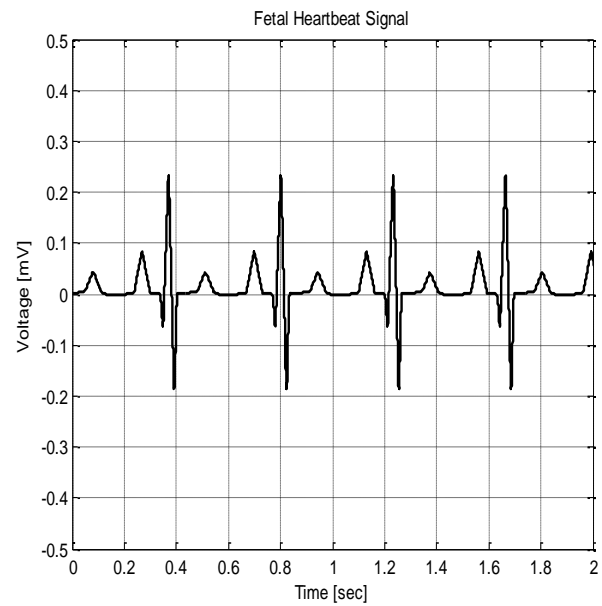

Fig. 3: Desired foetal signal

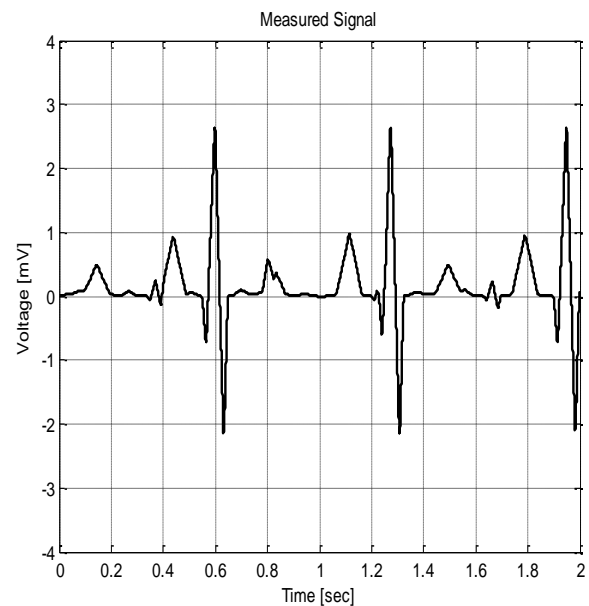

Fig. 4: Corrupted foetal signal

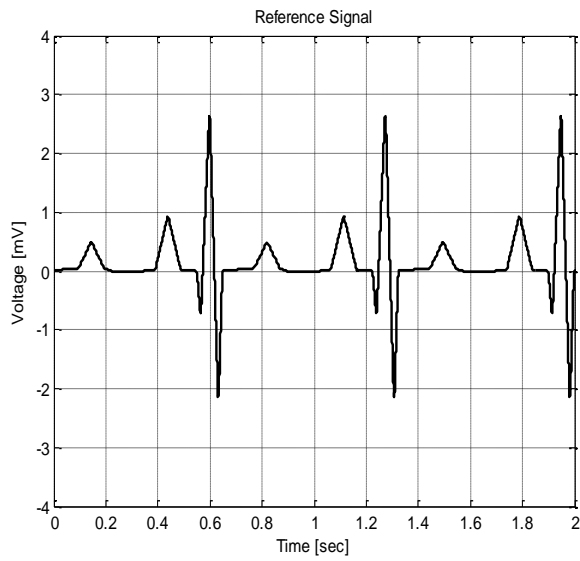

Fig. 5: Reference signal

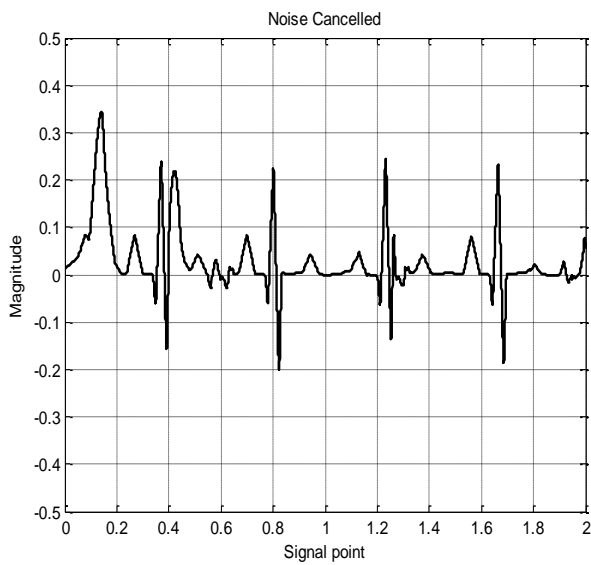

Fig. 6(a): Noise cancellation using SA

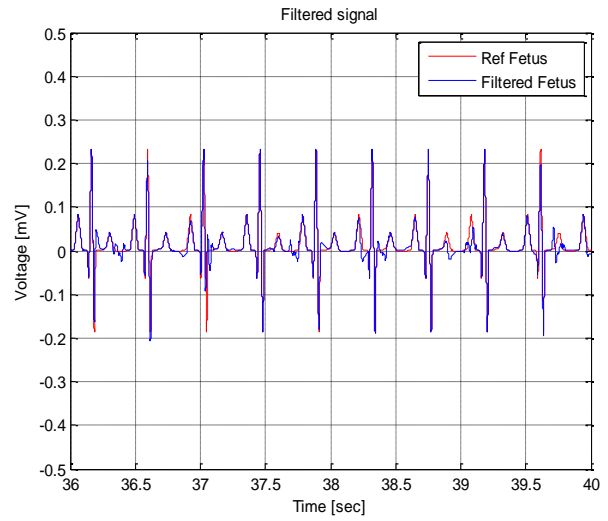

Fig. 6(b): Noise cancellation using SA

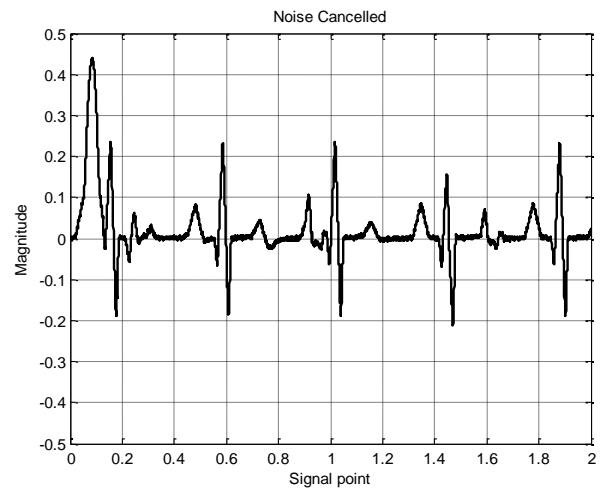

Fig. 7(a): Noise cancellation using LMS

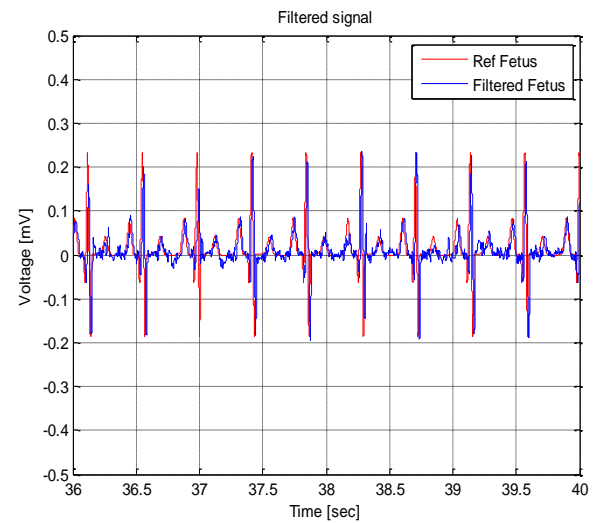

Fig. 7(b): Noise cancellation using LMS

## VIII. DISCUSSION

The SA algorithm is found to generate better results than the LMS algorithm in all simulated scenarios.

Generated signal graphs relay the following information:

- The SA algorithm yields a less noise corrupted signal.
- Irrespective of the waveforms involved, the SA algorithm produces better results.

The SA algorithm yields a noise-cancelled signal output more correlated with the desired signal as compared to the LMS algorithm. The correlation values are 0.967 and 0.923 respectively.

## IX. CONCLUSION

Adaptive noise cancellers play a crucial role in modern communication and sensing devices. The role of efficient adaptation algorithms for use in adaptive noise cancellers cannot be underestimated. Generally the SA algorithm is found to be more efficient than the LMS algorithm in MMSE based adaptive noise cancellation in detecting fetal ECG. As the research into more efficient techniques continues, it would be viable to look into better variants of the SA algorithm.

## BIBLIOGRAPHY

- [1] Simon Haykin, *Adaptive Filter Theory*, 4th ed. Upper Saddle River, New Jersey: Prentice Hall, 2002.
- [2] Stuart D. Albert, *Fundamentals of Adaptive Noise Cancellation*. Fort Monmouth, New Jersey: U. S. Army Laboratory Command, 1991.
- [3] Franco Buseti, "Simulated annealing overview," JP Morgan, Italy, Scholarly article 2005.
- [4] Ernesto Garcia, Lorena Marcela, and Gallegos Araiza, "Simulated Annealing with Previous Solutions Applied to DNA Sequence Alignment," *ISRN Artificial Intelligence*, vol. 2012, pp. 1-7, July 2012.



# Design of Adaptive Noise Canceller in Speech Signals Using Simulated Annealing Algorithm

Kevin Mwongera, Kibet Langat, E. N. Ndung'u

**Abstract-** Adaptive noise cancellation is an active research field. Speech signals in communication networks undergo interference. Adaptive noise cancellation is vital in cancelling out noise in corrupted speech signals. The main objective of adaptive noise cancellation is to estimate the corresponding noise signal and consequently subtract it from the corresponding corrupted signal plus noise signal to obtain the noise free signal. In this paper, use of the simulated annealing algorithm in adaptive noise cancellation in speech signals is studied. A comparison is made between use of the simulated annealing algorithm and the commonly used Least Mean Squares (LMS) algorithm. The simulated annealing algorithm is found to perform better than the LMS algorithm. The entire analysis is made through simulations in MATLAB software.

**Key words-** Adaptive noise cancellation, simulated annealing algorithm, least mean squares algorithm

## I. INTRODUCTION

Contamination of a signal of interest by other undesired signals (noise) is a problem encountered in many applications. In most applications, the desired signal has changing characteristics which requires an update in the filter coefficients for a good performance in signal extraction. Since conventional digital filters with fixed coefficients do not have the ability to update their coefficients, adaptive digital filters are used to cancel the noise.

Adaptive noise cancellation filters have been of immense interest due to their self-reconfiguration properties [1]. When some prior knowledge about the statistics of a signal under consideration is available, an optimal filter for such application can be easily developed (referred to as the Wiener Filter which minimizes the respective Mean Square Error (MSE)). MSE is the difference between the developed optimal filter output and the desired response [1]. If this prior

knowledge is unavailable, adaptive filtering algorithms have the ability to adapt the corresponding filter coefficients to be well-matched with the involved signal statistics.

Adaptive filtering algorithms have been used in many fields such as signal processing, communications systems and control systems [1].

Adaptive filtering process consists of two major steps; the filtering process which generates an output signal (response) from the input signal, and an adaptation process; which adjusts the filter coefficients intelligently in order to result in an optimal output.

## II. ADAPTIVE NOISE CANCELLATION

Adaptive filters are the major component of adaptive noise cancellation schemes. In communication systems, the term filter refers to a system that reshapes the frequency components of an input signal to generate an output signal with desirable features. Basically an ANC would be of the nature illustrated in Figure 1 below. [1], [2].

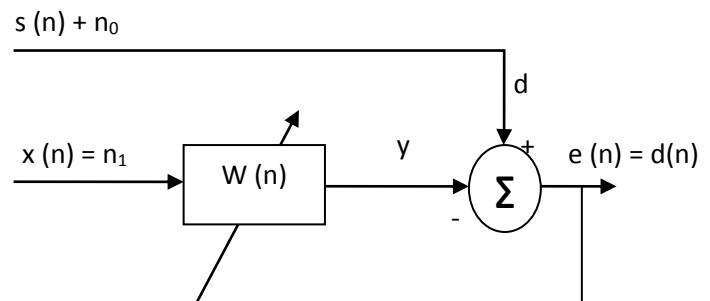

Fig. 1: Adaptive noise canceller

In this configuration, the input  $x(n)$  (a noise source  $n_1(n)$ ), is compared with a signal  $d(n)$ , which consists of a signal  $s(n)$  corrupted by another noise signal  $n_0(n)$ . Input  $x$  is highly correlated with the noise  $n_1$  and lowly correlated with signal  $s$ . The output  $e = (d-y)$  is ideally free of noise  $n$ . The optimal adaptive filter coefficients lead to the error signal being a noiseless version of the signal  $s(n)$ .

Mr. Kevin Mwongera, Department of Telecommunication Engineering, JKUAT. (phone: +254724173870; e-mail: kmwongera@jkuat.ac.ke).

Dr. Kibet Langat, Department of Telecommunication Engineering, JKUAT. (phone: +254724833749; e-mail: kibetlp@jkuat.ac.ke).

Dr. E. N. Ndung'u, Department of Telecommunication Engineering, JKUAT. (phone: +254721366349; e-mail: enndungu@yahoo.com).

### III. ADAPTIVE NOISE CANCELLERS PERFORMANCE MEASURES

#### A. Convergence Rate

The Convergence rate determines the rate at which the filter converges to the corresponding optimal state. Fast convergence rate, whilst ensuring stability, is a desired characteristic of an adaptive system.

#### B. Computational Complexity

Computational complexity is particularly important in real time adaptive filter applications. When a real time system is being implemented, there are hardware limitations that may affect the performance of the system. A highly complex algorithm will require much greater hardware resources than a simplistic algorithm.

#### C. Filter Length

The filter length of an adaptive system is inherently tied to many of the other performance measures. The length of the filter specifies how accurately a given system can be modeled by the adaptive filter, the longer the better. In addition, the filter length affects the convergence rate, by increasing or decreasing computation time/ complexity.

### IV. LEAST MEAN SQUARES ALGORITHM

The LMS minimizes the Mean Square Error function  $J(n) = E \{ |e(n)|^2 \}$  iteratively by updating filter weights in a manner negative to the direction of the gradient of the MSE function ( $-\nabla J(n)$ ).

$$w(n+1) = w(n) + \frac{1}{2} \mu [-\nabla J(n)] \quad (1)$$

In the Equation 1 above,  $w(n)$  corresponds to the filter weighting at a given point in time. The constant  $\mu$  is referred to as step-size. The step-size must be carefully chosen to improve algorithm performance. [1]

### V. SIMULATED ANNEALING ALGORITHM

#### A. Introduction

Simulated annealing (SA) algorithm is an optimization technique based on the way in which a metal cools and freezes into a minimum energy crystalline structure (the annealing process). Simulated annealing algorithm was developed in 1983 to deal with highly nonlinear problems [3].

#### B. Algorithm Operation

SA algorithm approaches optimization problems in an analogous manner to a bouncing ball approach (a ball bouncing over mountains (function crests) and from valley (function troughs) to valley). It begins at a high "temperature" which enables the ball to make very high bounces (enables it to bounce over any mountain to access any valley, given enough bounces). As the temperature declines the ball cannot bounce so high and it can also settle to become trapped in relatively small ranges of valleys. In the SA algorithm, a generating distribution generates possible valleys or states to be explored. An acceptance distribution is also defined, which

depends on the difference between the function value of the present generated valley to be explored and the last saved lowest valley. The acceptance distribution decides probabilistically whether to stay in a new lower valley or to bounce out of it. All the generating and acceptance distributions depend on the temperature. It has been proved that by carefully controlling the rate of cooling of the temperature, SA can easily find the global optimum. [4]

SA's major advantage over other non-gradient based methods (such as Genetic Algorithm, Tabu Search algorithm, Differential Evolution) is an ability to avoid becoming trapped in local minima. The algorithm employs a random search technique, which not only accepts changes that decrease the objective function  $f$  (assuming a minimization problem), but also some changes that increase it. The latter are accepted with a probability  $p = \exp(-df/T)$ , where  $df$  is the increase in  $f$  and  $T$  is a control parameter, which by analogy with the original application is known as the system "temperature".

The following elements must be provided:

- a representation of possible solutions
- a generator of random changes in solutions
- a means of evaluating the problem functions and
- an annealing schedule - an initial temperature and rules for lowering it as the search progresses.

Figure 2 below shows the SA algorithm flowchart [3].

Initially, when the annealing temperature is high, some large increases in  $f$  are accepted and some areas far from the optimum are explored. As execution continues and  $T$  falls, fewer uphill excursions are tolerated (and those that are tolerated are of smaller magnitude).

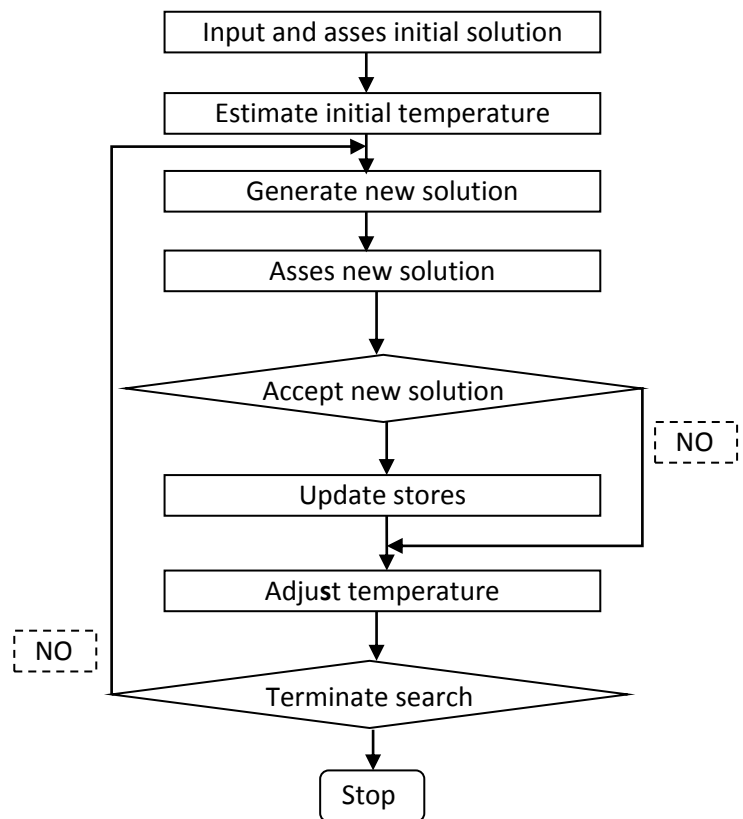

Fig. 2: SA algorithm operation

### C. SA Algorithm Strengths

Simulated annealing can deal with highly nonlinear models, chaotic and noisy data and many constraints. Its main advantages over other local search methods are its flexibility and its ability to approach global optimality. The algorithm is quite versatile and its parameters are easily tuned. Despite having lower convergence rate as compared to other algorithms, the SA algorithm always generates an optimal solution at the end of the day. Upon taking measures to improve the convergence performance of the SA algorithm, it can be a better choice in ANC. This is the subject of the proposed research work.

SA is superior compared to the LMS algorithm in that it doesn't get trapped in local optimal solution. SA algorithm accepts poor solutions with a certain probability figure. This ensures that the algorithm never gets trapped in local solutions.

## VI. METHODOLOGY

The problem at hand is the application of the Simulated Annealing algorithm in adaptive noise cancellation in speech signals.

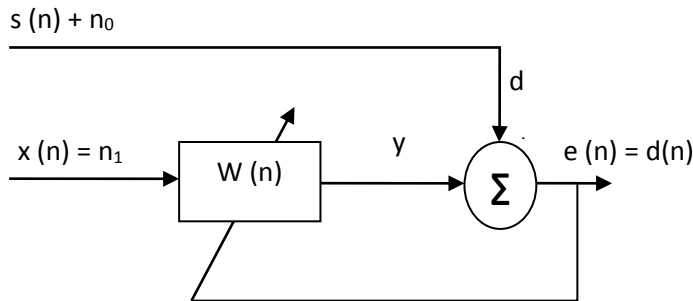

## VII. RESULTS

### A. Signal Set 1

The signal depicted in Figure 3 was utilized as the desired speech signal in the first set of simulations. The noise corrupted signal is depicted in Figure 4. The reference signal utilized in the adaptation process is depicted in Figure 5. The result obtained using the SA algorithm is depicted in Figure 6. The result obtained using the LMS algorithm is depicted in Figure 7.

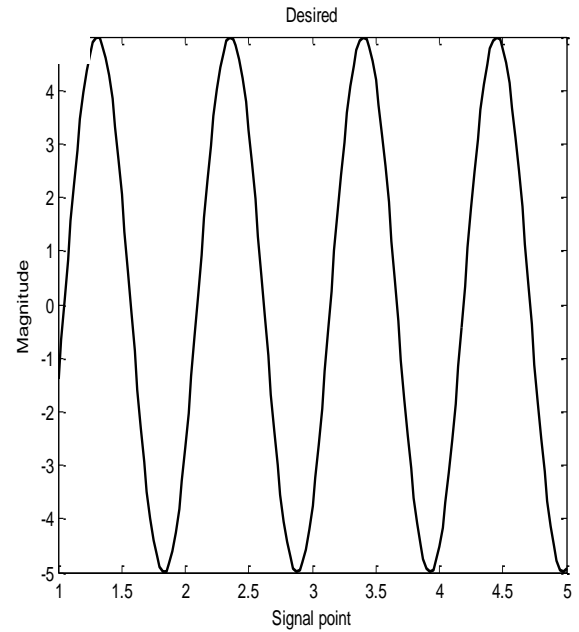

Fig. 3: Desired speech signal

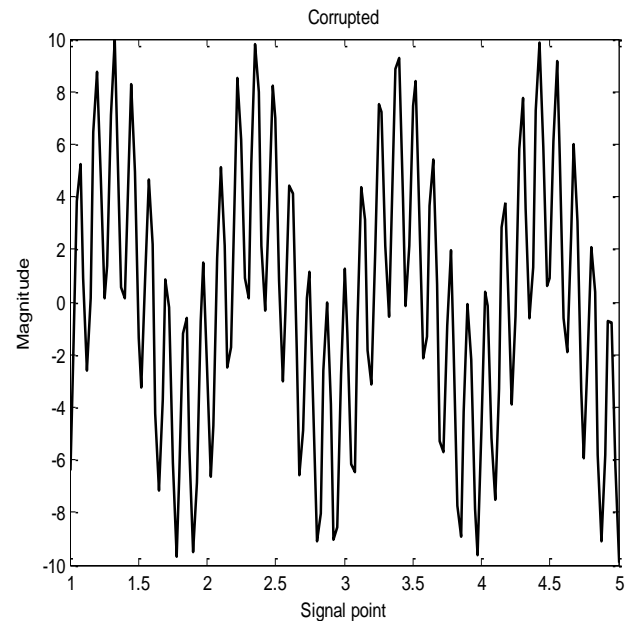

Fig. 4: Corrupted speech signal

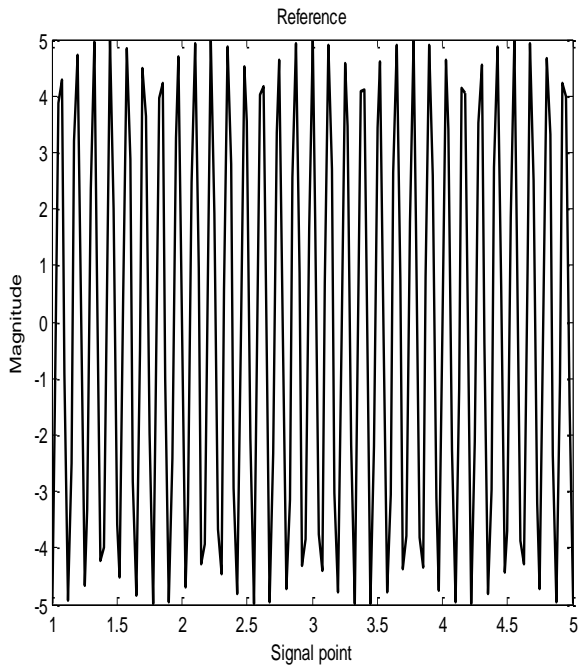

Fig. 5: Reference signal

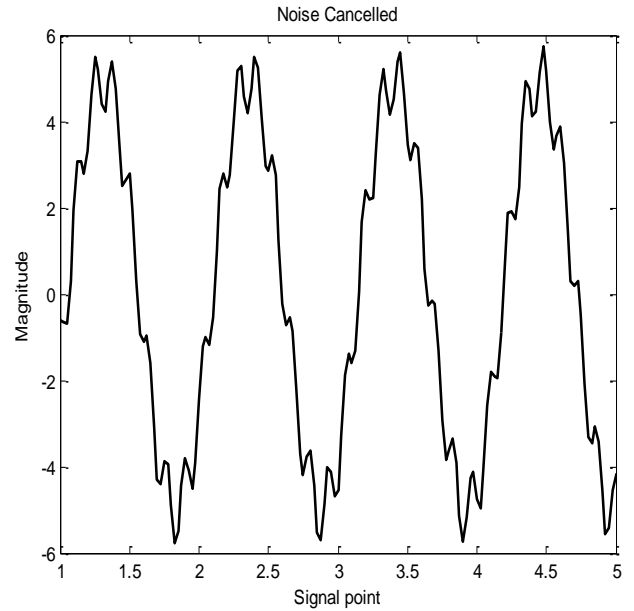

Fig. 7: Noise cancellation using LMS

### B. Signal Set 2

The signal depicted in Figure 8 was utilized as the desired speech signal in the first set of simulations. The noise corrupted signal is depicted in Figure 9. The reference signal utilized in the adaptation process is depicted in Figure 10. The result obtained using the SA algorithm is depicted in Figure 11. The result obtained using the LMS algorithm is depicted in Figure 12.

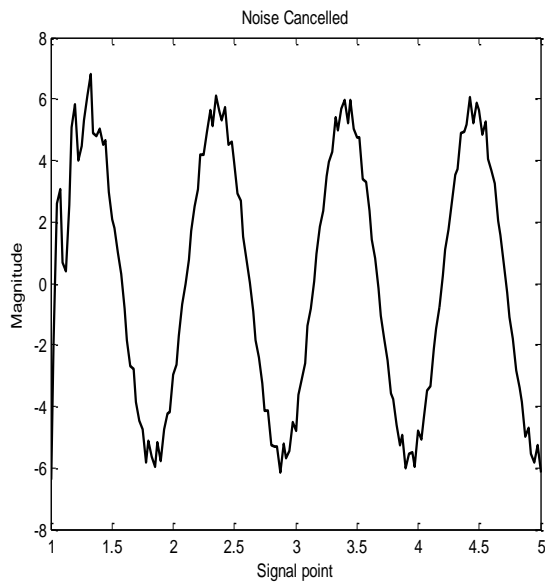

Fig. 6: Noise cancellation using SA

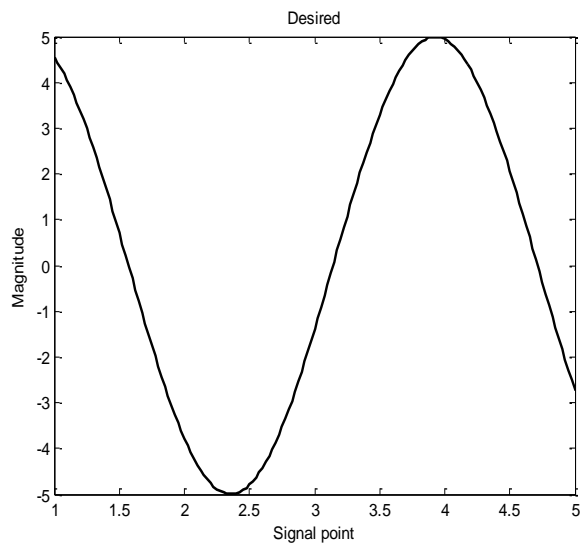

Fig. 8: Desired speech signal

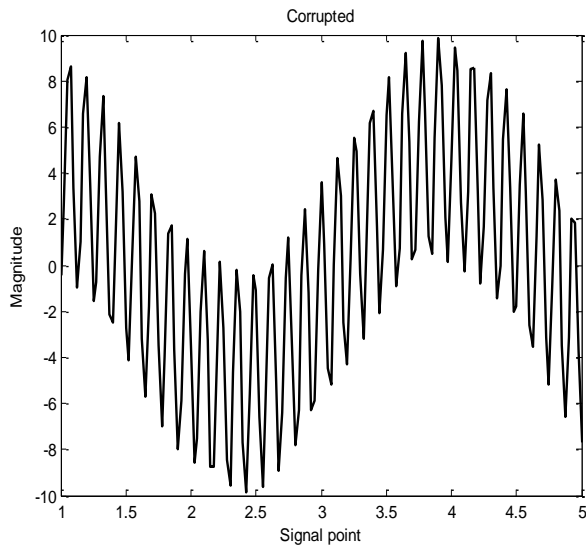

Fig. 9: Corrupted speech signal

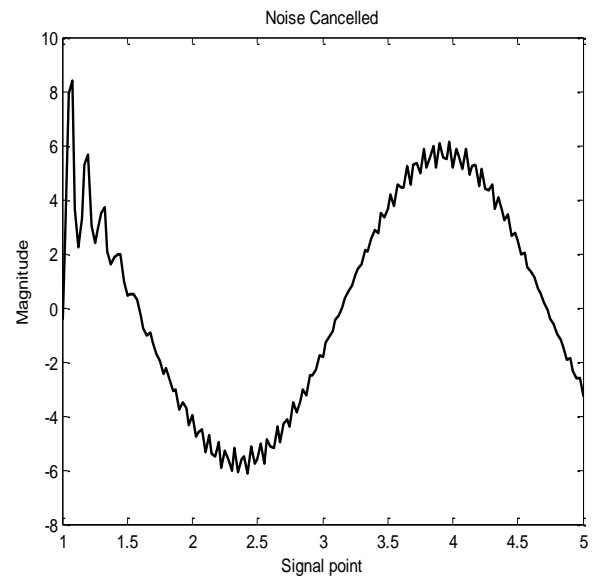

Fig. 11: Noise cancellation using SA

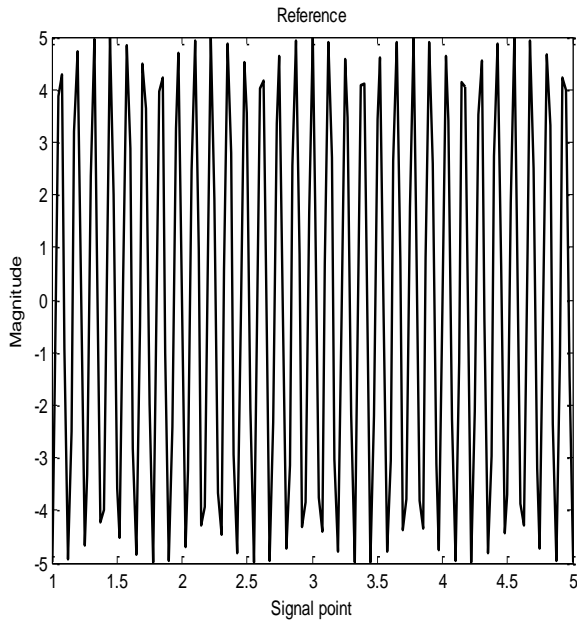

Fig. 10: Reference signal

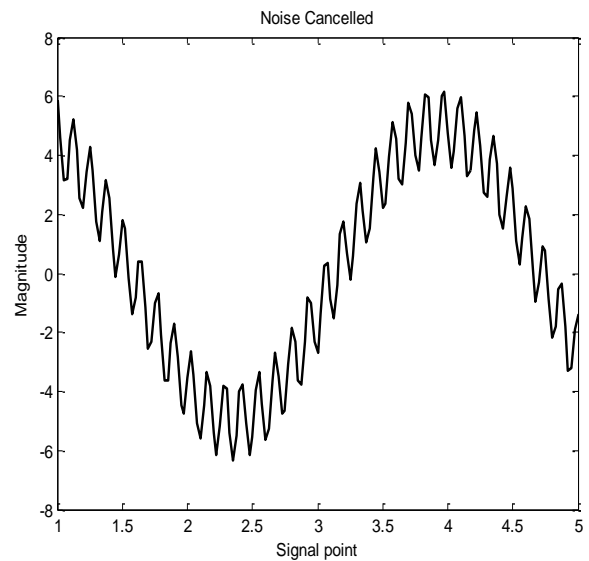

Fig. 12: Noise cancellation using LMS

## VIII. DISCUSSION

The SA algorithm is found to generate better results than the LMS algorithm in all simulated scenarios.

Generated signal graphs relay the following information:

- The SA algorithm yields a less noise corrupted signal.
- Irrespective of the waveforms involved, the SA algorithm produces better results.

The SA algorithm yields a noise-cancelled signal output more correlated with the desired signal as compared to the LMS algorithm.

## IX. CONCLUSION

Adaptive noise cancellers play a crucial role in modern communication networks. The role of efficient adaptation algorithms for use in adaptive noise cancellers cannot be underestimated. Generally the SA algorithm is found to be more efficient than the LMS algorithm in MMSE based adaptive noise cancellation. As the research into more efficient techniques continues, it would be viable to look into better variants of the SA algorithm.

## BIBLIOGRAPHY

- [1] Simon Haykin, *Adaptive Filter Theory*, 4th ed. Upper Saddle River, New Jersey: Prentice Hall, 2002.
- [2] Stuart D. Albert, *Fundamentals of Adaptive Noise Cancellation*. Fort Monmouth, New Jersey: U. S. Army Laboratory Command, 1991.
- [3] Franco Buseti, "Simulated annealing overview," JP Morgan, Italy, Scholarly article 2005.
- [4] Ernesto Garcia, Lorena Marcela, and Gallegos Araiza, "Simulated Annealing with Previous Solutions Applied to DNA Sequence Alignment," *ISRN Artificial Intelligence*, vol. 2012, pp. 1-7, July 2012.

# Development of a Property Tax Information Management System for County Governments: A Case Study of Kapsabet Sub-county

Faith Jeruto Birir and Moses Murimi Ngigi

**Abstract**— Complete and reliable information is important for planning and decision making. Various challenges face Kapsabet sub-county revenue sector in regard to property tax rates and single business permit fee collection and management. The main challenges include lack of full information on the property owners, poor record keeping and the outdated spatial data. There is no link between the location of a property and its corresponding data, rendering all forms of spatial analysis impossible. The main objective of the study was to address this problem by developing a web-based property tax information management system that provides an effective tax collection and management. Open source GIS software was employed to develop the system. The system developed is composed of three sub-components: a database management system, a web-based mapping display and a short message service system. The database is centralized and contains tools for data updating and visualization while the web-based hosts the map visualization. The short message service (SMS) provides information on taxes arrears. Information on land parcels, buildings, building units, land rates and single business permit fees was incorporated in the resulting system. The system has provided an interactive link between real property and office records. The database results are various maps and list of coordinates for the tax defaulters. Maps depicts land use, unregistered properties, taxed and nontaxed properties. List of coordinates enable tracing of tax defaulters through handheld GPS. The SMS has provided a convenient way of reminding the property owners on the payment of taxes through their mobile phones. This system may be used by property owners in the diaspora to access information on their property through the web.

**Keywords**— GIS database, Property tax, Short Message Service, Visualization.

## I. INTRODUCTION

Valuation principles became routine in countries colonized by the English. The same needs for valuation such as Taxation of Land and compulsory acquisition became imminent in the colonies. In East Africa, for instance, the English set up a system of local government in each country and the local authorities had to rely on land taxation as a major source of revenue. In Kenya, Local Government Rating Ordinance was passed in 1928, giving municipal councils power to

F. J. Birir, Department of Geomatic Engineering and Geospatial Information Science, Institute of Geomatics, GIS and Remote Sensing, Dedan Kimathi University of Technology (phone: +2540722462989; e-mail: birir.faith@gmail.com).

M. M. Ngigi, Department of Geomatic Engineering and Geospatial Information Science, Institute of Geomatics, GIS and Remote Sensing, Dedan Kimathi University of Technology (e-mail: murimi99@gmail.com).

tax land. A valuation organization was subsequently set up in the land Department in 1950 to help the local authorities to prepare the valuation rolls, [1].

Property tax was introduced in Kenya as early as 1900, where it was first applied to Mombasa on annual rental value basis [2], [3]. It was introduced in Nairobi, the following year. In 1923, taxation on the basis of annual values was found wanting as too few properties had developed. The site value tax was introduced throughout Kenya in 1928.

Taxation was introduced to the whole nation but the property taxes were bestowed to the local government authority. With the implementation of the new constitution, the county government are charged with the responsibility of making sure the county runs smoothly through the funds raised from different sources. One of the most important sources are the land rates and the single business permit fees from land owners and business community.

Developing countries everywhere are undertaking fiscal decentralization and local government reforms to improve economic efficiency and accountability. These reforms involve rationalizing expenditure and revenue responsibilities along with establishing intergovernmental transfer programs to enable governments to better fulfil their stabilization, distribution, and allocation functions [4] and [5].

One critical prerequisite for sustainable local government reform is adequate financial resources. Thus, in addition to supplementing local resources through establishing central local revenue transfers, governments are searching for ways to mobilize and improve existing local own-source revenue sources. Virtually all countries seem to be focusing on strengthening the property tax, the most common revenue source for local governments throughout the world [6].

Property taxation plays a major role in financing local governments throughout the world. Property taxes account for 40-80 percent of local government finance, 2-4 percent of total government taxes and about 0.5-3.0 percent of Gross Domestic Product (GDP) [7]. In contrast to developed countries, developing countries tend to generate significantly less property taxes revenue, with property taxes typically generating a maximum of 40percent of local government revenue, 2 percent of total government revenue, and about 0.5 percent of GDP [8].

Kenya is a clear example of a developing country underutilizing its property tax capacity. Property taxes (known in Kenya as rates) provide an average of 22 percent of total recurrent revenues for local authorities and represent 1.3 percent of total government tax revenue and 0.3 percent of GDP [9]. The property rates in 1994-95 provided K£ 60.2 Million and K£ 5.1 Million to the municipal councils and to town, urban and county councils, respectively [10]. In another study, it was found that property tax is the single most important source of revenue for local authorities in Kenya [11]. This source of revenue has been said to be the most lucrative and promising [11]. Property tax in Kenya, according to [10] is the least tapped source of tax

revenue to support urban governments in Africa. These local governments are the most affected by rapid urban growth, unplanned in many countries. The extent to which local government has control and has an understanding of these taxes is an important determinant of its commitment to ensure proper administration in collection and enforcement is ensured.

Property taxes are the major source of revenue that allow County and Sub-county governments to provide community services such as firefighting services, lights along the street, cleanliness of town, sewerage, supply of clean water, recreational facilities, health facilities, schools and infrastructure services. This revenue is not tapped efficiently due to the current situation of poor record keeping and corruption. In Kapsabet Sub-County government, the record books are frayed and some information is missing. The records also do not have enough data like the telephone numbers of the land owners or email and therefore tracing them is a problem.

#### **Types of Property Rates**

**Land Rate:** This is the tax levied on land based on the market value of land. Value of land increases as it is serviced with good roads, water, sewage system, street lights and other security systems. Once serviced the land is considered usable as zoned for settlements, industrial or agriculture.

**Real Estate Rate** (Land plus Immovable Object on the land): When a building that is immovable is added to a piece of land, this property is referred to as real estate. The property value increases based on the addition made. A property tax is thus assessed based on Land and Building combined as one.

**Personal Property:** These are movable objects. This mainly applies to privately held vehicles (Cars, Lorries, Trucks and others) and mobile machinery that are owned by residents of a County.

#### **Sources of revenue**

**Single business permit-** for registered business and operation license fee. This fee is paid to the sub county annually for respective businesses to run.

**Property rates-** these are land rates and land rent charged on land only. Within the former municipal boundaries of the Kapsabet sub county, land rates are charged while land rents are charged mostly outside the former municipality. Land rents are charged on land where the sub county has leased to the residents.

**Housing and stall rents-** these are revenue from rented houses and stalls from the former municipal council.

**Accountable documents management-** Receipt books for parking fee and market fee as well as the motorcycle fees.

**Customer services and billing-** bills arising from other activities and charges like vehicle obstruction, violation of laws, etc.

Other sources of revenue are: administrative services fees for advertisement of various documents such as part development plan, auctioneering, etc., Building fees for architectural approval fee, special approval fee, special development application fee and structural plans and cesses- animal cess, timber cess, skin and hides cess and tea cess. Public health facilities, educational related revenues such as registration of public and private schools, technical services fee such as blue prints, banners, building inspection and certificate of compliance, sewerage administration, and slaughterhouse administration fee, sale of sub county assets and social premise use charges such as hiring of social hall, etc are also sources of revenue. The study area is the Kapsabet Sub County (former Kapsabet municipality).

## **II. METHODOLOGY**

The approach taken to achieve the set objectives involved several steps: data collection, data processing, database design, loading database to the web, development of SMS service and system

implementation. The first step was to collect relevant data from Survey of Kenya, field observation; and Kapsabet sub county office, provided information such as land rates, dates of payment, etc.,. Ground observation was done to verify the office records. The data was then converted to the desired formats. The spatial data was linked to respective non spatial data. To process the data, Quantum GIS software was used. Database design was done in Dia software using entity relation diagram (ERD) and was implemented in Quantum GIS and PostgreSQL. The database was published to the web using an Open Source server called GeoServer. The SMS service was developed through java code and an internet modem as the gateway as in Fig1.

Several Open Source tools and technologies were used to develop the system. Quantum GIS was for data processing and digital map creation. GeoServer was used to publish the geospatial data to the web through Open Layers. Java scripts were used to connect to the database and an internet modem as the gateway for the SMS service to reach the intended destiny.

Two types of data were collected namely the attribute and spatial data. The spatial data were the Registry Index Maps (RIMs) of fixed boundaries which was obtained from Survey of Kenya and the Quick Bird satellite image obtained from Survey of Kenya of February 2014. The attribute data was obtained from Kapsabet Sub County revenue office. These data was not adequate as the sub county staff could not release the actual data for individual tax payment for this study. Dummy data was used for ownership, land rate, single business permit fee, dates of payment and actual payments. Ground observations was done on land use, building use, number of floors of the building and unit use. The ground observation information formed the attribute data.



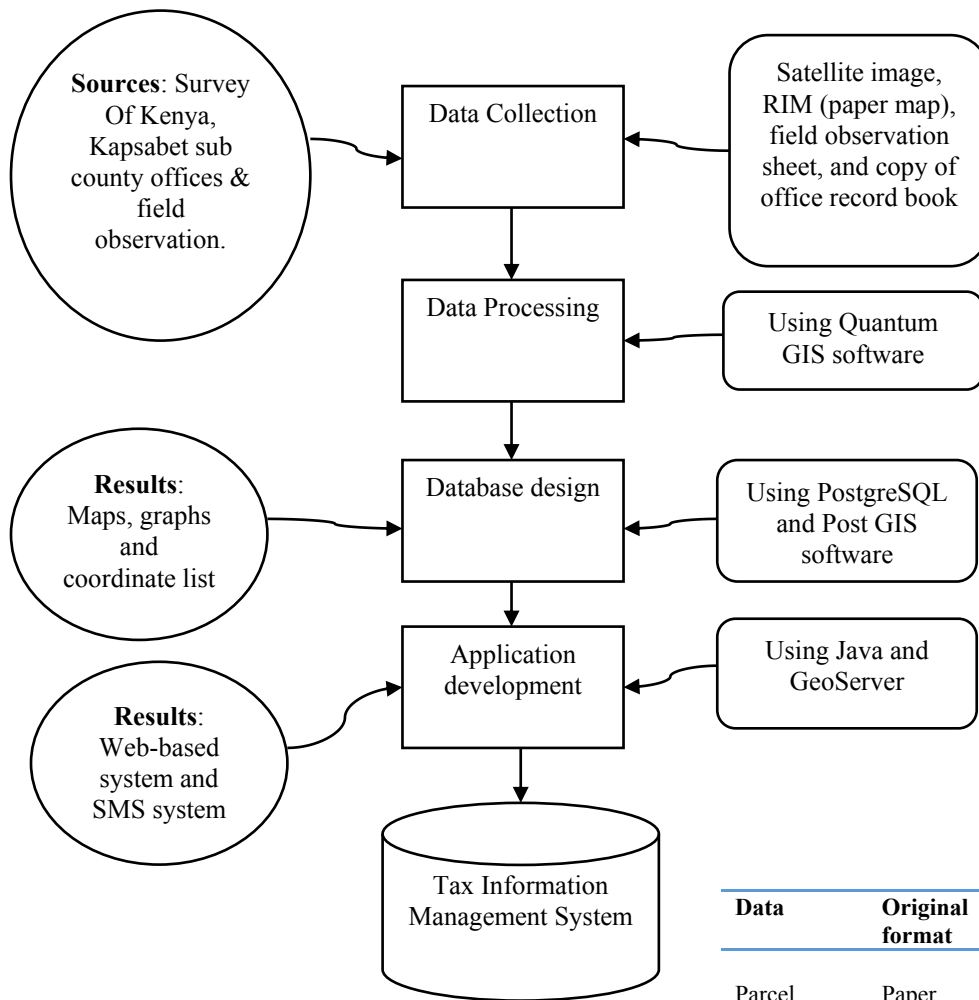

Fig 1: Flowchart for the system implementation.

### III. DATA PROCESSING AND ANALYSIS

The data used in the study was in different formats depending on source and type. All the data used to develop the system is summarized in Table 1.

Data	Original format	Process	Final format	Source
Parcel	Paper Map (RIM)	Scanned, georeferenced, digitized	shape file	Survey of Kenya
Roads and Buildings	Image/raster (Quick Bird)	Digitize roads and Buildings	Shape file	Survey of Kenya
Building units	Image/raster (Quick Bird)	Digitize	Shape file	Survey of Kenya
Parcel, building and building unit information	Paper	Digitize	Parcel, building and building unit information	Field observation and sub county

Table 1: Data, process and source

Scanning is the process of converting analogue data to digital raster model. RIM sheet 1 of Kapsabet Township was scanned at a resolution of 400dpi and colour. The scanned RIM was georeferenced that is aligning geographic data to a known coordinate system so it can be viewed, queried, and analysed with other geographic data. It may involve shifting, rotating, scaling, skewing, and in some cases warping, rubber sheeting, or orthorectifying the data. Four control points were used to georeference the scanned RIM in QGIS software environment. The four control points were obtained from field observation of the actual location of beacons. The coordinates system used the Universal Transverse Mercator projection (UTM) and the datum was Arc 1960.

Satellite image was in soft copy and geo-referenced in UTM coordinates with Arc 1960 as the datum. Layer of parcels was created as shape file and the above projections information were input. Buildings, units and road layers were created too on QGIS environment.

The process of converting the geographic features on a satellite image and RIM onto vector format in the computer was done in QGIS environment. This process is called on screen digitization. It converted raster data model into vector data model.

The layers created and digitized were parcels, buildings, roads and building units. Parcels and buildings were digitized as polygons. Roads were digitized as polylines while building units were digitized as points. The attribute fields' of the layers implemented results of the entity relation diagram. One of the attribute field for parcel layer was parcel identification number. Parcel identification number was composed of two parts. Part one is the township number, while the second part is parcel number.

Building layer had attribute field for parcel identification number and for the building number. Building units' purpose was verified through field observation. Its attribute field contained the building unit number and building number.

**A. Topology building and editing.**

This is where checks were carried out to ensure that relevant information required was free from errors. Topology checker is the operation done to display the relationships between connecting and adjacent features in a certain layer such as parcels. These are arcs, polygons and points. It is used for spatial modelling operations that do not require coordinate information. Topology checker in vector main menu is used. Building topology accomplishes the following; merge coordinates within the tolerance of each other, create a list of arcs that define each polygon boundary, numbers the nodes, deletes dangling arcs that are shorter than the specified dangle length. It also builds a polygon attribute table depending on the option used.

**B. Designing of database in PostgreSQL**

In PostgreSQL, the database was created first by connecting to the localhost server and creating new database. The Postgres user password was entered to connect to the server. The database management system was created. A command was run through SQL to enable database with Post GIS extensions. The command was CREATE EXTENSION postgis, it was typed and executed. The attribute fields were created after the normalization process in relational database management system as in Fig 2 and Fig3.

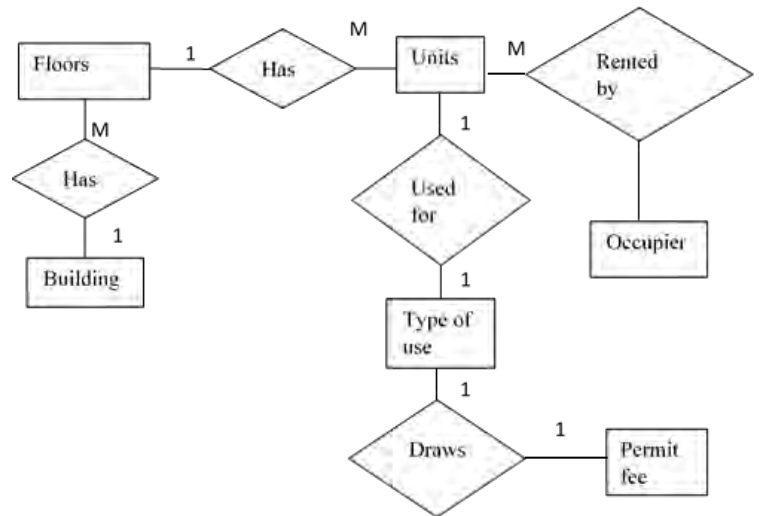

Fig 2: Entity Relational Model for building

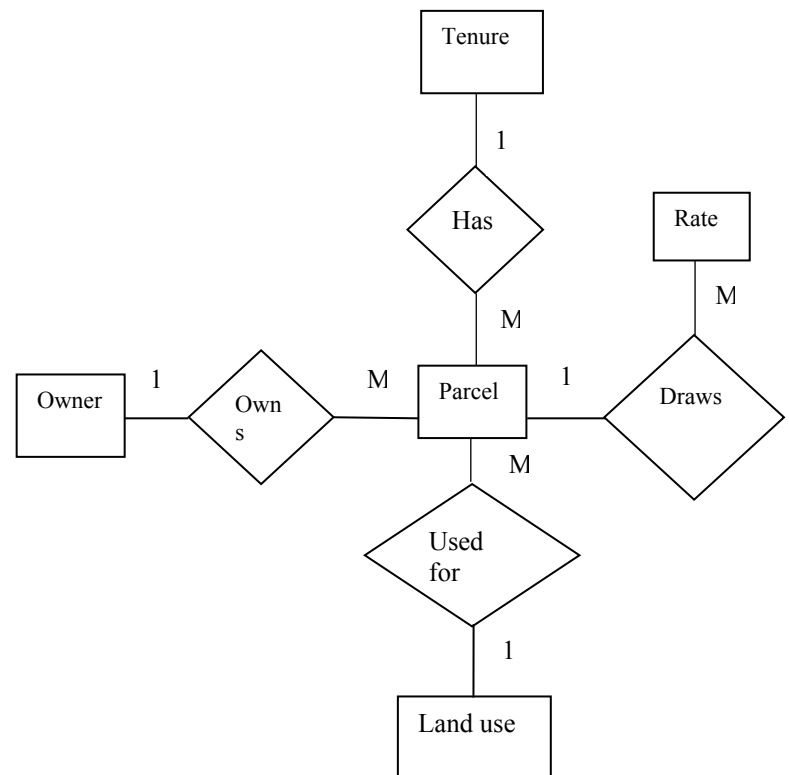

Fig 3: Entity Relational Model for parcel

The datasets captured in QGIS software were imported to PostgreSQL to create tables using Plugins “Post GIS Shape file and DBF loader 2.1.” The Post GIS shape file and DBF loader 2.1 was used to import shape files created in QGIS environment. Tables created were units, building, parcel and spatial reference system. Each table had geometry field and more fields were added and data typed.

**C. Importing PostgreSQL database data into QGIS software**

The data that was entered into the database, was exported onto QGIS application using Post GIS Shape file Import/Export Manager tool.

Post GIS connections was done and the shape file was added and imported to QGIS environment.

#### D. Publishing map layers in the Web

GeoServer is an open source server for sharing geospatial data. Designed for interoperability, it publishes data from any major spatial data source using open standards. The GeoServer was started. Mozilla was started and the URL <http://localhost:8080/geoserver/web/> was copied to Mozilla new page. The username and password were entered as “ admin” and “geoserver” respectively. The workspace was created in GeoServer as the first to loading and publishing data. A workspace (sometimes referred to as a namespace) is the name for a notional container for grouping similar data together. It is designed to be a separate, isolated space relating to a certain project. This workspace was where the map layers were stored once they were imported from the QGIS geodatabase. The next step was to create store. A store is the name for a container of geographic data. A store refers to a specific data source, be it a shapefile, database, or any other data source that GeoServer supports. The layer was loaded into the store. A layer is a collection of geospatial features or a coverage. Typically a layer contains one type of data (points, lines, polygons, raster) and has a single identifiable subject (streets, houses, country boundaries, etc.). A layer corresponds to a table or view from a database, or an individual file. GeoServer stores information associated with a layer, such as projection information and bounding box that is the extend of data. Finally a layer group was created. A layer group makes it possible to request multiple layers with a single WMS request. The map layers were displayed by Open Layer platform.

#### E. Creating Short Message Service (SMS)

The creation of SMS service was categorized into several steps. The template for GSM modem in form of files were downloaded and installed to relevant directories in the computer. Modem drivers were ran to install the modem and the modem port number checked and used in the NetBeans environment. Java codes were generated to connect the Modem, PostgreSQL database, interface and message and also to send the message.

#### Placing files in correct directory

SMSLib files were downloaded from the <http://smslib.org/download>. They were placed in three different folders (lib, lib\_ext, and bin). The files in these folders were copied into their respective folders in Java folder in the computer. The Java comm extension was downloaded from <http://java.sun.com/products/javacomm/> and installed to the computer. The following files were part of this installation:

- File comm.jar was installed to JDKDIR/jre/lib/ext/
- File javax.comm.properties was installed to JDKDIR/jre/lib/
- Library files was installed to JDKDIR/jre/bin/

RxTx is a native library for serial and parallel communication in Java. It is found in pre-build files in the <http://smslib.org/download> site. It provides a portable implementation of Sun's JavaCOMM. File RXTX comm.jar was downloaded and installed to JDKDIR/jre/lib/ext/ while library file was downloaded and installed to JDKDIR/jre/bin/ in the computer.

#### Connecting the database

Connecting to the database in postgresQL was done in Java Neatbeans environment. The package was named survey\_sms\_project. Classes were created and used as following:

- DBsql class was created to connect to the database in PostgreSQL. Columns of the tables in the database were specified as the owner, rate, arrears and mobile phone

number. The interface to display data from the database was created using Pallete Pane. From the interface, SMSlib class was linked.

- SMSlib (message) class was created to send SMS. This was possible when it was linked from the interface.

In Java Neatbeans environment, methods and classes were used. Some of the methods used were: Connect which established connection to the database, input which inserts parcel and building units details into the database, and sendmessage which links the mobile phone number and message and send the message to tax defaulter.

## IV. RESULTS

### Property Tax Information System

The property tax information system is the system that is able to perform GIS queries and analysis on the spatial database that was created using QGIS, PostgreSQL and Post GIS softwares. The system shows the taxed and untaxed properties as in Fig 4 and Fig 5.

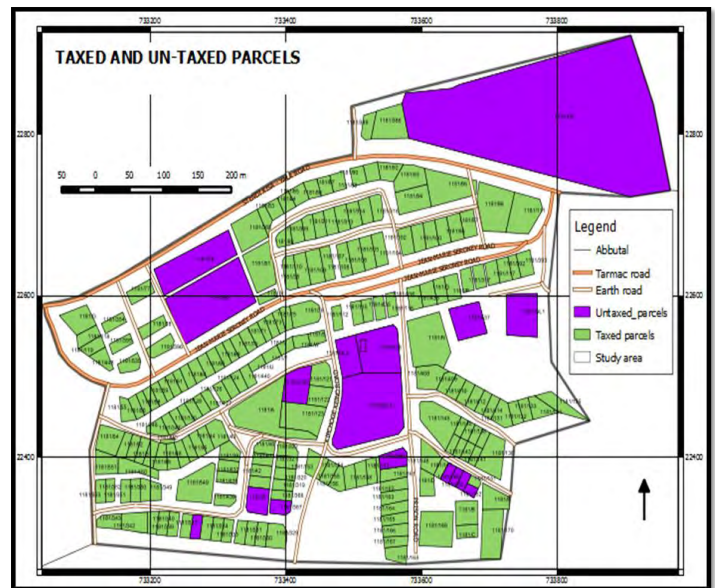

Fig 4: Taxed and untaxed parcels

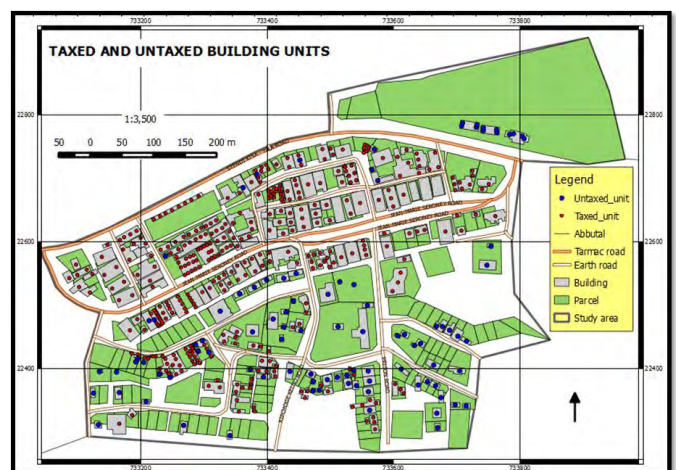

Fig 5: Taxed and untaxed building units

The system facilitates display of properties that have not been registered. Properties are not appearing in the Sub County records as in Fig 6.

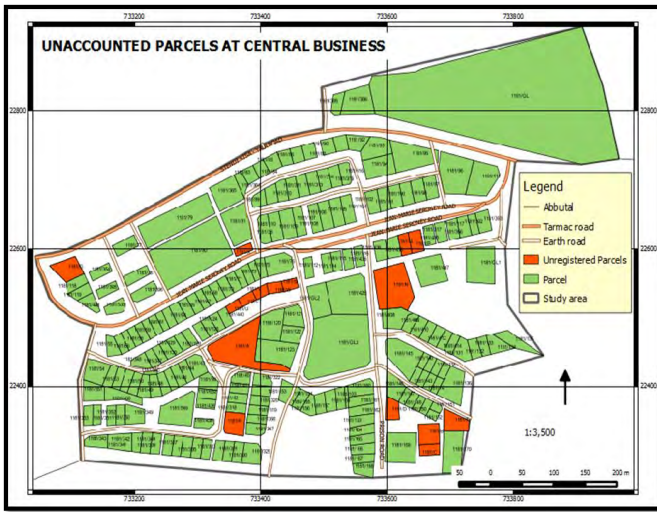

Fig 6: Unregistered parcels

The database facilitated easy identification of the spatial location of tax defaulters and non-tax defaulters as in Fig 7 and Fig 8. The tax collectors can use the spatial location to physically locate the tax defaulter. It will also enable them to easily know how much the tax defaulter owe the sub county.

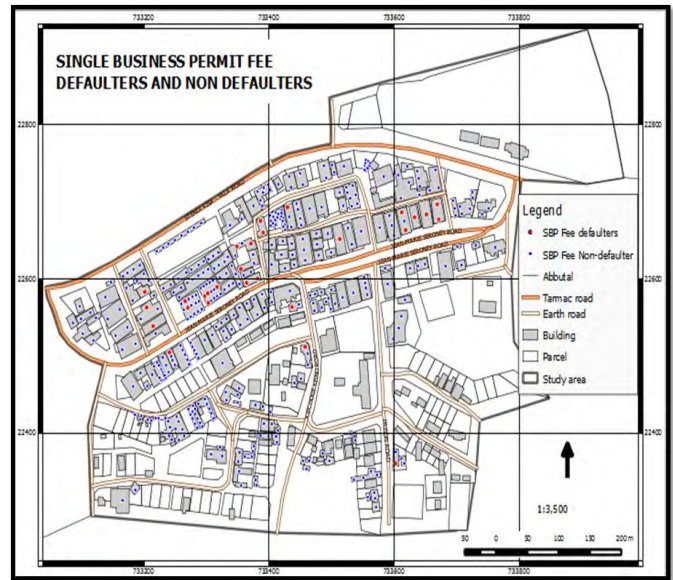

Fig 8: Single business permit fee defaulters and non defaulters

It was also easy for the sub county officials to generate list of owners as well as location of tax defaulters for the Single business permit fee and the land rates from the system. From the centroid of the parcels belonging to tax defaulters, the coordinate list was generated as in Fig 9.

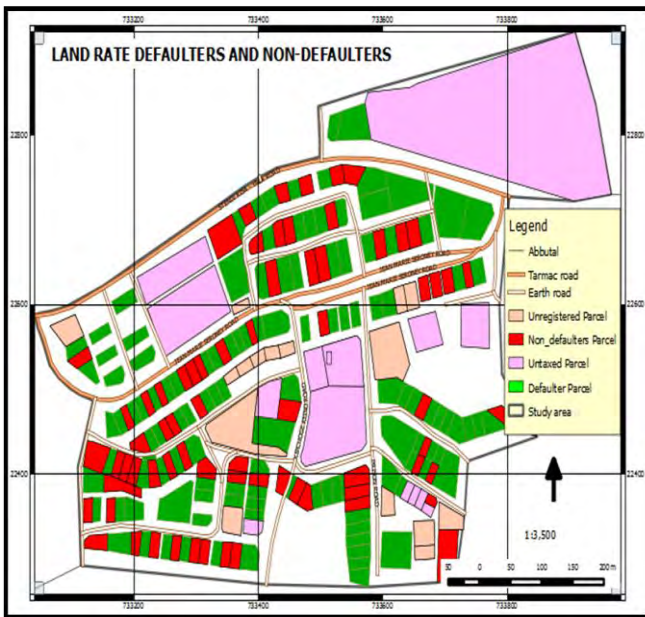

Fig 7: Land rate defaulters and non-defaulters

Coordinates of the single business fee defaulters						
	fname	Iname	Phone_no	arrears	POINT_X	POINT_Y
1						
2	Stephen	Koech	712545232	4000	733371.15	22644.19
3						
4	Stephen	Koech	0712545232	2000	733348.00	22640.55
5						
6						
7	Peter	Maiyo	0712459877	2000	733355.56	22611.13
8						
9	Rachael	Serem	0775621111	2000	733364.00	22593.19
10						
11	Rachael	Serem	0775621111	2000	733381.71	22598.80
12						
13	Richard	Barno	0735237489	1000	733386.00	22673.62
14						
15	Richard	Barno	0735237489	3000	733390.35	22658.49
16						
17	Kelvin	Terer	0721006598	2000	733429.19	22691.27
18						
19	Mark	Misoi	0720852951	3000	733671.81	22675.51
20						
21	Mark	Misoi	0720852951	3000	733669.00	22695.12
22						
23	Benard	Chepkwony	0720714563	4000	733652.00	22681.95
24						
25	Francis	Maneno	0722145263	2000	733633.00	22678.31

Fig 9: Coordinate list of tax defaulters

From the system, it was easy or possible to generate land have been used at Kapsabet Central Business District as in Fig 10.

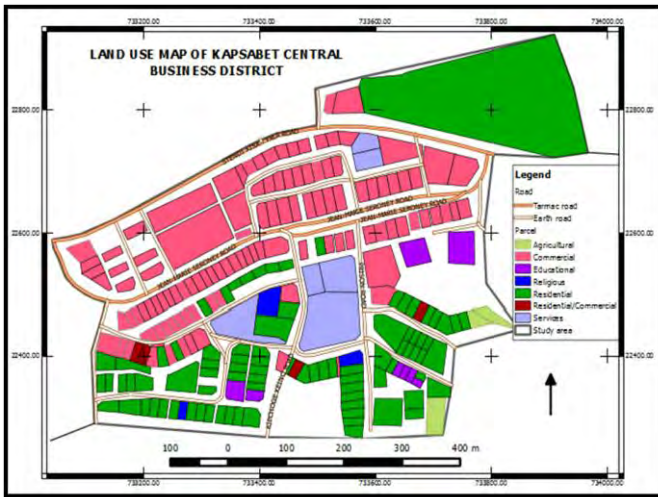

Fig 10: Land use map of Kapsabet Central Business District

At the central business district, there are mainly commercial parcels while residential parcels are away from the central business district. Single business permit fee characteristics, was easily generated from the database. These characteristics will enable the sub county officials to identify the business that generates revenue as in Fig 11.

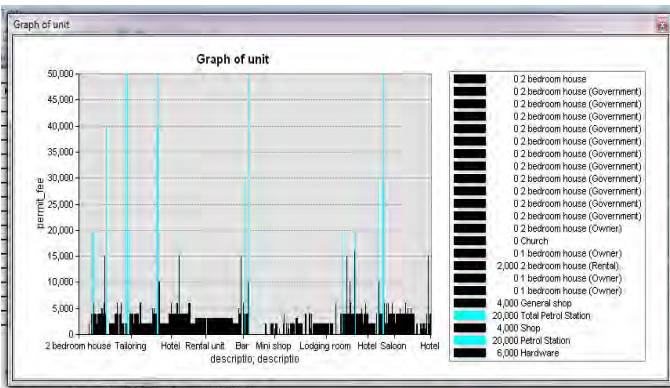

Fig 11: Single business permit characteristics

**Publishing map layers in the web**

Map layers were loaded and published to the web through GeoServer 2.3.0. Mozilla new page was connected to the GeoServer through GeoServer URL. The map layers are loaded to a workspace created in GeoServer. The map layers are from QGIS database. The map layers could be grouped or displayed as one layer. The map layer such as parcel is displayed in the web in the layer preview. The spatial data was displayed as well as the attribute data as in Fig 12.

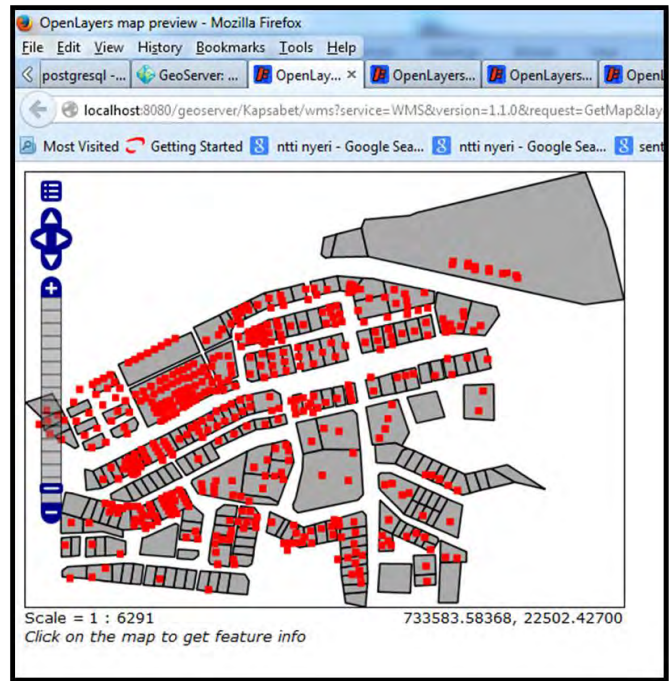

Fig 12: Parcels and building units displayed in the web

**SMS service System**

SMS service system was developed in Java NetBeans IDE 6.7. SMS service system is the system that enables the link of database management system and the message and send information on tax arrears through an internet modem as the gateway. Java scripts were used to connect the system with the PostgreSQL database and to create interface that links the database and message. The system can send messages to several category of tax defaulters. The system picks each individual arrears amount and the mobile phone and sends the message to each one as in Fig13. This provides an easy way of reaching many tax defaulters at once. The system can also send message to one tax defaulter by checking on the send column.

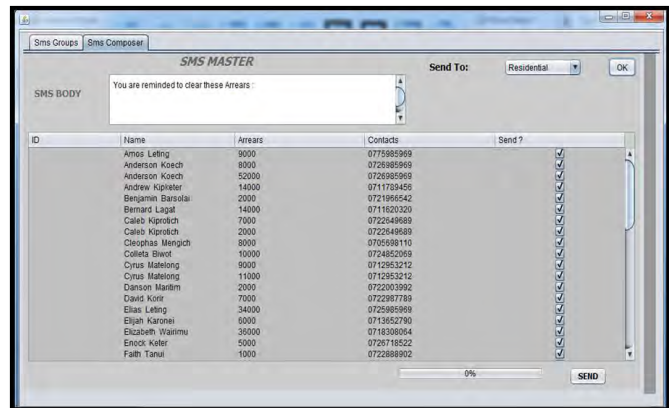

Fig 13: SMS service system linked to database and message

**V. CONCLUSION**

The designed Property Tax Information System will address the needs of Kapsabet sub county revenue officials. One of the most important need for the officials was mapping of the taxed and non-taxed properties within their area of jurisdiction. This will help the Kapsabet sub county officials to quantify taxed and untaxed

properties and locate. The system will enable categorization of properties depending on the proximity according to the number of staff, hence inspection of tax properties becomes manageable. The officials will be able to identify the unaccounted/ unregistered properties and so serves as a check on updating of transacted properties due to subdivisions of land parcels and erection of buildings. The updating of property is made easy in the system. The research found out that there are sixteen parcels which were not registered in the registry index maps as well as in the tax books in the Kapsabet Sub County. Few businesses are running without the single business permit license, implying that taxes from businesses are mostly tapped.

The developed system will also enable the sub county staff to identify land use and institute laws and regulations on development of the area. Land use enables the concern bodies to plan and implement laws and regulations to ensure that there is environmental sustainability in the area of jurisdictions.

The tax information system has provided an interactive link between real property and office records and can facilitate tracking of the property owners through use of handheld GPS. Geographical Information Systems have proven to be power tools in the collection of taxes (land rates and single business permit fee) and tracking delinquent tax payers thus assisting in raising the revenue collection. This is shown by locating the tax defaulters where they are geographically located in the system and also by being able to reach the parcel owners effectively and efficiently through the use of handheld GPS and coordinate list and also sending SMS through the SMS service system. The SMS system retrieves tax arrears information and mobile phones of the tax defaulters from the central database, composes the message and sends to the tax defaulter's mobile phone through an internet modem as a gateway. The SMS is the most convenient and quick way of reaching the tax defaulters. The SMS saves time and resources wastage in spatially locating the tax defaulter and it is not limited by distance. The message received by the tax defaulter in the memory chip is permanently there unless deleted.

Kapsabet residents in the diaspora and local will be able to check on their property tax information in the web. The properties displayed in the web have their attributes that is in the database which is convenient for the property owners. They will also receive messages in their mobile phones to remind them on the payment of property taxes.

The implementation of this system, will aid in efficiently and effectively reach the parcel owners with real time issues and information. It will also aid the Sub County workers to efficiently and effectively perform their duties. It will enable the County officials to ascertain environmental sustainability in the county by making sure land is used as required.

## VI. RECOMMENDATION

The research study was limited to land rates and single business permit fee. In county and sub county governments, there are many sources of revenue which may not have been focused in the research study. There is therefore a great need for further research in the area of property taxes sources in the county and sub county government with emphasis on how emerging technologies can be used to address management of property taxes.

The Property Tax Information Management System development should be taken into considerations by the county government to enable Sub County and the whole County of Nandi collect almost all revenues. This will boost the revenue level in order for the Kapsabet Sub County government and entire County be able to meet the

demands of the people by providing the social amenities required in the county.

## ACKNOWLEDGEMENT

This work was supported by Dr. Moses Murimi Ngigi, Department of Geomatic Engineering and Geospatial Information Science, who supervised and provided helpful comments throughout the project. Survey of Kenya and Kapsabet Sub County institutions are also highly appreciated for provision of satellite image, Registry Index Map and attribute data.

## REFERENCES

- [1] P.M Syagga, "Real Property Valuation in the Year 2000 and Beyond". Proceedings of the Institution of Surveyors of Kenya Seminar 10th December, Mount Kenya Safari Club, Nairobi, 1999.
- [2] W.H.A. Olima, Land Value Taxation in Kenya in McChuskey W.J. and R.C.D Franzsen (eds), Land Value Taxation and Applied Analysis; Ashgate Publishing Ltd England. African Journal of Science and Technology. : VLIR, 2005.
- [3] W.H.A Olima and P.M. Syagga, "Rating System in Kenya: Evolution, Constraints and Potentials", Real Estate Studies Unit - Journal of Property Tax Assessment and Administration. An International Journal for Research in Property Tax. Vol. 2, No. 1, 1996.
- [4] J. Hopkins, the analysis of household surveys: A micro econometric approach to development policy, 1997.
- [5] T.T. Minassian, Decentralizing government operations can improve economic welfare. But decentralization requires close policy coordination among all levels of governments, 1997.
- [6] W. Dillinger, "Urban Property Tax Reform: Guidelines and Recommendations". The World Bank: Urban Management Program. Washington, DC, 1993.
- [7] Youngman and Malme, Land Value Taxation and Development Activity: The Reaction of Toronto and Ottawa Developers, Planners, and Municipal Finance Officials, 1994.
- [8] R. Kelly, "Designing a Property Tax Reform Strategy in Sub-Saharan Africa: An Analytical Framework applied to Kenya." HIID Discussion Paper 707. Cambridge, MA: Harvard Institute for International Development, 1999a.
- [9] Government of Kenya, CBS, World Food Programme and Government of Kenya, Community Based Food Aid Targeting and Distribution in Kenya: Field Manual, 1996.
- [10] R. Kelly, Property Taxation in Kenya in R.M. Bird and E. Slack (eds), *International Handbook of Land and Property Taxation*, Edward Elgar Publishing Limited, UK, pp. 177-188, 2001.
- [11] C. Kariuki, N. Nzioki and J. Murigu, 'A Review of the Training Needs for Revenue enhancement for local Authorities in Kenya', University of Nairobi Department of Real Estate and Construction Management, 2009.

# Using geospatial technologies to support compulsory land acquisition in Kenya – a case study of Kanunga – Nyaga road in Kiambu County

Mary N. Kamunyu, David N. Kuria and Kenneth Mubea

**Abstract** - Governments have power to compulsorily acquire land or other interest in land for a public purpose subject to prompt payment of the compensation to the affected persons. The process of land acquisition involves several government departments which have different mandates depending with the purpose of the acquisition. In several instances departments involved have been seen to be disjointed hence causing gaps and unfinished work in the whole process. In a number of occasions the government has acquired land yet delayed occupation of the same, the case study in this research being an example. This has resulted to encroachment of the already acquired land either knowingly or unknowingly by the same people who were compensated or new entrants who have purchased land after the compensation has been done, sometimes unaware of the state of the land. There has been failures in updating of documents and maps with the acquired data hence causing great losses where developments have been demolished especially where land has already been acquired for road construction. Ownership documents, the title deeds, have failed to have the acquired acreage deducted and the maps/plans with the National Mapping Agency fail to be updated. This paper looks at how best to use GIS in the process of land acquisition, bringing together all the information in all the departments involved for a one-stop-shop. In this research, the Registry Index Maps (RIMs) from the Ministry of Lands, Survey Department, and the road layout from the Roads Department were overlaid and parcels identified which are yet to surrender the acquired acreage. With GIS a list of all affected parcels together with the relevant attributes can be extracted and forwarded to the relevant departments as seen necessary. This will enhance transparency in operations where there are overlapping mandates and highlight gaps in the whole acquisition process.

**Keywords** - Compensation, GIS, Land acquisition, overlaid

## Abbreviations and Acronyms

GIS – Geographic Information System  
KeNHA – Kenya National Highway Authority  
LIMS – Land Information Management System  
NLC – National Land Commission  
RIM – Registry Index Map

Mary N. Kamunyu, Dedan Kimathi University of Technology, (Phone: +254722990663; E-mail: [nmary.kk@gmail.com](mailto:nmary.kk@gmail.com)).

David N. Kuria, Dedan Kimathi University of Technology and National Land Commission (e-mail: [dn.kuria@gmail.com](mailto:dn.kuria@gmail.com)).

Kenneth Mubea, Dedan Kimathi University of Technology, (email: [kpwmubea@gmail.com](mailto:kpwmubea@gmail.com)).

## I. INTRODUCTION

In compulsory land acquisition a property is taken over for public use without private negotiations or consent of the owner, but with a just and prompt compensation. Compulsory acquisition is the tool governments use to acquire private property in order to provide public facilities for enjoyment by citizens. Corporations, companies and persons can also acquire land under the Land Acquisition Act, now repealed by The Land Act, 2012 [1].

In Kenya, there are numerous cases where the power to acquire land compulsorily is conferred by an Act of Parliament to the Government or other public authority in order to carry out schemes for the benefit of the community as a whole. Such legislation include The Land Acquisition Act, The Land Act, The Water Act and The Electric Power Act [2].

The Constitutional of Kenya 2010, defines the term “land” in Article 260 to include: - the surface of the earth and the subsurface rock, any body of water on or under the surface, marine waters in the territorial sea and the exclusive economic zone, natural resources completely contained on or under the surface and the air above the surface.

Compulsory acquisition is also referred to as eminent domain and is the power possessed by the state over all the property in the country. Through this power the government is able to acquire land compulsorily for the public use. This acquisition must be done according to the law [3]. Two general conditions can be set up to assess what is a public interest. Firstly, the socio-economic benefits of the acquisition must outweigh its disadvantages, that is, it has to be profitable. Secondly, the purpose of the acquisition has to be important or *essential*. It is a debatable issue, which purposes are to be deemed “important”. But included is normally the basic infrastructure needed for individual properties to function in a good way, such as roads and utilities for water and sewage, electricity and telecommunications.

Conditions that the government must satisfy to exercise this power include: - Land must be private property, the government must have the capacity to take physical possession of the property, the property should always be for public purpose. If the acquisition is not for the public benefit then it will be an illegal acquisition therefore the property cannot be used for any other purposes. For instance land that

was left unused in the construction of a road cannot be sold or used for any other purpose and should be marked as road reserves. The private owner of the land must be paid compensation in full. The compensation should be adequate and should be paid without any unreasonable delay. There are many factors to be considered such as; the expenses incurred by a person who has to change his residence, damage caused by the publication in the Gazette, damages that may be incurred on the owner's other property.

Compulsory land acquisition by the Government should end at the point where the Government takes possession of the land it has acquired. This has not been the case in Kenya in quite a number of cases resulting to encroachment into the already acquired areas either knowingly or unknowingly.

Compulsory land acquisition is a very expensive venture for the Government. For example the Daily Nation on 17th June, 2014 wrote that the compulsory land acquisition for the first phase of the standard gauge railway line from Mombasa to Nairobi would cost Kenya shillings ten billion (ksh 10 B).

This justifies why the government should take possession of the land it has acquired soon after full payment.

The acquired acreage also in some cases is not deducted from the total acreage in the ownership documents or even noting at the Land Registries that the Government has some interest.

The Registry Index Maps (RIMs), Survey Plans and the Deed Plans are used for registration and the reason why they should depict the correct information for each and every parcel of land. Any proposed development on the parcel of land is done as per the RIM or survey plan proving the extent of the parcel. For example, a sub-division scheme or building plans will only be approved if they conform to the RIM or survey plan.

There have been many cases of demolition of buildings due to the developments being on the road reserve either knowingly or unknowingly. It is hence important to protect developers who may wish to purchase land yet with even due diligence do an official search and purchase maps then later learn that a road had been acquired and owners compensated yet not mapped!

When acquired land is not marked both on the ground and on maps and the land registry does not show government

interest on the land, then it shows that this public land is unprotected and ownership not yet transferred to the Government. These has caused embarrassing situations for Government departments like the case of Rironi demolition of a four storied building under construction in Kiambu County. The owner had purchased half an acre from the original owner and obtained a title deed. The parcel was even amended on the RIM! The RIM indicates the Nairobi – Nakuru highway as 40 meters wide while the Department of roads said that the acquisition increased the road width to 80 meters wide. The information with the Roads department was not recorded in the anywhere in the documents held by the Lands Ministry.

The main objective of the research was to identify how much land is yet to be surrendered to the Government by the compensated land owners in the study area and recommend measures to stem this failure to take possession. The Specific Objectives were to recommend a procedure in the compulsory land acquisition for a successful completion of the process, propose an effective procedure to be followed to map the already acquired yet not mapped roads, using GIS technologies, quantify the respective parcels of land that have not yet been taken over and prepare a report on the parcels that are in contravention of the acquisition process.

## II. MATERIALS AND METHODS

### A. *The Study Area*

Kiambu County is one of the forty seven counties in the Republic of Kenya and is located in the central region. It covers a total area of 2543.5 sq km. It borders Nairobi and Kajiado counties to the south, Machakos to the East, Murang'a to the north, Nyandarua to the North West and Nakuru to the West.

The County lies between latitudes 0° 25' and 1° 20' South of the Equator and longitude 36° 31' and 37° 15' East.

The County has a good road network with a total of 2033.8Km of road under bitumen standards, 1480.2km under gravel surface and 430.1km under earth surface. There is great need to improve the condition of the roads since during the rainy season most of the roads become impassible [4].



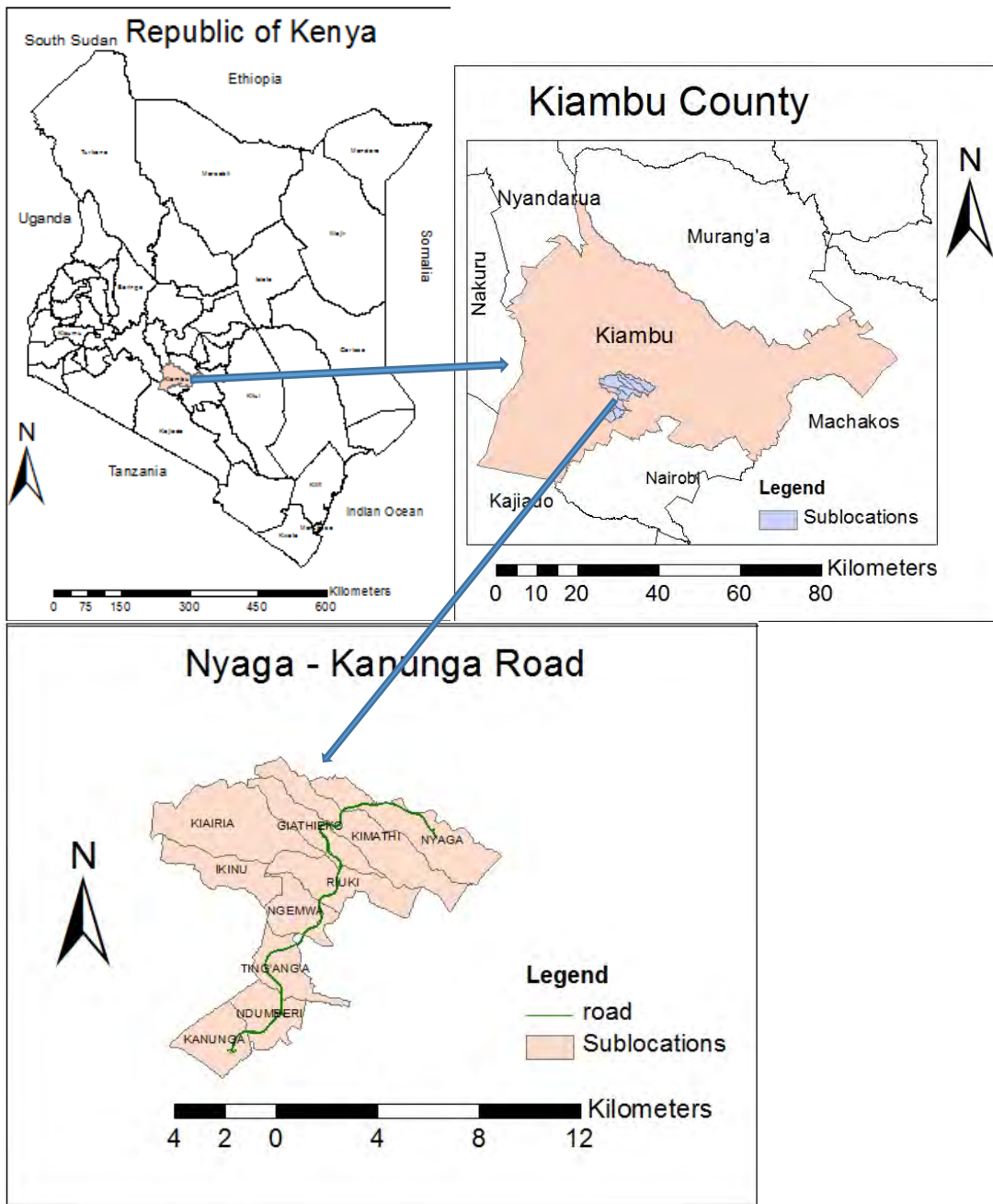

Fig. 1: Location of the study area

The County has twelve sub-counties and the road under study passes through three sub-counties which are Kiambaa, Kiambu and Githunguri. It starts at Kanunga sub-location in Kiambaa, proceeds to Ndumberi then Ting'ang'a in Kiambu sub-county and then to Githunguri sub-county through sub-locations Ngewa, Ikinu, Kiairia, Giathieko, Kimathi and finally Nyaga.

Average holding size of land in the county is approximately 0.36 ha on small scale and 69.5 ha on large scale. The fragmentation of land has made it uneconomical and hence majority of the farms are converting their farms into residential plots to supplement the meagre income from the

farms.

### B. Methodology

Both primary and secondary data sources were used. Thirty six (36) Registry Index Maps from the Director of Surveys and five of the proposed Kanunga-Nyaga Road Maps from the Kenya National Highways Authority (KeNHA) were used. The gazette notices were obtained from the National Archives and used to identify the parcels that were compensated for.

The questionnaires were administered to land owners, local Chiefs and relevant professionals. The questionnaires assisted to assess the effectiveness of the Land Acquisition process

TABLE I  
REGISTRY INDEX MAPS (RIMS) USED

S/No.	Registration Section	Sheet Nos.	No. of sheets
1	Kiambaa/Kanunga	4, 6, 7, Township	4
2	Ndumberi/Ndumberi	3, 5, 6, 8, Township	5
3	Ndumberi/Ting'ang'a	3, 4, 5, 8, 9, Township	6
4	Githunguri/Ikinu	14, 19	2
5	Githunguri/Kiairia	12, 19	2
6	Githunguri/Riuki	2, 3, 5, 6	4
7	Githunguri/Giathieko	7, 8, 9, 10, Township	5
8	Githunguri/Kimathi	6, 8	2
9	Githunguri/Nyaga	4, 5, 6, 10, 12, Township	6
<b>Total</b>			<b>36</b>

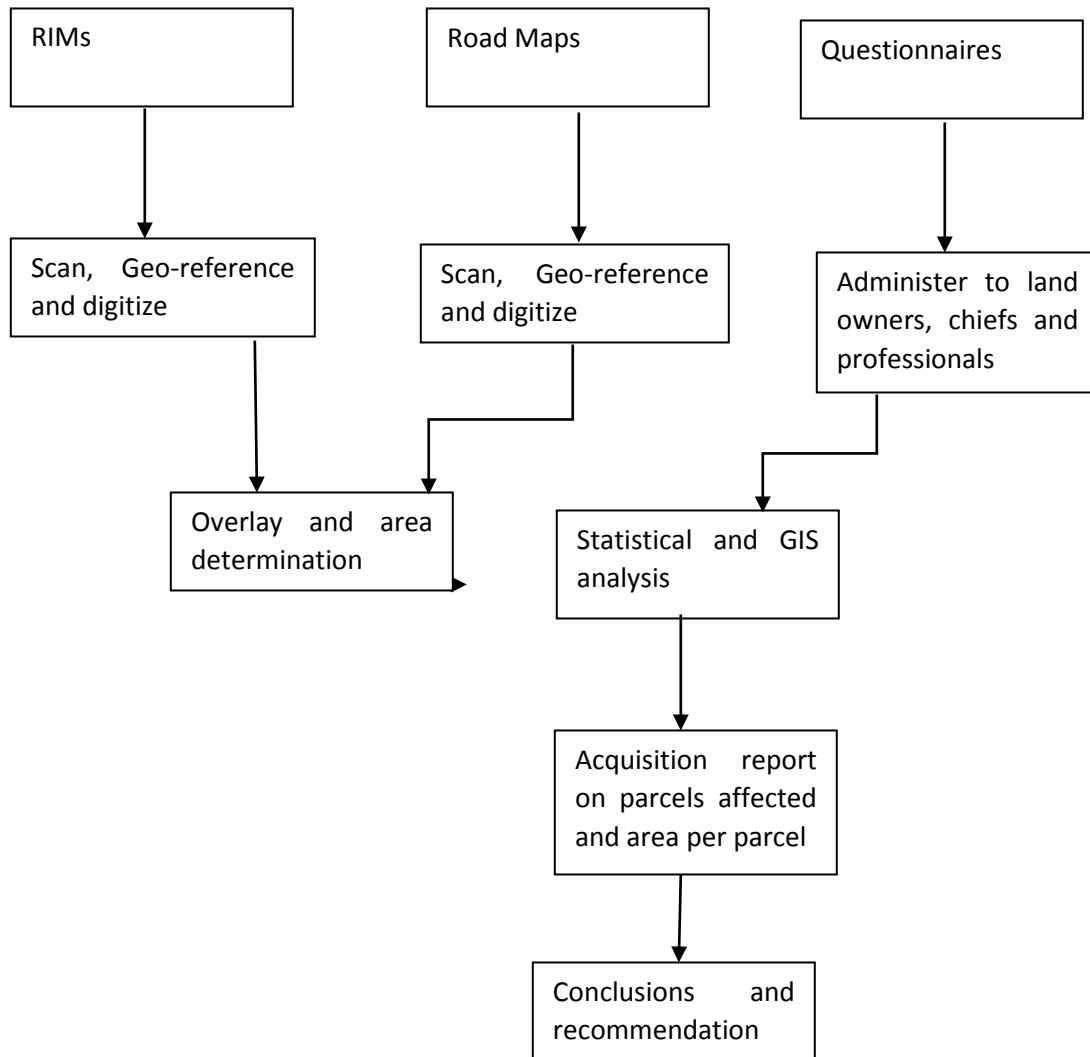

Fig. 2: Methodology flowchart

Two questionnaires were developed one to the land owners and the other to the relevant professionals and the local chiefs. Purposive sampling was used where the chiefs assisted in identifying the respondents whose parcels were affected by the acquisition. 160 and 22 questionnaires were distributed with an 83 and 86 percent response for questionnaire 1 and 2 respectively.

A total of 1941 parcels that are close to the acquired road were digitized. 649 parcels were affected by the road after the intersection of the parcels layer and the road layer as compared to 338 parcels listed in the Kenya gazette. The increase is associated to subsequent sub-divisions of the parcels after acquisition.

### III. RESULTS AND DISCUSSIONS

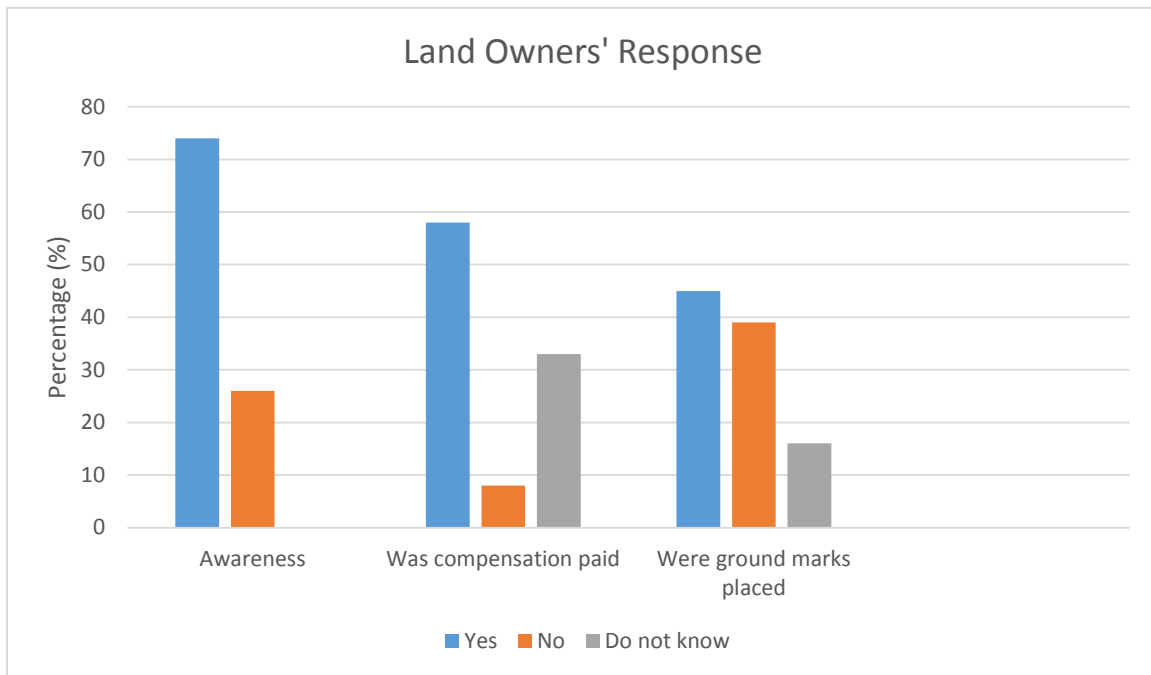

Figure 3: Land Owners' Response

From Figure 3 it can hence be concluded that land owners were aware of the acquisition and were compensated

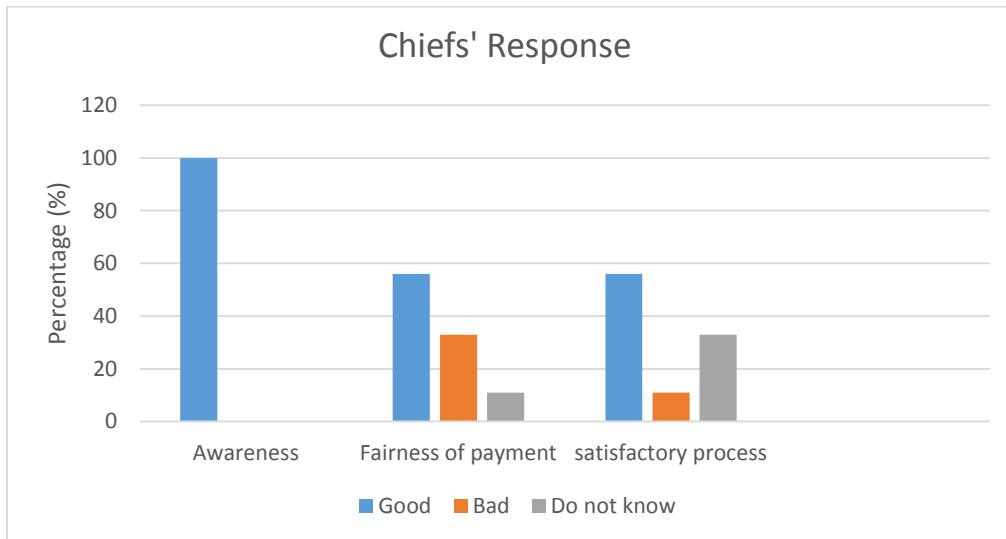

Fig. 4: Response from the Chiefs

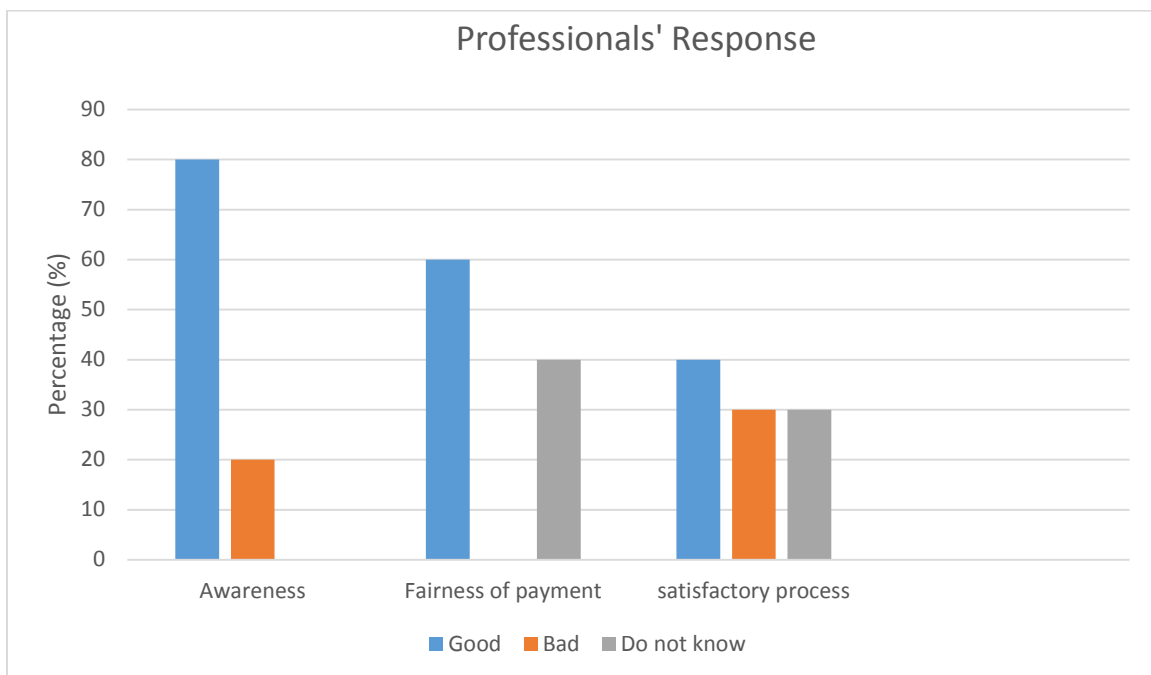

Fig. 5: Response from Professionals

All professionals based in Kiambu and the chiefs were aware of the acquisition and were of the opinion that the amount paid was adequate, fair and equitable as per the time of acquisition. Though most respondents said they were

satisfied with how the acquisition was done then, others felt that the failure of the government to take possession shows that the acquisition was not justified.

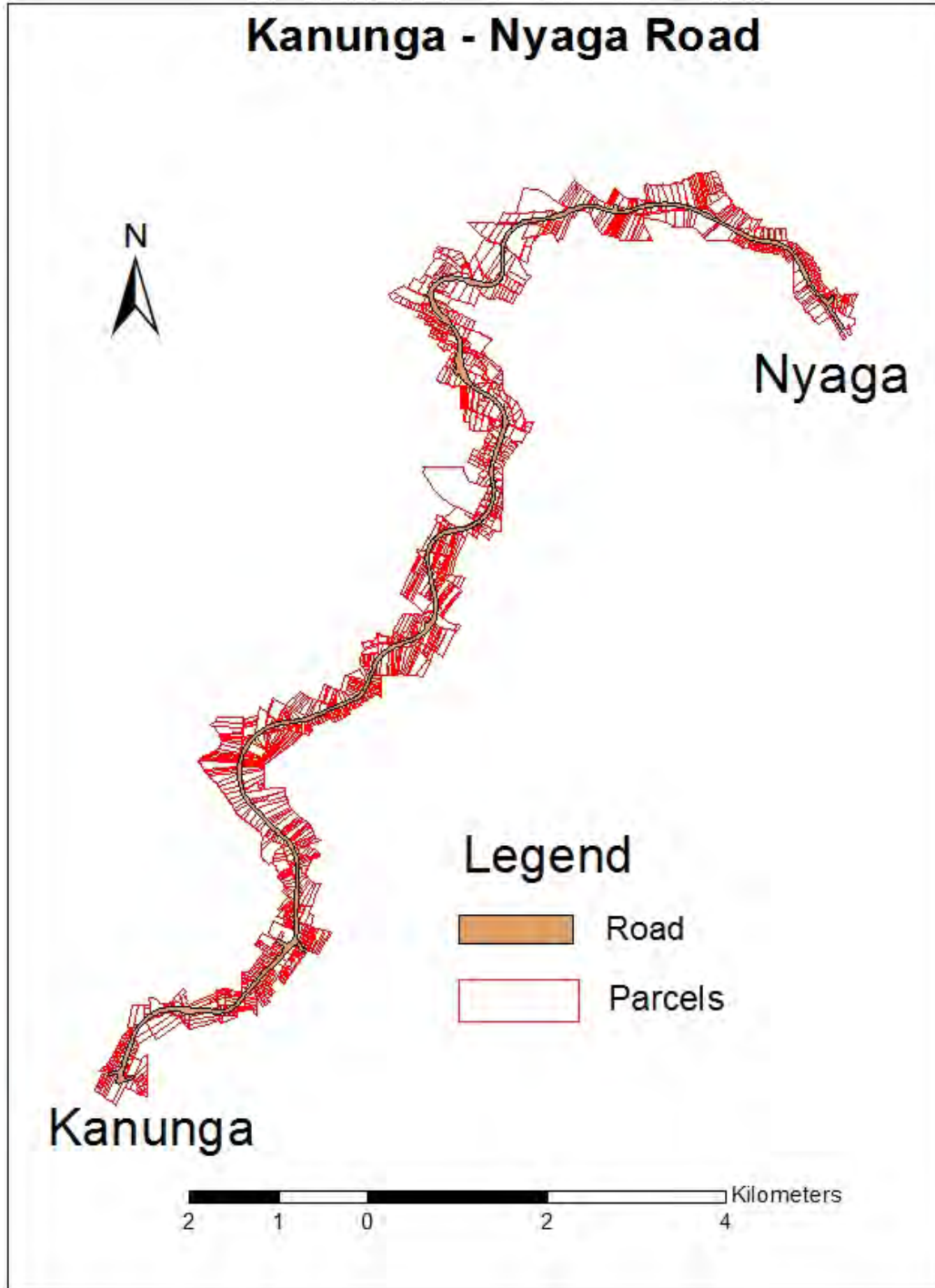

Fig. 6: The digitized layers

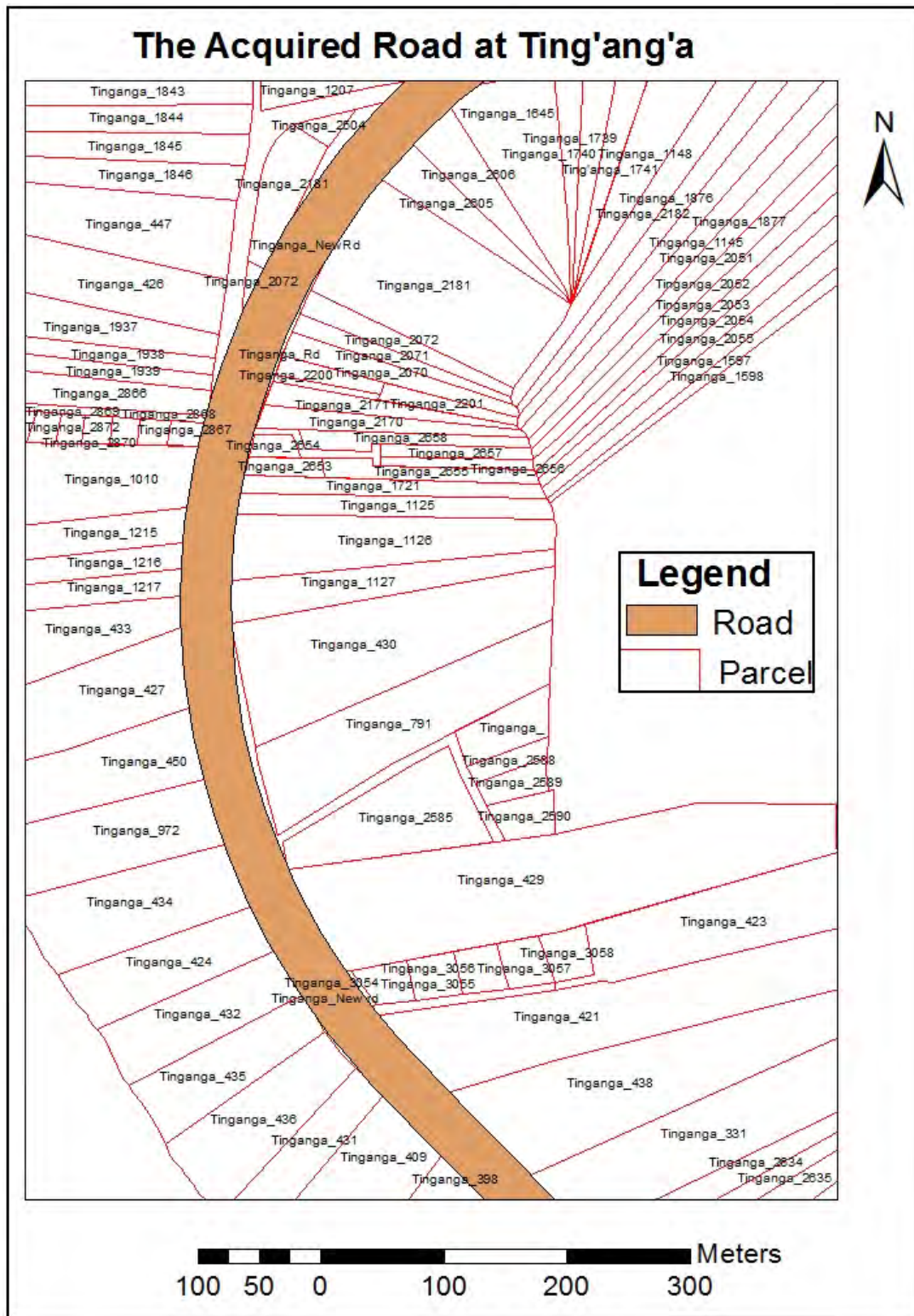

Fig. 7: Acquired road at Ting'ang'a

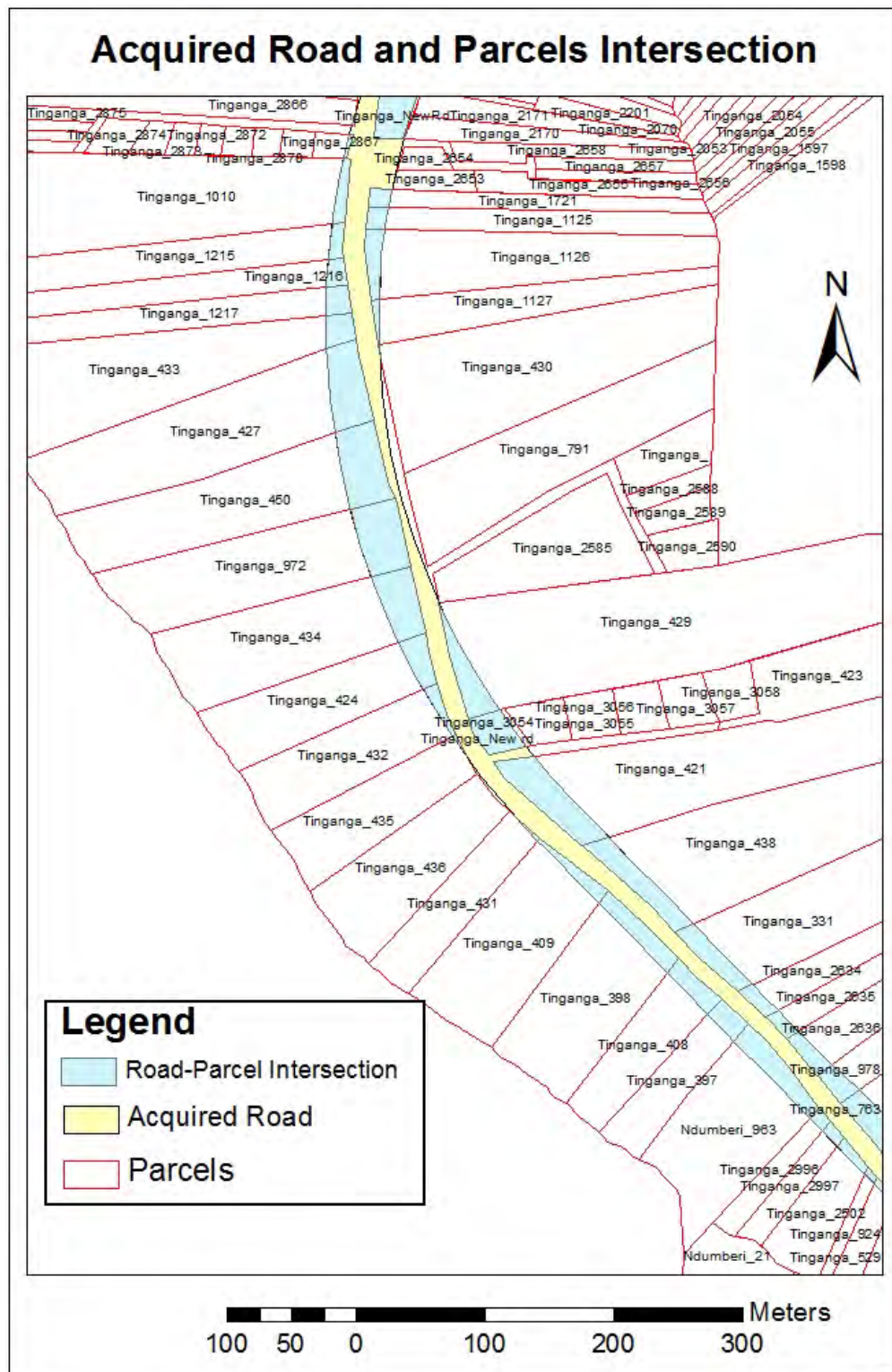

Fig. 8: Extract of the intersection of the parcels and road layers

TABLE II  
EXTRACT OF THE LIST OF ALL AFFECTED PARCELS

<b>Parcel_ID</b>	<b>area_ha</b>	<b>AcqArea_Ha</b>	<b>AqArea_Percentage</b>
Ndumberi_NewRd	0.11941731890	0.11236699847	94.10
Giatheko_107	0.43865715031	0.14799971777	33.74
Giatheko_109	0.37780910546	0.14614002857	38.68
Giatheko_132	0.33138566839	0.29350653569	88.57
Giatheko_134	0.31664345031	0.26732716765	84.43
Giatheko_135	0.29293519508	0.16769369829	57.25
Giatheko_143	0.40817650503	0.00351805421	0.86
Giatheko_158	0.86072956182	0.13028838533	15.14
Giatheko_171	1.75806727925	0.11464563681	6.52

TABLE III  
EXTRACT OF LIST OF PARCELS YET TO SURRENDER

<b><u>Parcel ID</u></b>	<b><u>area ha</u></b>	<b><u>AcqArea Ha</u></b>	<b><u>AqArea Per</u></b>
Giatheko_808	0.45490013806	0.20193603970	44.39
Giatheko_T140	0.09616450685	0.00091880411	0.96
Giatheko_T20	0.07545551432	0.02750728869	36.45
Giatheko_T21	0.07633778678	0.07015469359	91.90
Giatheko_T22	0.09164713598	0.09164713598	100.00
Giatheko_T223	0.04642524982	0.03673433642	79.13
Giatheko_T23	0.08385241521	0.00550296808	6.56

It is evident that irrespective of the acquired acreage from Table II and III that parcels remained intact on the RIMs



TABLE IV  
ACQUIRED ACREAGE ON GAZETTE NOTICE COMPARED WITH THE ACHIEVED FOR TING'ANG'A PARCELS

Parcel_ID	area_ha	AcqArea_Ha	Gazt_AcqArea_Acres	Gazt_AcqArea_Ha	Difference	percentage Diff
Tinganga_1007	0.33145659744	0.09034768261	0.35	0.141643059	-0.05129537688	-36.21
Tinganga_1010	3.21819675312	0.03942211655	0.054	0.021853501	0.01756861594	80.39
Tinganga_111	2.78140274129	0.47758807472	1.7	0.687980575	-0.21039249995	-30.58
Tinganga_331	1.82855790971	0.09577384459	0.15	0.060704168	0.03506967624	57.77
Tinganga_341	0.95575156293	0.23952205131	0.66	0.267098341	-0.02757628944	-10.32
Tinganga_430	1.87436314715	0.00089771865	0.007	0.002832861	-0.00193514254	-68.31
Tinganga_431	0.55565033322	0.00391939195	0.005	0.002023472	0.00189591967	93.70
Tinganga_432	0.77147102582	0.03034530388	0.03	0.012140834	0.01820447021	149.94
Tinganga_433	1.89213599525	0.05061447274	0.1	0.040469446	0.01014502717	25.07
Tinganga_434	1.21528948962	0.14709262097	0.31	0.125455281	0.02163733971	17.25
Tinganga_435	0.71322764362	0.00304512301	0.003	0.001214083	0.00183103964	150.82
Tinganga_437	1.55674464379	0.09986357463	0.12	0.048563335	0.05130023995	105.64
Tinganga_438	2.16067038926	0.14963236695	0.4	0.161877782	-0.01224541532	-7.56
Tinganga_450	1.34057760261	0.20413293085	0.4	0.161877782	0.04225514858	26.10
Tinganga_529	0.27911276767	0.02009489575	0.1	0.040469446	-0.02037454982	-50.35
Tinganga_638	0.28516523096	0.02275806412	0.2	0.080938891	-0.05818082701	-71.88
Tinganga_763	2.33785567928	0.21569986569	0.43	0.174018616	0.04168124974	23.95
Tinganga_767	0.26827616368	0.02686985433	0.2	0.080938891	-0.05406903680	-66.80
Tinganga_924	0.18397952323	0.00900568627	0.07	0.028328612	-0.01932292563	-68.21
Tinganga_960	0.18452888398	0.00152397978	0.08	0.032375556	-0.03085157668	-95.29
Tinganga_967	1.14067964178	0.03345068339	0.08	0.032375556	0.00107512694	3.32
		1.96160030275		2.205180089	-0.24357978629	-11.05

The differences were noted mainly as acreage computation discrepancies. This highly supports why GIS should be used in the acquisition process since the acreage obtained is accurate hence compensation based on acquired acreage is assured.

The use of Google Earth and Satellite imagery further enable the analysis of the developments that are on the acquired land.



Fig. 9: An extract of the Intersected layer on Google Earth at Ndumberi Township



Fig. 10: Land Acquisition Process [5]

With land evoking a lot of emotion in Kenya, the national land policy has principles that provide for equitable access to

land, secure land ownership, effective regulation of land development, sustainable land use, access to land information,

efficient land management, vibrant land markets and transparent and democratic administration of land [6]. With the policy's guiding values especially of transparency and cost effectiveness, the process of land acquisition should aim at meeting them. The creation of Land Information Management Systems (LIMS) will ensure availability of land information for decision making in land administration and management [7].

The National land Commission is the main player in the Acquisition process (see Figure 10) as mandated by the Land Act, 2012 and hence should ensure that all institutions involved fulfil their functions. Other players include, the national and county governments, State Agencies, the land registrars, government printers, national/county survey office and the judiciary.

#### IV. CONCLUSION AND RECOMMENDATION

The process of compulsory acquisition should only start after the government has ensured reasonable justification for causing any hardship on the interested persons as required in Article 40 (3) of the Constitution. The acquiring body should sensitize land owners and have adequate public participation before and during the process, Expedite survey and valuation process and ensure clear ground marks are placed. Compensation for disturbance should be considered and Streamlining of documentation between departments and sharing of data. NLC should link up the departments. Sufficient funds should be acquired to complete the whole process and take possession immediately else ensure acquired land is protected from encroachment.

With geo-referencing of all parcels and the opening of National Spatial Data Infrastructure, greater protection of

acquired land is expected in future.

The results of this research may be used by the land registrar to register government interest on the parcels and the relevant Roads Authority to mark and protect the acquired land. The County Government may also use it to follow up on the construction of the road by KeNHA.

#### ACKNOWLEDGEMENTS

I wish to sincerely thank my Supervisors Dr David Kuria and Dr Kenneth Mubea who have tirelessly moved each step with me advising and being available whenever I needed them. Likewise I am grateful for the support and advice from lecturers and other teaching staff at Dedan Kimathi University of Technology (DeKUT). Moreover, I extend my gratitude to staff at Kiambu and Nairobi Survey of Kenya offices who assisted with data collection and also to Joshua and Hilda for their support in digitization of data. Lastly, I am grateful to my family gave me all the support I needed.

#### REFERENCES

- [1] Nabutola, W. (2009). Compulsory Purchase and Land Land Acquisition in Kenya. FIG Regional Conference. Hanoi Vietnam.
- [2] Syagga, P. M. (1994). Real Estate Valuation Handbook. Nairobi: Nairobi University Press.
- [3] Warira. (2012, September 13). resources/ compulsory acquisition of land. Retrieved from kenyaplex: 4972
- [4] Ministry of Devolution. (2012). Kiambu County Development Profile 2013. Nairobi: Government printers
- [5] (2012). The Land Act, 2012. Nairobi: Gorvenment Printers.
- [6] Nabutola, W. (2012, October 18). news/article - The Law of Compulsory land Acquisition. Retrieved from the-star: 92578
- [7] Ministry of Lands. (2009, August). National Land Policy. Nairobi, Kenya: Government Printer. Sec 160.

# Development of A WebGIS Supported Road Traffic Accident Data Management System: A Case Study Of Nairobi County

Joseph Nanzala Munyendo, David Kuria and Kenneth Mubea

**Abstract**—This research project work seeks to improve road traffic data storage and accessibility through the use of WebGIS by creating a road traffic accident data management system. A case study method was employed with Nairobi County as the study area. An Accident Management System was developed encompassing a database managed by PostgreSQL and a webserver. It has the advantages of having centralized data, readily accessible as opposed to the current status where data access is constricted by office working hours and manual data requisitions that take time to respond to. Simple statistical analyses are afforded by this system for data comparisons, estimations and inferences. The location of accidents usually given in textual formats has been addressed hence viewing of accident locations on maps is possible.

**Keywords**—Database, Geospatial Information Science, WebGIS.

## I. INTRODUCTION

There is a palpable desire and urgency to effectively address the fatalities and serious injuries resulting from road traffic accidents evidenced by the many studies and reports carried out both globally and locally to address them. [1 - 6].

Studies have shown that 90% of the global road traffic accident statistics occur in low and middle income countries like Kenya [7, 8] where over three thousand people are killed as a result of road accidents, with an average of 7 deaths from 35 accidents per day [9]. It has also been shown that the majority of these fatalities and serious injuries occur in the economically active population of 15-59 years [10], thereby curtailing economic activities of affected countries.

The United Nations, the World Health Organization, the African Development Bank, United Kingdom's Transport Research Laboratory, African Transport Policy Program, Kenya Road Safety Network, Institutions of higher learning and individual researchers among many others have dedicated considerable financial resources and time to find ways of mitigating the Road Traffic Accident problem.

In the year 2004, the then president, His Excellency President Mwai Kibaki, acknowledged that over 3000 Kenyans got killed on the Kenyan roads every year, most of

them between the ages of 15 and 44 years. He asserted his government appreciated that road traffic injuries were a major public health problem amenable to prevention [11]. Calls for concerted efforts for effective and sustainable prevention have been made at national and global fora to address this state of affairs. This did lead to a number of measures as a redress to the road traffic accidents menace.

Globally the United Nations, in its Sixty-fourth session, Agenda item 46, proclaimed the period 2011–2020 as the “Decade of Action for Road Safety, with a goal to stabilize and then reduce the forecast level of road traffic fatalities around the world by increasing activities conducted at the national, regional and global levels” [12].

At national level, the National Transport and Safety Authority (NTSA) was established through Act Number 33 of 2012 to minimize loss of life through road accidents and a raft of rules introduced via amendment of section 12 of Cap 403 of the laws of Kenya to address road traffic accident crashes in the country. These included [13]: Overlapping, obstruction, driving on pavement or through a petrol station to avoid traffic, contravention attracting a fine of Kshs 100,000 - 300,000 or one year in jail or both, over speeding which attracts a fine of Kshs 10,000 or 3 months imprisonment or both, careless Driving having a penalty of Ksh 500,000 or 10 years imprisonment or both. If it leads to death, the penalty is Life Imprisonment, driving under influence of alcohol which has a fine of Ksh 500, 000 or ten years in jail or both, PSV Operators to adhere to the uniforms' and badges' rules, Motor Cycle operators to carry one passenger only and the passenger and rider must be in reflective vests and helmets – infringement attracts a fine of Kshs 10,000 and in default 12 months imprisonment.

These efforts were supplemented by Sessional paper No. 10 of 2012 on Kenya Vision 2030 [14] which outlined a national road safety program targeting reduction of incidences of road crashes and their impact on the Kenyan Economy and suggested computerized information maintenance management systems program to manage roads, bridges and pavement.

Still the numbers remain unacceptably high both globally and at national level. For the Kenyan case, road crashes have been shown to be steadily increasing year after year [9]. Acknowledging the fact that the majority of the fatalities and serious injuries occur in the economically active population of 15-59 years [10], the need to attempt to prevent road accidents

Joseph Nanzala Munyendo, Institute of Geomatics, GIS & Remote Sensing (IGGRoS), Dedan Kimathi University of Technology (Email: [jnanzala@gmail.com](mailto:jnanzala@gmail.com), +254722498898)

David Kuria, The National Land Commission

Kenneth Mubea, Institute of Geomatics, GIS & Remote Sensing (IGGRoS), Dedan Kimathi University of Technology

by viable means becomes increasingly important. There has to be much better than the react-to-crisis basis way of tackling infrastructure issues [15] that is the norm in the country. Better methods of assembling and managing road traffic accident data than the current practices which rely on un-harmonized manual technologies that are slow and in the long run expensive need to be put in place.

It is with regard to the foregoing that a centralized Road Traffic Accident Data Management System accessible via the World Wide Web (WWW) is given as a solution. This is in line with international practice where systems using GIS have been developed for use in road traffic accidents' management for improving the efficiency and effectiveness of traffic accident countermeasures [16 & 17].

This paper addresses management of data, which is the cornerstone of all road safety activity and is essential for the diagnosis of the road crash problem and for monitoring road safety efforts [18], resulting from Road Traffic Accidents. Many decisions meant as interventions have been made, which, invariably in the short term, have not proved effective because of the failure to understand and account for variability in these accidents.

## II. LITERATURE REVIEW

Studies have shown that frequency of accidents can be addressed by adequately collecting and centrally storing data from road traffic crashes' in a spatial database for ease of management and most importantly to learn from it. In a report by the Transport Research Laboratory [19], the importance of such a system and its utilization is emphasized. Such a database would capture the road traffic crash situation where all crashes resulting in death and injuries are recorded, adequate detail surrounding the accident incident are inventoried – vehicle, road user, road environment, crash location accurately determined and recorded, and reliable output provided as needed.

Currently road traffic accident related data is managed by various players – mainly the Traffic Police Department, the National Transport and Safety Authority, Kenya Urban Roads Authority and Ministry of Health hold disaggregated data. Other organizations like the National Bureau of Statistics, Kenya Road Safety Network have aggregated data from the former institutions. The implication is that data is available in varying data formats and that accessibility regimes are different for each organization. Data extraction from existing storage is cumbersome at the least and at worst records might be missing all together. Manner of storage is mainly in analogue publications, meaning that retrieval is cumbersome and at worst inaccessible for cases of lost data. Further, locational information in the current data collection and storage – where accidents take place – is very much generalized. No attempt is made at determining and recording the geographical position of traffic incidences. A good indicator of the non-accurate accident location reporting and recording is in the manner of reporting black spots by the

Kenya Police Service [20], the National Transport and Safety Authority [21], Kenya Roads Board [22] among others.

This project work sets out to integrate data related to traffic accidents via a spatial database and employ use of communication technologies for a one stop data and information portal and for a wide reach via the WWW. These data is both spatial and descriptive. The system is to ensure readily available data at common standards for decision making support and research purposes. Such a system has been before proposed in earlier research [23].

Thus the main objective of the study was to use the ability of GIS in management of road traffic accident related data by developing a WebGIS Supported Road Traffic Accident Management System for Nairobi County.

Specifically, the objectives were;

- To develop a spatial database for road accident incidences in the Nairobi County;
- To develop a web user interface that accesses the database; and
- To construct a logic tier that links the database with the user interface.

The premise of this research is that good accident data management can aid better decision making which in turn would lead better policy formulation, focused road traffic legislation and informed traffic rules enforcement. This would eventually have a positive impact on the numbers in road traffic accident incidences.

The World Health Organization (WHO) recommends [24] road safety management as one of the six pillars that guide national road safety plans and activities over the Decade of Action for Road Safety [12]. This study will therefore aid the country's move towards meeting its obligation of stabilizing and reducing the increasing trend in road traffic fatalities and injuries by implementing this pillar. The web based road accident data management system will provide a one stop data portal and be accessible to multiple users through the web interface.

As a case study, it provides a learning and evaluation platform on a pilot basis before any nation-wide program is implemented and thus save the country on resources that could be invested in untried counter-measures. This idea of piloting programs is strongly supported by the Transport Research Laboratory, United Kingdom [25] who advances the importance of running road traffic accident countermeasures as pilot schemes so that they are properly evaluated and reported on before acted upon on a wider scale.

The road traffic accident data management system will have the following benefits: It will help the national government decide on Safety Policy supported by scientific evidence e.g. the night travel ban; It would guide national and county government authorities to reach appropriate decisions such as campaigns on drink –driving, child safety education; It would help identify design problems on the transportation network; It would be a one stop shop for road accident related data; It would help determine the true burden of Road Traffic Accidents; Highlight the inaccuracies and incompleteness of

current traffic accident data; and It would aid in the achievement of the Millennium Development Goals of reducing child mortality and reduction of extreme poverty and hunger by reducing the number of road traffic accident fatalities which involve children and family bread earners.

It is the opinion of the researcher that the current way of managing information surrounding accident occurrences is not adequate. Hence the choice of WebGIS as a management tool in this research. The application of GIS in data management has grown since the 1960s because of its great appeal in integrating all kinds of information and applications with a geographic (spatial) component into one manageable system, hence, allowing for the creation of a complete picture of a situation. Spatial and other kinds of information are brought within a single system allowing for manipulation and display of geographical knowledge in new and exciting ways. Further, the ability to separate information in layers and combine it with others gives GIS great potential as research and decision-making tool [26].

This ability of data layering has been greatly used in incident and traffic management systems with high efficiency, with GIS' capability of integrating data feeds and sharing dashboard views exploited [27]. This feature makes it ideal for getting a comprehensive depiction of the present road traffic accident situations. For instance, traffic operations managers can observe traffic jams and other such information so that they can quickly respond to the situation. They can also share their views with the public through websites and update the drivers on any information like road conditions, travel conditions, etc.

GIS, being a computerized system, facilitates data entry, data analysis and data presentation [27]. Such data is usually organized in a database, a repository of data, designed to support efficient data storage, retrieval and maintenance. Data in a database is stored in various forms including tabular, hierarchical and graphical forms [28]. It is the tabular form, referred to as relational database that was exploited in this research. Here data is stored in a simple but versatile way in two dimensional tables, also called relations. The relation columns have attributes while its rows (tuples) contain information about the attributes.

Various researches have shown that for an accident database, the needed data for an ideal Road Traffic Accident Data Management System would include vehicles and people involved in accidents, the location of the accidents, time and environment/weather conditions existing during the accident incident, the cause of the accident and the consequences of the accident. This information relating to an ideal accident database was gathered from various research studies done [29, 30].

Studies and applications in the use of GIS in Road Traffic Accident Management have been done successfully elsewhere where road traffic accidents were as prevalent and disconcerting as in Nairobi County. A prototype Geographic Information System and Road Accident View System (GIS-RAVS) [31] was developed in Malaysia to reduce the number

of traffic accidents. The system was developed to afford data entry and querying. Access of the system was via desktop computers.

Agoki [32] studied the characteristics of road traffic accidents in the country in order to develop accident predictive models for Kenya. The study was evidently addressing the alarming number of traffic accidents on the roads.

Mwatela [23] used GIS to analyze causes of RTAs in Kenya. An actual database was not created but advanced the benefits of road crash database which would allow for analyses of RTAs and facilitate fast retrieval of information. He acknowledges that GIS has the advantage of affording easy system updates when there is need.

W. Odero, M. Khayesi and P. M. Heda [9] studied road traffic fatality trends in Kenya and showed that traffic crashes and the resulting casualties were on an increasing trend. These conditions were replicated in the then Nairobi, Rift Valley, Coast and Eastern Provinces because of high concentration of human population, high road network density and connectivity. In their discussion, they highlighted the incompleteness and inaccuracies of available data on road traffic accidents. The recommendation of the study was that "accurate and reliable traffic injury data can help inform decision makers, stakeholders and the public about the magnitude of the problem and intervention options that have proven effectiveness".

In a research carried out by E. K. Reshma and S.U. Sharif [33], the results did show the existence and location of black spots on roads in South Bangalore, India. Proper data collection and storage for accurate road accident data sets was recommended.

In a study detailing the characteristics and availability of fatal road-crash databases worldwide [30] it was learned that webGIS enabled accident management systems had been established elsewhere and that in such regimes the number of road traffic crashes were considerably lower when contrasted with countries where road accident data management was not managed properly, such as Kenyan.

Other studies have been done at both undergraduate higher levels that address aspects of road accident incidences. For instance, Nabende [34], then a student at the University of Nairobi studied factors contributing to Bodaboda taxi related traffic accidents in Kakamega Municipality, Kenya. Chitere and Kibua N. Thomas in their article 'Efforts to Improve Road Safety in Kenya looked at achievements and limitations of reforms in the Matatu Industry [35]. Nyangweso [36] studied the existence of black spots on Nairobi roads. Kipnetich [18] carried out a study on application of GIS Mapping and Analysis in mapping of road traffic accident incidences on Nakuru – Eldoret Highway road.

On accident reporting, the National Transport and Safety Authority (NTSA) avails daily accident reports in excel and pdf formats on enforcement, though the reports are not daily as envisioned. Kenya Urban Roads Authority also occasionally reports on accidents [21 & 22].

Thuo [37] designed a system to manage the entire traffic environment in the Central Business District in Nairobi. While the system was GIS aided, there is no evidence that it was availed to users via the WWW. Thus whereas it could be deployed to address road traffic accidents, knowledge of its existence was confined to a small group of people and its usage limited to people exposed to GIS software and in particular in ArcGIS.

A ‘Road Safety Seminar’ held in the Republic of Tanzania in the year 2009 organized by the United Nations Economic Commission for Africa discussed “A Way Forward for Reducing Accident Fatalities by Half by 2015” [2]. Road Traffic Accident Data Management was discussed and a recommendation made for participating states to harmonize their road safety data to ensure comparability.

### III. METHODS AND MATERIALS

Experimental survey method was employed where case study option was adopted, with Nairobi County, the study area, considered a true representative sample of the population - country Kenya with regard road traffic accidents.

#### A. STUDY AREA

The country’s political, social, cultural and economic capital is located within the boundaries of the County. It is one of the forty seven (47) counties created as administrative units provided by the Constitution of Kenya, 2010. It is bordered by Kiambu County in the North and North West, Machakos County in the East and South East and Kajiado County in the south and south east. It is administratively divided into three sub-counties with a total of seventeen constituencies. The study area is depicted in Fig. 1 below.

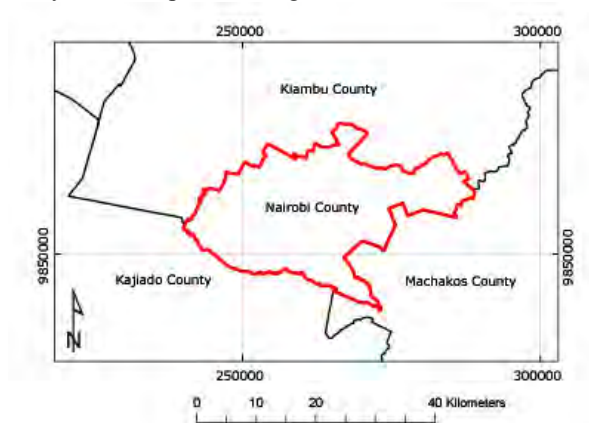

Fig. 1 Study Area

It has a population of 3,138,369 against the country’s population of 38,610,097 (approximately 8% of total population). This population is mainly comprised of migrants from other counties with male to female ratio of 0.51:0.49.

Nairobi County was chosen because of its high population density and extensive road infrastructure composing of all road classes in the country and a high number of registered

vehicles.

#### B. METHODS AND MATERIALS

The methodology adopted for this research to develop a webGIS enabled road traffic accident data management system using open source tools is illustrated in Fig. 2. The initial action was data collection and preparation. Then a relational database was created comprising of both spatial and non-spatial data composed of Nairobi road network data, Nairobi County Boundary, boundaries of neighboring counties, accident statistics, country and county population statistics, police stations and health facilities.

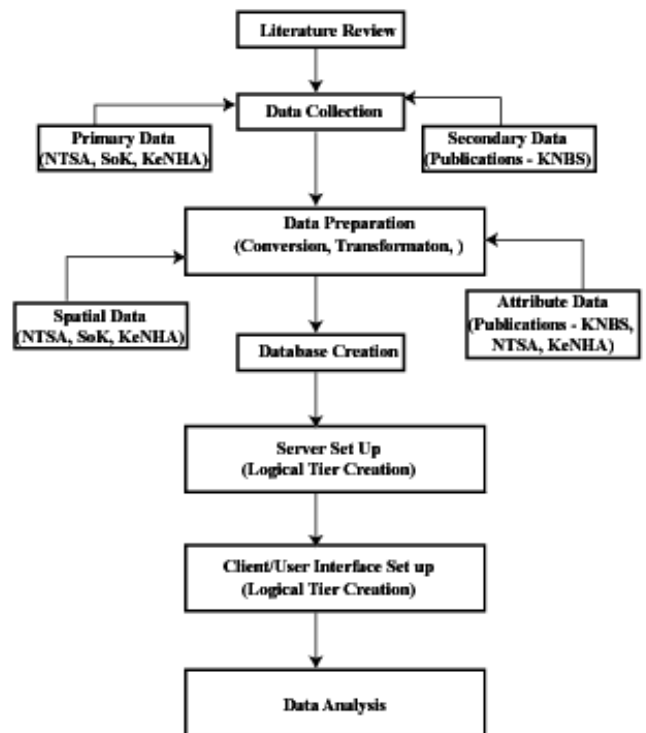

Fig. 2 Research Methodology

Acknowledging that the development of a road traffic accident data management system entailed data needs identification, data collection and harmonization, database creation, client layer creation and logic layer development, implementation was phased out as shown in Fig. 3 below.





Fig. 3 Phased Implementation of the system creation

Having identified the data requirements from previous researches, the next action was road accident data collection and preparation. These data both spatial and non-spatial, comprised of Nairobi road network data, Nairobi County Boundary, boundaries of neighboring counties, accident statistics, country and county population statistics, police stations and health facilities. All spatial data was projected into Universal Transverse Mercator projection on Arc 1960 Ellipsoid using DNRGarmin, a free source program for datum transformations. Then this data was prepared and assembled in Quantum GIS (QGIS), an open source GIS program.

Accident Statistics, Hospitals and Police Stations data were provided without spatial information. To address this shortcoming, their locations were inferred from Google Earth Imagery where location was marked and saved as Keyhole Markup Language (KML) files. These were then loaded in QGIS and converted to shape-files and attributed accordingly. An illustration is given in Table 1 of Hospitals Data and location inference as described above of one of the hospital facilities in Fig. 5.

Table 1 Hospital Facilities Data without Locational Information

Code	Facility Name	Type
19550	Meridian Medical Centre	Medical Clinic
	Kenyatta National	Referral
19463	Hospital	Hospital
13091	Mid Hill Medical Clinic	Health Centre



Fig. 5 Position of Kenyatta National Hospital on Google Earth

In a similar manner, spatial information was assigned to hospital, police station and reported accident locations. As a result of this, it was possible to overlay these datasets on the roads data set as shown in Fig. 6.



Fig. 6 Roads, Police Stations and Hospital Facilities (Black Boxes) overlay

A relational database was then created using PostgreSQL Relational Database Management System (RDMS) with PostGIS extension to handle spatial data. To achieve this goal, entities and their relationships were identified as illustrated in Fig. 7:

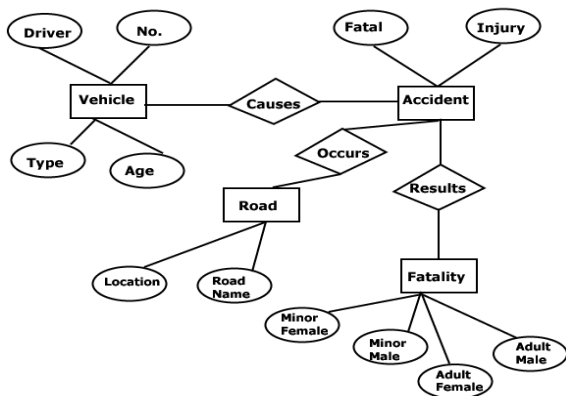

Fig. 7 Entity Relationship Diagram

Twenty entities and their attributes including six relations with spatial data - Roads, Railline, Hospitals, Police Stations, Roundabouts, and County Boundary were identified and used to create a database using PostgreSQL with PostGIS extension.

The spatial field was achieved by use of QGIS 2.0.1 where shape-files for these entities were created and attributed. Then by use of the Shp2pgsql (Command line data loader packaged with PostGIS for importing of standard ESRI Shapefiles and DBFs ) tool that is supported in the PostGIS extension, the shape-files were loaded into the database.

The spatial reference used was the Clarke 1880 Ellipsoid, UTM projection, Zone 37 South. Its code the database is EPSG 21037.

By use of table creation statement, tables were created using the Structured Query Language (SQL) that is packaged with PostgreSQL.

A logic layer was then created. This entailed the acquisition of a virtual hosting account with capabilities to support spatial databases and with GIS tools for administrative interface, development of PHP scripts and tables to provide the link between the data tier and the presentation tier (server side scripting). A remote server was acquired from AcuGIS Support at <http://cpanel.geospatialresource.com>.

The considerations for choosing this host were that it had to be available with no or little downtime, that it supported PostgreSQL spatial databases and that it afforded support of GIS tools including conversion of shapefiles to PostgreSQL and Geoserver. Indeed the acquired host had all these and more as evidenced in Fig. 4 below.



Fig. 7 Snapshot of Hosting Account page

Tools that enabled the achievement of this phase included Filezilla for uploading files to the webserver, Web scripting language Pre Processor Hyper Text (PHP), NetBean v8.0 text editor, and Geoserver for delivering of geo-associated database records.

For universal access of the database, a user interface was created. In this phase, a website was built using Hyper Text Mark Up Language (HTML), Case Styling Sheets 3 (CSS3) for HTML formatting, Client side OpenLayers to display map data on the web, and Gimp v2.8.2 for manipulating imagery.

#### IV. RESULTS AND ANALYSIS

##### A. RESULTS

A Road Traffic Accident Data Management System (AMSYS) was created for the purpose of managing road traffic accident data. The system is made up of a spatial database, a logic layer composed of PHP scripts and a user interface for viewing the data, uploading and downloading. Fig.8 illustrates how the disparate parts of the system are interlinked.

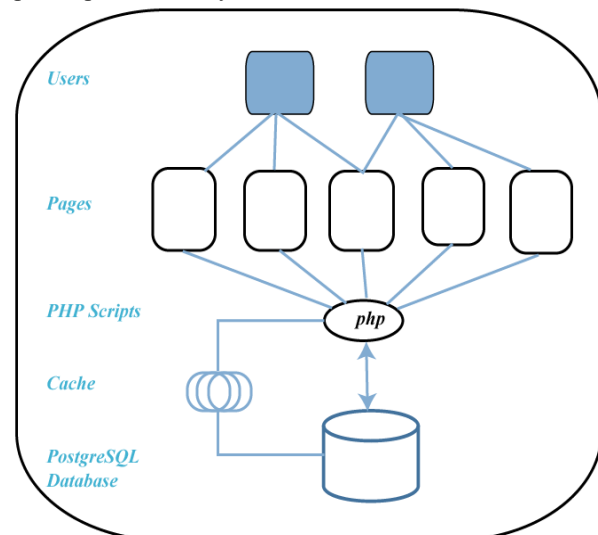

Fig.8 User Interface, Logic Tier and Database Architecture.

The created system can be accessed at <http://geospatialresource.com>.

The user interface of the system is illustrated in Fig.9. It has several interaction sections – view data section, a ‘Report an Accident’ section requesting for information for road accident

occurrences, a query section where the database can be queried for past crashes and related data with several user selectable options provided.



Fig.9 AMSYS User Interface Outlay.

For data viewing, a user can query data based on several factors, including accident victims – driver, pedestrian, passenger; age and gender – minor, adult, male or female among other factors. An instance of Driver Fatality table is provided in Table 2

df_id	Accident Code	Adult Male	Adult Female	Minor Male	Minor Female	Death Time		
1	RTA2013012	3	1	0	0	On Site	<a href="#">Edit</a>	<a href="#">Delete</a>
2	RTA2013022	2	5	0	0	On Site	<a href="#">Edit</a>	<a href="#">Delete</a>
3	RTA2013032	2	3	0	0	On Site	<a href="#">Edit</a>	<a href="#">Delete</a>
4	RTA2013043	3	3	0	0	In Hospital	<a href="#">Edit</a>	<a href="#">Delete</a>
5	RTA2013052	5	3	0	0	On Site	<a href="#">Edit</a>	<a href="#">Delete</a>
6	RTA2013062	3	4	0	0	In Hospital	<a href="#">Edit</a>	<a href="#">Delete</a>
7	RTA2013072	4	3	0	0	On Site	<a href="#">Edit</a>	<a href="#">Delete</a>

Table 2 Data view of Driver fatalities.

For user input, the system has a provision for road traffic accident reporting. A data collection form is provided with fields that require filling out as indicated in Fig. 10.



Fig. 10 Accident Data Collection Form

The system also affords map displays for visualization of accident sites – Fig. 11 - which can aid in revealing accident prone roads.

1. ACCIDENT LOCATIONS

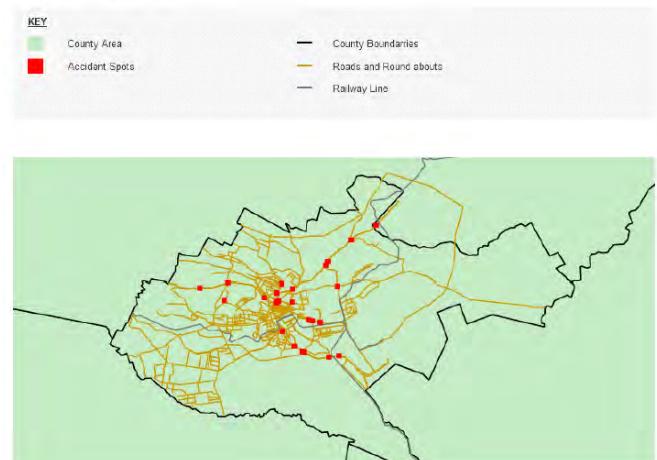

Fig. 11 Accident sites overlaid on the road network

B. ANALYSIS

The AMSYS developed is a ready-to-use solution for addressing the country's Road Traffic Accident Data Management. It provides a public website on the WWW which provides end-to-end experience for data users from data access to data analysis to sharing/dissemination. Further point and line displays are possible where lines represent the road network and points the accident locations as the system is a highly visual one. The road traffic accident management system provides for the publishing of accident statistics which can be found by people in a single place.

Boxplots are provided to give information about means of

various accident data groupings. From the boxplots' centers', spreads and shapes (skewness), one can infer patterns in the road traffic accident data. For example one can learn about driver fatality means of different epochs of time from which conclusions can be drawn on the efficacy of interventions put in place to address the road traffic accident menace.

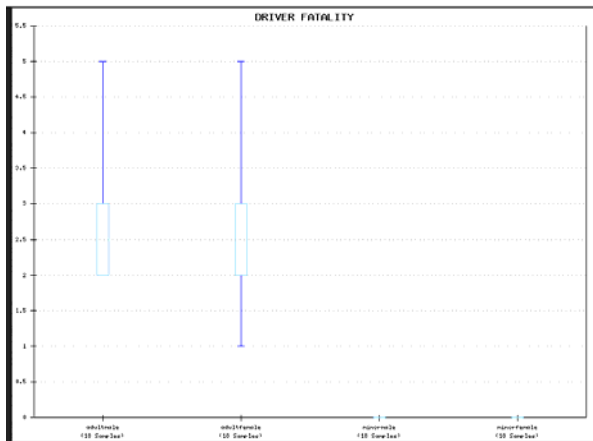

Fig. 12 Driver Fatality Boxplot

From pie charts one can learn quickly get information from the data, which would otherwise take a lot of time spent in perusing through documents. For instance, one can easily tell that vehicles are being driven by minors on Kenyan roads from the Driver Injury pie chart in Fig. 13 and that their numbers are substantial.

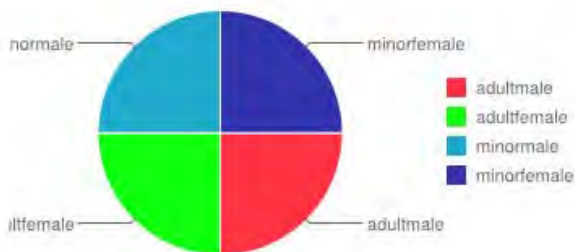

Fig. 13 Driver Injury

Accident reporting has been made easy by making it possible for any person witnessing road traffic accident occurrence to report via the WWW. This is opposed to the current practice where only serious accidents are required by law to be reported and recorded by authorities. This afforded opportunity would lead to a greater number of the accident incidences being reported. Of course the onus lies with the responsible authorities to qualify the authenticity of such reports.

Accident occurrence location (Fig. 13) has been inferred from Google maps based on the textual description accompanying accident statistics. This is still an issue as position determination, in the least, requires mechanical devices with ability to determine position and with some skills

to use such devices for position determination.



Fig. 13 Selected Accident Locations by Date

Accident occurrence location (Fig. 13) has been inferred from Google Maps based on the textual description accompanying accident statistics. It is understood that capacities for position determination may be absent or weak in the key institutions dealing with road traffic accident data. Because such capacities often require years to develop and do have an attendant high equipment cost, alternative approaches are essential in order to address the problem of accurate accident location determination. Thus the researcher suggests that strategies that build off existing trends within society be exploited to fix this challenge. One such trend is the use of smart mobile phones which come packaged with position determining GPS abilities. Smart phone usage is prevalent in Kenya. Thus it may be prudent to train specific people on use of smart phones to collect accident location information.

The researcher is convinced that the AMSYS will enrich the quality of policies and decisions regarding road traffic accidents in the country and that it is now high time to genuinely make use of WebGIS the key concern of the Road Traffic Management Process. Greater effort is, therefore, needed to build coherent strategies, including action plans at national and county levels, to provide incentives for a proactive reporting and to removal of obstacles to data dissemination amongst stakeholders and the society in general.

Data access is a critical factor in determining the ability of such society to press its government and the public as a whole to address emerging problems and their impacts. Therefore, activities that support data collection and dissemination are a key point of action. The researcher recommends that the general public and accident victims in particular to embrace the idea of reporting road traffic accidents to populate the database for ease of access to such data. Further, the stakeholders, in this case the Kenya Police Service, Ministry of Health, Ministry of Transport and Infrastructure, Insurance Companies and Non-Governmental Organizations, to embrace use of this system as information collectors, authenticators and data users for the system to be acceptable.

The system depends heavily on the presence of road traffic accident data and on institutional capacities for authentication.

The continued proper documentation of such data for updating of the system is justified on economic, scientific and social process grounds. Such documentation would result in a considerable amount of readily available structured road traffic spatial and attribute data that can be used in policy formulation and further research. In contrast, the current situation is characterized by various road traffic accident data repositories with varied data access regimes at different acquisition costs. All these result in data access time lags and associated availability uncertainties that make research in this field very unappealing.

All the foregoing are good grounds for discussion, determination and adoption of common standards in data collection. It is suggested that issues to be discussed to further include the standards needed for spatial data representation, application programming interfaces for spatial data processing, semantic issues on what metadata, domain-specific vocabulary are needed for data to be appropriately interpreted and institutional issues such as what agreements, trust, skills, reorganization are necessary for organizations to coordinate effectively in the generation and use of road traffic accident data.

This would be greatly advanced by cooperation between stakeholders as this is critical to the effectiveness of such a system. This would ensure that there is better and more systematic information available for the updating and integrity of AMSYS database. The researcher is of the view that counties develop such systems (where applicable) in conjunction with the national government so that the county systems would in turn feed the national one.

## V. CONCLUSIONS

The AMSYS platform documents the set of procedures necessary to store and query road accident data. Through the developed system, it has been shown that Nairobi County road traffic accident data can be better managed using WebGIS. This can be achieved by replacing the existing patchwork of fragmented individual and uncoordinated efforts by stakeholders with the one-stop system. The system has the ability to stimulate harmonized and synchronized deployment of resources, otherwise disparate, to feed into efforts towards reduction of road accidents on our roads.

This is an achievable exercise that requires minimal financial commitment considering the availability of a wide array of open source tools to implement its operation while its usage does not require specialized training as is the case for GIS programs. The acquisition of data required to populate the system does not entail extraneous efforts and resources as institutions are already in place with clear mandates and responsibilities.

The researcher envisions a situation where after systematic data collection over a number of years, users will be able to make, with confidence from the system, sound and reliable inferences for unbiased policy directions. Researchers will

also have a ready data portal available round-the-clock while the community at large would be informed.

## ACKNOWLEDGEMENT

The author wishes to acknowledge and thank all those organizations and individuals who contributed in any way to the realization of the report, including Dedan Kimathi University of Technology for the learning experience; Research Project Supervisors for their invaluable insights, Kenya National Transport and Safety Authority; Fellow Students in the 2013 GIS and Remote Sensing class; and my family members for their understanding.”

## REFERENCES

- [1] World Health Organization. *Road Safety in the WHO African Region - The Facts* 2013, p. 1. Available at [http://www.who.int/violence\\_injury\\_prevention/road\\_safety\\_status/2013/report/factsheet\\_afro.pdf](http://www.who.int/violence_injury_prevention/road_safety_status/2013/report/factsheet_afro.pdf), on 27 June 2014.
- [2] United Nations Commission for Africa (UNECA). *Road Safety Seminar Outcome Document ECA/NRID/09/012*. pp. 1–6, 2009.
- [3] J. Breen, M. H. Richard, M. Sevara, “Guidelines for Mainstreaming Road Safety in Regional Trade Road Corridors, Sub-Saharan Africa Transport Policy Program (SSATP) working paper; no. 97”, 2013. Available at <http://documents.worldbank.org/curated/en/2013/06/18127874/guidelines-mainstreaming-road-safety-regional-trade-road-corridors>.
- [4] G. C. Manyara, “Combating Road Traffic Accidents in Kenya: A Challenge For An Emerging Economy”. Kenya Scholars and Studies (KESSA) Proceedings, 2013.
- [5] M. A. Bachani, K. Pranali, K. Hadley, S. Mogere, D. Akungah, J. Nyamari, E. Osoro, W. Maina, & A. S. Kent, “Road Traffic Injuries in Kenya: The Health Burden and Risk Factors in Two Districts, Traffic Injury Prevention”, 2012.
- [6] Association for Safe International Road Travel, “Road Crash Statistics”, 2014. Available at <http://www.asirt.org/initiatives/informing-road-users/road-safety-facts/road-crash-statistics.aspx>, ASIRT, on 14th September, 2014.
- [7] T. Sivakumar & R. Krishnaraj, “Road Traffic Accidents Due to Drunken Driving in India – Challenges in Prevention”, 2012. International Journal of Research in Management & Technology (IJRMT). ISSN: 2249-9563, Vol. 2, No. 4.
- [8] C. Baguley, “The Importance of a Road Accident Data System and its Utilization”, pp. 1–2, November, 2001.
- [9] W. Odero, M. Khayesi and P. M. Heda, “Road Traffic Injuries in Kenya: Magnitude, Causes and Status of Intervention”. International Journal of Injury Control and Safety Promotion. Vol. 10, No. 1-2, pp. 53 – 61, 2003.
- [10] M. Ncube, C. L. Lufumpa, S. Kayizzi-Mugerwa & V. Murinde, (2013). “Mortality in Africa: The Share of Road Traffic Fatalities, African Development Bank”, p. 1, 2013. Available at <http://www.afdb.org/fileadmin/uploads/afdb/Documents/Publications/Economic-~.pdf>.
- [11] World Health Organization, “Global Burden of Disease”, 2004.
- [12] United Nations (2010). “Resolution adopted by the General Assembly: 64/255 - Improving global road safety”, Sixty-fourth session, Agenda item 46, 2010.
- [13] Daily Nation Advertisement, “Reforms in the Operation of Public Service Vehicles”, Legal Notice No.161 of 2003, August 4th, 2004.
- [14] Ministry of state for Planning, National Development and Vision 2030, “Sessional paper No. 10 of 2012 On Kenya Vision 2030, 2012”.
- [15] U. M. Shamsi, “GIS Applications for Water, Wastewater, and Stormwater Systems”, p. 3, 2005.
- [16] M. Hirasawa and M. Asano, “Development Of Traffic Accident Analysis System Using Gis”, Proceedings of the Eastern Asia Society for Transportation Studies, Vol.4, October, pp.1193-1199, 2003.
- [17] R. Vigneswari & C. Minachi, “Study on Road Accident Data Management System”, International Journal of Science, Engineering and Technology Research (IJSETR) Volume 2, Issue 11, November 2013, pp. 2057-2062.

- [18] A. Kipngetch, "A Road Traffic Accident Study Using GIS Mapping and Analysis: Case Study of Nakuru – Eldoret Highway", 2011.
- [19] C. Baguley, "The Importance of a Road Accident Data System and its Utilization, p. 6, November, 2001.
- [20] Kenya Police Service, "Accident Black Spots in Kenya" 2014. Available at <http://www.kenyapolice.go.ke/blackspots.asp> on 16<sup>th</sup> July, 2014.
- [21] The National Road Safety Authority, "Accident Statistics", 2014. Available at <http://www.ntsaa.go.ke> viewed on the 7th June, 2014.
- [22] Kenya Roads Board, "Accident Black Spots", 2014 available at <http://www.krb.go.ke/board-members/46-nairobi-province.html> on the 12th February, 2014.
- [23] K. Z. Mwatelah, "Application of Geographic Information Systems (GIS) to Analyze Causes of Road Traffic Accidents (RTAs) – Case Study Kenya" p.5, 2001. Conference Proceedings. International Conference on Spatial Information for Sustainable Development. Accessed at <https://www.fig.net/pub/proceedings/nairobi/mwatelah-TS11-3.pdf> on 21/07/2014.
- [24] World Health Organization, "Road Safety in the WHO African Region - The Facts 2013, p. 1, available at [http://www.who.int/violence\\_injury\\_prevention/road\\_safety\\_status/2013/report/factsheet\\_afro.pdf](http://www.who.int/violence_injury_prevention/road_safety_status/2013/report/factsheet_afro.pdf) on 27 June 2014.
- [25] C. Baguley, "The Importance of a Road Accident Data System and its Utilization, p. 6, November, 2001.
- [26] U. M. Shamsi, "GIS Applications for Water, Wastewater, and Stormwater Systems", pp. 3 - 4, 2005.
- [27] R. A de By, A. K. Richard, S. Yuxian, C. E Martin, K. Menno-Jan, J. C. Michael, G. Yola, M. R. Mostafa, J.Cees , K. Wolfgang & J. S. Edmund, "Principles of Geographic Information Systems", p. 41 , 2001.
- [28] N. Sharma, P. Liviu, F. Raul, I. Abhishek, N. Chaitali, M. Adi-Cristina, M. Mallarswami & D. Mirela, (2010). "Database Fundamentals, 1st Edn", p. 23, 2010.
- [29] World Health Organization & Monash University, "Fatal Injury Surveillance In Mortuaries And Hospitals: A Manual For Practitioners", pp. 38 & 39, 2012.
- [30] J. Luoma & M. Sivak "Characteristics and Availability of Fatal Road-Crash Databases Worldwide", 2006.
- [31] L. Liang, D. Muhamad, & L. Teik HUA, (2005). Traffic Accident Application Using Geographic Information System. Journal of the Eastern Asia Society for Transportation Studies, Vol.6, pp. 3574 – 3589.
- [32] G. S. Agoki, "Characteristics of Road Traffic Accidents In Kenya", 1988.
- [33] E. K. Reshma and S.U. Sharif "Prioritization of Accident Black Spots Using GIS", International Journal of Emerging Technology and Advanced Engineering, Volume 2, Issue 9, 2012.
- [34] M. S. Nabende, "Factors contributing to Bodaboda Taxi Related Traffic Accidents in Kakamega Municipality, Kenya", 1988.
- [35] P. O. Chitere & T. Kibua (2004) "Efforts To Improve Road Safety In Kenya", 2004.
- [36] D. Nyangweso, "GIS Based Evaluation of Road Traffic Accidents Black Spots in Nairobi Area", 2008.
- [37] D. Thuo, "GIS Aided Roads and Traffic Management System – Case Study for Nairobi Central Business District", 2005.

# Environmental Impacts of Artisanal and Small-scale Mining in Taita Taveta County

Seroni Anyona and Bernard K. Rop

**Abstract**—Artisanal and Small-Scale Mining (ASM) often has serious environmental impacts such as physical, chemical and organic pollution of water sources and courses; damage to the landscape which is rarely rehabilitated when the mine closes; deforestation; hunting; and the creation of public health hazards through poor sanitation. ASM can damage an area's viability and compromise the resident community's original or future livelihoods. This paper examines and assesses the impacts of ASM on the natural environment in Taita Taveta County. The county is endowed with a wide variety of highly valued gemstones which, for over forty years, have attracted thousands of artisanal miners; and along with this have emerged adverse environmental consequences. ASM is frequently migratory as miners move from site to site in search of minerals. The rate at which they move, and the area within which they travel, are functions of a combination of practical, economic and social factors including the life of the mine; the lure of high value minerals. There are about 48 forests which have survived on hill-tops in Taita Taveta County of which 28 are gazetted and are under government protection and management. They range in size from small 500 square meters with a few remnant trees to modestly vast 2 square kilometers indigenous and exotic forest mountains. These forests are part of a unique Eastern Arch range of forests which are found mostly in Eastern Tanzania with the Taita Hills forming the only Kenyan Eastern Arc forest type in East Africa. If no action is taken in time these valued ecosystems face extinction. It is important to note that a large portion of this county is occupied by the Tsavo National park. Due to its expanse, there is competition between mining interests and wildlife. This calls for a careful balancing act as mitigation measure against future possible wildlife-human conflicts.

**Keywords:** mineral resources, Artisanal Small-Scale Gemstones Miners, Environmental impacts, Taita Taveta County

## I. INTRODUCTION

Economic growth and environment are closely intertwined in Kenya's development process [1, 2]. Environmental management should consistently be integrated into development planning. Poverty has led to the over-use and destruction of the environment. Continued reliance on minerals extracted from the subsurface like the gemstone, trees for fuel and sand for construction have continued to impact negatively on the environment.

Since independence, Kenya has continued to demonstrate her commitment to environmental management through various

Seroni Anyona, Southern Eastern Kenya University, School of Earth Sciences, SEKU (e-mail: [seroni20@yahoo.com](mailto:seroni20@yahoo.com)).  
Bernard Rop, Mining, Materials & Petroleum Engineering Department, JKUAT (e-mail: [ropben@jkuat.ac.ke](mailto:ropben@jkuat.ac.ke)).

initiatives, among them the National Development Plans of 1974 and the National Environment Action Plan of 1994. Further, there have been a number of sectoral policies on environment in fields such as Agriculture, Livestock, Water, Energy, Food, Land, Wildlife, Forest, Industry, Trade, Arid Lands, Disaster Management and the Draft Sessional Paper No. 6 of 1999 on Environment and Development [3, 4, 5, 6, 7, 11].

The Environmental Management and Coordination Act (EMCA, 1999) provides for the integration of environmental concerns in national policies, plans, programmes and projects. In this regard, EMCA 1999 provides for the formulation of National, County and Sub-county Environment Action Plans every five years [3].

Artisanal and Small Scale Mining (ASM) has been considered illegal for long, yet reality dictates that the poor communities living on mineral rich areas will nonetheless exploit the resources to survive. ASM gemstone mining in Taita Taveta County (TTC) has had negative impacts on the environment. However, regulation and monitoring has not been enforced effectively mainly due to none-recognition of this group of miners and lack of information focusing on this sub-sector. The proposed changes to the mining laws [12] promise positive changes that may provide the legal instruments to improve and promote ASM. This study aims to contribute to the limited body of knowledge concerning ASM in Taita Taveta County in order to assist policy planners and potential investors as well as donors make informed decisions and interventions [9, 10, 11, 12].

## II. GENERAL OVERVIEW

Taita Taveta County is one of Kenya's ASAL regions with 89% of the County area characterized by semi-arid and arid conditions. Only 2.5% of the County (located in the highlands) can be classified as high potential area. The highlands in the County are experiencing high human population pressure and ongoing down-slope migration into the agro-Sahel (semi and lowlands). More than 60% of the County is covered by the Tsavo National Parks; thus further restricting settlements in the lowlands and creating an additional problem, the human-wildlife conflict.

The County can be divided into three major geographical regions, namely: the mountainous zone of the Taita Hills

(Kasigau, Sagalla and Taita Ranges), Taveta at the foot-slopes of Mt. Kilimanjaro, and the lowlands (Tsavo National Parks and rangelands).

The County has two main rainy seasons (bimodal). The long rains occur between the months of March and June while the short rains are from October to December. The mountainous zone serves as rain catchment area with more the 900mm of rainfall per annum [13]. The low-lying areas experience less rainfall. Due to high rainfall and low evaporation, the hills feed rivers and streams running down to the lowlands. Natural mist and secondary forests are typical for the Taita Hills. Taveta and the lowlands are characterized by ASAL vegetation – grasslands, woodlands and shrub lands with Savannah species [14].

#### A. Location, size and administration

Taita Taveta County is one of the seven Counties in the Coast Province. It is situated at latitude between 2°46'N and 4°10'N and a longitude between 37°36'E and 39°14'E. It borders Kwale County to the southeast, Kilifi to the east, Makueni, Kitui and Tana River Countys to the north, Kajiado to the northwest and the Republic of Tanzania to the west/south-west.

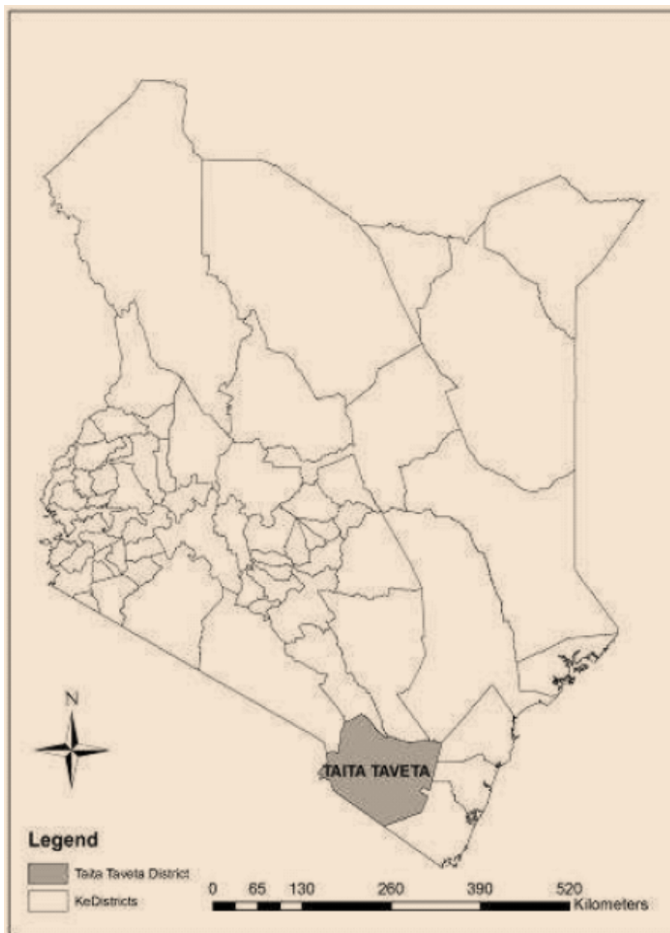

Figure 1: Map showing the Location of Taita Taveta County in Kenya.

In 2007, the then Taita-Taveta County was split into two Countys: the Taita County and the Taveta County. The two

were subsequently merged to form Taita-Taveta County. This consists of four constituencies namely; Voi, Mwatate, Wundanyi and Taveta. There are 20 county wards which include Mwanda/Mgange, Werugha, Wumingu/Kishushe, Wundanyi, Mwatate, Bura, Chawia, Wusi/Kishamba, Sagala, Kaloleni, Kasigau, Ngolia, Mahoo, Bomani, Mboghoni, Ronge, Mbololo, Marungu, Chala, and Mata.

#### B. Population distribution and density

The population of the County 30 years ago was approximately 45,000 persons. According to the 1999 census, the County had a population of 244,945 persons. However, this has shot up to well over 284,657 persons (2009 census) with population densities ranging from 3 persons per km<sup>2</sup> to more than 800 persons per km<sup>2</sup>. The population distribution is varied with most people living in the high potential areas of the foot slopes of the hills and in urban centers.

#### A. Agro-climatic zones / agro-ecological zones

There are three main areas of agro ecological zones (AEZ) that can be distinguished; the high, medium and low potential areas. The highlands belong to the high potential area, the transitional zone to the medium potential area and the lowlands to the low potential area.

Agro ecological zones (AEZ) ranges from the lower highland zone (LH2) and upper midland zone (UM3, UM4) in the Taita hills, down to the lower midland zone (LM4, LM5, LM6) and lowland zone (L5, L6)

Again the high potential (i.e. AEZ 2 and 3), the medium potential (i.e. AEZ 4) and the low potential (i.e. AEZ 5 and 6) can be subdivided into high rainfall and low rainfall sub-zones:

- i) The highest elevations of the Taita Hills belong to the very small lower highland zone (LH2). The main parts of the Taita Hills belong to upper midlands (UM3). The valley bottoms are of higher agricultural potential and are suited for vegetables.
- ii) Steep slopes mainly dominate zones UM4 and LM4
- iii) In the foothill zone, it is too dry to grow maize but some early maturity new sorghum and millet varieties can do better.
- iv) Most of the lowlands belong to LM5, LM6, L5 and L6 and are dry most of the year

#### B. Geology and soils

The Taita hills complex rises above the erosional plains of the lowlands with small inselbergs. Volcanic foothills and lava flows occur in Taveta. Three major blocks constitute the Taita hills – the Sagalla, Taita and Kasigau. The Taita hills are block-faulted basement (crystalline) rocks in the Mozambique belt composed of Precambrian paragneisses from metamorphosed pelitic arenaceous and calcareous sediments from about 290 to 180 million years ago. Technically, the folded lineaments trend N-S and therefore the Taita hills are



related to the evolution of the East African Rift system. They belong to the chain of Block Mountains referred to as the eastern arc mountains. The Taita hills are the northern outliers of the system stretching southward to Pare, Usambara, and Uluguru, Ukaguru, Udzungwa and Mahenge range of mountains in Tanzania. Industrial minerals such as graphite, asbestos, iron ore, gemstones and others are found in the hills and in the surrounding lowlands [15].

Taveta may generally be considered as part of the piedmont plain between the Pare Mountains and Mt. Kilimanjaro. Isolated hills such as Riata, Eldoro, and Salaita rise above the plain. The residuals are directed NNW, parallel to the regional structural trend of the basement system rocks and the Pare mountains as well as the Chyulu range. The area close to the Chyulu range and Mt. Kilimanjaro are covered with quaternary lavas, pyroclastics and debris flow deposits and fluvial and lacustrine volcanic sediments [15, 16]. Some of the lava flows originate from Mt. Kilimanjaro while others erupted from several parasitic cones that are related to the mountains. The rocks are mainly basalts, phonolites and tuffs. Fertile soils developed on volcanic rocks and ashes.

The lowlands are characterized by erosional and sedimentary plains. They are occasionally interrupted by residual hills and inselbergs and pedimental slopes. The extensive plateau gently slopes coast-wards ranging between 1000m and 300m a.s.l. It is underlain by the Precambrian basement system of rocks consisting mainly of crystalline limestones, gneisses and schists. The plateau surface is an erosion surface covered by recent and Pleistocene weathered soil and calcareous crustal deposits.

On Taita Hills, the dominant soils are cambisols. They originate from weathered gneiss and are often gravelly to sandy-loamy and shallow. They are well drained and moderately fertile. Many cambisols are in a transitional stage of development from a young soil to a mature one. On steep slopes and transitional zones the dominant soil types are Regosols, which are shallow soils, have high permeability and low water holding capacity [15]. The drier foothills bordering the hills are characterized by Luvisols, Acrisols and Arenosols soils. They are moderate to low in fertility. In valley bottoms, alluvial soils (fluvisols) are apparently noticed. These are young soils with fertility being moderate to high. They receive fresh sediments and nutrients during regular floods and occur in all larger river basins of Bura, Lumi, Mbololo, Mwatate and Voi Rivers.

Deeply weathered soils are widespread in Taveta sub-County. Saline and sodic soils occur around Lake Jipe while in the western part of the county are soils developed from the basement rock system with some influence of volcanic ashes. The lowlands are characterized by reddish, very deep. Acid

sandy-clayey soil (Ferralsols). They are found in most of the Tsavo National Park and the ranches. They are vulnerable to soil erosion, have a low water holding capacity and low soil fertility [15].

#### *C. Climate and hydrology*

The County has a bimodal rainfall pattern with two rain seasons. The long rains occur between March and May with a maximum in April. The short rains take place between October and December with a peak in November. The rainfall distribution varies depending on elevation and aspect. The annual potential evaporation (E<sub>0</sub>) ranges from 1200 to 2100 mm [13].

Taita Hills receive the highest amount of rainfall. The high potential areas in the Taita Hills (LH2, UM3) receive more than 900 mm of rainfall per annum. (e.g., Wundanyi 1300 mm, Wesu 1400 mm). The temperatures average 15 – 20°C. The medium potential areas receive 700 to 900 mm, with higher temperatures, and evaporation. The Taita hills have a net water surplus. Several rivers drain from the Taita hills (Bura, Kishushe, Mbololo, Mwatate, Paranga and Voi Rivers). The rivers are perennial in their head waters in the highlands but become seasonal in the drier lowlands [13].

The annual average rainfall in Taveta is 350 mm to 750 mm. The temperature ranges between 21 to 38°C and potential annual evaporation is 1950 mm. Taveta has a high ground water table. There are several springs – Salaita, Little Lumi, Njoro Kubwa and Kitobo. Several of the springs and the perennial river Lumi drain into Lake Jipe. Ruvu River springs from Lake Jipe and flows towards Tanzania. Lake Challa and Jipe are the two freshwater lakes in the County and are located right on the border to Tanzania.

The lowlands receive a maximum of between 450 – 750 mm annually and rainfall is more unreliable in amount and distribution. The lower parts are hot with mean temperatures of about 30°C. The potential annual evaporation rate is about 1800 mm. There is therefore a net water deficit. All the rivers flowing through the lowlands are intermittent, with the exception of the Athi, Tsavo and Galana rivers.

#### *D. Land cover*

The Taita Hills used to be covered by montane mist forests whose remnants can still be found on the highest peaks, namely; Mbololo, Ngangao, Chawia and many smaller patches in the Taita ranges and the relicts of natural forests in the Sagalla and Kasigau Ranges. These are the northern most members of the eastern arc mountains globally recognized as one of the biodiversity hotspots.

The flora of these mountains is characterized by a high level of species and generic endemism: the forest ecosystem has more than 2000 species of plants of which 25-30% are endemic. The

Taita Hills forests fauna consists of over 400 species with at least 123 endemic plants. Ngangao and Mbololo forests have 7 of the endemic species. The midland of Taita Hills (<1200M a.s.l.) are drier and are dominated by woodland formation and dry forests of *Acacia* – *Euphorbia* species, *Commiphora* sp., *Ficus* sp. *Tamarindus indica* and *Terminalia brownii* among others.

Taveta-Sub County is covered mainly by an ASAL vegetation, grassland, woodlands and shrubs lands with savanna species (*Acacia* sp, *Commiphora* sp.) where the groundwater table is high, riverine/permanent wetland vegetation types occur with *Acacia xanthophloea*, *Milicia excelsa*, *albizia* sp, *Ficus* sp. etc. (Greenway, Krhoda 1998). The Kitobo forest (about 160ha) is a ground water forest dominated by *Diospyros mespiliformis*, *Albizia*, *glaberrima*, *A. xanthophloea*, *Celtis africana*, *Newtonia buchananii*, *Trichilia emetica*, *Cordyla africana* and *M. excelsa*.

In lowlands, different vegetation occurs. These are woodlands, wooded grasslands, bush lands, grasslands and riverine forests/swamps. Different forms and savannah vegetation are found as influenced by different climatic conditions, animal and human activities. The wettest Savannah environment is represented by the moist savannah or savannah woodland with high trees and grass species (grass cover higher than 150 cm).

The dry savannah (*acacia*, *commiphora*) occupies an intermediate position on the rainfall gradient between the moist savannah and the drier thorn savannah. The grass cover is lower, about 60 – 150 cm and *Acacia*–*Themeda* scattered tree grasslands dominant. The thorn savannah has characteristic grass species of less than 60 cm and with declining rainfall; it is gradually replaced by dwarf shrubs and desert grass communities. Riverine vegetation is found along streams flowing through the dry shrub lands.

### III. ENVIRONMENT AND NATURAL RESOURCES

#### *A. Agriculture*

Horticulture is the largest agriculture based economic activity in the Taita Hills as well as in the irrigation schemes in Taveta sub-County. Among the major horticultural crops are tomatoes, cabbages, kale, onions, carrots, cauliflower, marrows, spinach, Okra, green papers, garden peas, brinjals, leeks, lettuce, chillies, sweet melons, cucumbers, French beans, karella, furia and rianya. Tomatoes and cabbage are the most important horticultural crop in the Taita hills while in Taveta cultivation of tomatoes, onions and bananas is dominant. Perennial horticultural crops include bananas, citrus, avocado, papaya, mango, passion fruits etc. The major industrial crops are sisal, cotton, coffee, coconuts, Macadamia, sunflowers, cashew nuts, groundnuts, Sesame, Jojoba and castor.

Maize and beans are the most important food crops and are mainly grown for subsistence. Other pulses are also grown and are mainly intercropped with maize. Planting of sorghum and millet in the hills is rare, because their acceptance as food crops is low due to their unpopularity as food. Arrowroot and cassava are very important food crops and an alternative when the maize crop fails. Sweet and Irish potatoes are also grown and consumed locally.

The main crop in the lower zones is maize that is often seriously affected by drought. Beans and pulses such as green grams, pigeon peas and cowpeas are widespread. Cassava is also grown to supplement maize. Cotton used to be a cash crop for the lowland communities, but the marketing situation is poor and there is little production. The only large-scale farming is sisal growing. There are two sisal estates remaining, namely Teita and Voi sisal estates. These estates also practice fruit, beef, dairy and vegetable production to diversify and reduce reliance on sisal production alone.

#### *A. Livestock production*

The main livestock products are meat, milk and hides. Dairy production is more common in the upper zone of the Taita hills where the climatic condition and small land holdings are favourable for zero-grazing. The types of dairy cattle found in those areas are Friesian, Ayrshire, Guernsey and Jersey a well as crossbreeds [17]. Dairy production is concentrated in Wundanyi Division, Werugha location and the Bura areas. Most farmers practice zero-grazing. There are approximately 20,000 graded dairy cattle with a milk production of 8 – 12 litres per cow per day while Zebu cattle numbering 11,000 produce on average only 1.5 litres milk per cow.

In Taveta sub-County dairy production is low due to tsetse fly infestation and a natural inclination to horticulture. There is plenty of milk during rainy season from local cattle especially from Maasai livestock, but the production is significant during dry season. Few people practice dairy farming. Goats are kept especially in Njukini area. Goat milk is consumed locally. There is great potential for dairy production in the sub-County due to possibilities of growing fodder but transport of milk is restricted by bad road conditions. Milk production figures for Taveta are given at 9 642 litres per month.

In the lowlands dairy production is low. Zebu breeds are preferred due to their better tolerance of prevailing harsh conditions – climate and diseases. The average milk production is low and milk is consumed locally. In Taita hills there is no beef production because of small farm sizes. In Taveta sub-county, most of the livestock is kept on communal land due to the fact that there are no ranches and more than 2/3 of the land is privately owned. The climate is not very suitable for livestock (hot and dry), so there are only indigenous cows, goats and sheep [17]. Livestock is owned by the Maasai,

Kamba and Taveta tribes and most common cattle breed read is Zebu.

In the lowlands, there are 25 ranches with different systems of organization. The size of the ranches varies between 20,205 and 43 096ha. The ranches are reserved for livestock production through an individual or central herding system. The percentage of livestock kept in the ranches has reduced during recent years due to lack of economic activities, basic infrastructure, harsh climatic and environmental conditions (drought, land degrading etc). Goats are better adapted to such conditions than cattle and sheep. Currently, most of the ranches are operating far below their carrying capacity. As the ranches are under stocked, the Somali community is leasing ranches to graze and fatten cattle that are in transit between North Eastern Province and the market.

There is only one auction ring (Small-scale) for animals in the County, Chumvini market, situated in Njukini location in Taveta sub-County. Middle-men buying cattle from the ranches play an important role in the sale of cattle. Butchers also purchase livestock directly from the ranches. To date the marketing strategies have been poor.

Bee keeping is also practiced. The log hive is most common, where a hollow tree is used with timber lids at both ends. The raw product from the fixed comb hives is called crude honey that is crushed combs, containing honey, wax, pollen and other particles. Other technologies are also famous. These are the modern movable comb hives such as the Kenya to Bar Hive (KTBH) and the langstroth hive. Currently, the amount of honey harvested per year is 7,200 kg from KTBH and 12,000 kg from log hives. The potential of bee keeping has not been fully exploited.

#### *B. Water resources*

The various hills in the County are a source of streams and springs providing water for domestic and livestock consumption.

The county can be divided into four major drainage basins:-

1. Lumi river basin in Taveta division- River Lumi arises from Mt. Kilimanjaro in Tanzania and empties into Lake Jipe and the Ruvu River is a surface outlet of Lake Jipe flowing into Tanzania. There are 2 lakes within the Lumi basin. The Crater Lake Challa and Lake Jipe.
2. Tsavo river basin in Taveta and Wundanyi division- Tsavo River arises from Njukini springs in Taveta Division. It flows into Athi River. Voi river basin in Voi and Wundanyi Divisions- Voi River arises from the Taita hills and flows into Aruba dam in Tsavo East National Park.

3. Mwatate river basin in Mwatate Division- Mwatate river has Bura river as its major tributary and flow southwards through the national park into Kwale County. Voi town is supplied with water from Mzima springs. However, despite rapid population increase and demand, the water supply to Voi has never been improved since the Mzima – Mombasa pipeline was built in 1952. The supply from Mzima springs is not sufficient to meet the demands of Voi town.

Two setbacks affecting mainly the ASAL areas have been the lack of sufficient supplies of water for household consumption and lack of animal watering points. Human Wildlife conflicts are a result of wildlife leaving the parks in search of water during dry seasons.

Some of the private ranches and KWS have established water pans in their respective areas to water livestock and wildlife. Small dams can be found in the County, particularly in the ranches (Mramba and Lualenyi dams) most of the dams contain water the year round and quality is fairly to good.

Taveta sub-county has a high ground water table and substantial water resources due to its proximity to Mt. Kilimanjaro. The rainfall at the slopes of Mt. Kilimanjaro is often heavy and run off is high causing floods which are a menace to roads, bridges and irrigation projects.

#### *C. Status of boreholes and shallow wells in Taita Taveta County*

Table 1: Status of some boreholes in TTC (2004)

Division/ sub district	No. Operational	No. dry	No. saline water	No. abandoned	Total
<i>Bore hole data</i>					
Mwatate	10	12	13	23	58
Taveta	2	1	0	4	7
Voi & Tausa	6	4	2	11	23
Wundanyi	1	0	8	9	18
<i>Shallow wells data</i>					
Mwatate	6	2	0	-	8
Taveta	47	23	2	-	72
Voi & Tausa	10	2	0	-	12
Wundanyi	5	2	0	-	77
Total	68	29	2	-	99

As observed from the table 45% of the boreholes have been abandoned and 16% have dried, while 30% of the shallow wells have dried and one abandoned. It is likely that these ground water sources are drying mainly because mining activities in the area interfere with the ground water table by lowering it and introducing pollutants to the aquifer.

By affecting the hydrological functions all the biological life forms are affected. Special species such as micro biota, benthos, algae, bacteria, fungi, protozoa and invertebrates bear direct consequences.

#### *D. Forestry*

There are different types of forests in the County. The most important of these are the moist forests of the Taita Hills, which belong to the Eastern Arc Forest Mountains of East Africa. The indigenous forest area has been severely reduced due to encroachment for activities, plantation of exotic trees, demand for firewood and agricultural land.

The total area of forest is currently 10,233.62 ha. Statistics on private forests are not available. They consist of exotic tree plantations and bush land but also pockets of indigenous forests. Of the total area, 41.5% are indigenous forests, 12% exotic forests, 1% contains endemic species and 46% are bush land [6, 7, 9].

#### *E. Energy*

The main source of energy is fuel wood (firewood and charcoal). Firewood is predominant in the rural areas while charcoal is common in the urban and pre-urban areas. Other energy sources utilized are electricity, Kerosene and liquefied petroleum gas (LPG). Renewable energy sources (solar, biogas and wind) are not exploited even though the potential of solar and biogas utilization appears to be high. There are three types of fuel wood sources in the County. These are on-farm fuel wood collection, collection from rangelands and forests and purchases from markets.

Over 90% of the rural population use firewood, while the reminder uses charcoal and/or kerosene. Most of the people livings in urban and per-urban centres use a combination of charcoal, kerosene and firewood and a small proportion use gas and electricity. The total demand for fuel wood is estimated at about 41,000 tons per year. The requirement per household is approximately 200 kg firewood, about 2 sacks of charcoal and 20 litres of kerosene per month.

Major energy end-use include cooking, lighting, and milling. In milling, diesel powered engines are used especially where electricity is not supplied. These include posho mills, farm machinery (tractors) and water pumps. Some farmers use animal draught power for ploughing and cart pulling mainly by oxen and / or donkey.

The availability of wood energy can only be sustainable if the annual growth of wood (supply) is greater than the amount being cut (demand). Unfortunately, the Taita hills, formerly covered by dense forests, have been severely deforested to create room for crop production. This has led to a wood energy deficit resulting in Environmental degradation resulting from decreasing tree cover in the high potential areas, Increased use of branches, tree, stumps and roots, agricultural residues (maize cobs ad stems) and animal wastes. Increasing distances walked in search of fuel wood and rising prices of fuel wood.

ASM activities always result in clearance of tree cover. Grounds are cleared to opens space for pits, trenches and shafts. More trees continue to be cut in the course of mining as fuel wood to sustain the large number of miners engaged in the this labor intensive activity. Most mining sites visited during the field study showed evidence of extensive tree clearance such as Mkuki Mining, Timbo Kubwa, Timbo Mlimani etc. The trees found in most of these locations are the indigenous endangered species

#### *F. Wildlife conservation*

Wildlife protection areas form an important land use type Taita Taveta. National Park such as Tsavo East and Tsavo West National Park play an important role in wildlife conservation and promotion of tourism in Kenya.

## IV. STUDY OBJECTIVES AND METHODOLOGY

This study was funded by UNDP in collaboration with the Taita Taveta County government. The broad aim of the study was to get an overview of mining and minerals potential in the county and assess the environmental impacts of the activity in the area.

#### *A. Study methodology*

The study materials and data were gathered between September-October 2014, during an eight-day field period in the county. The empirical materials consisted of RPA (Rapid Rural Appraisal) and in-depth interviews, unstructured interviews, questionnaires and desk references, literature review of existing information, reports, journals and field observations as well as review of relevant Kenyan laws on mining. The field studies began by an excursion as part of the RRA. The interviews were carried out by the team of professionals. The study mainly focused on the areas where mining is taking place. These included Chawia area, Mwatate, Kasigau, Alia, Kishushe, Mkuki, Buguta, Ongoni (Voi River), Bura, Taveta and Wundanyi.

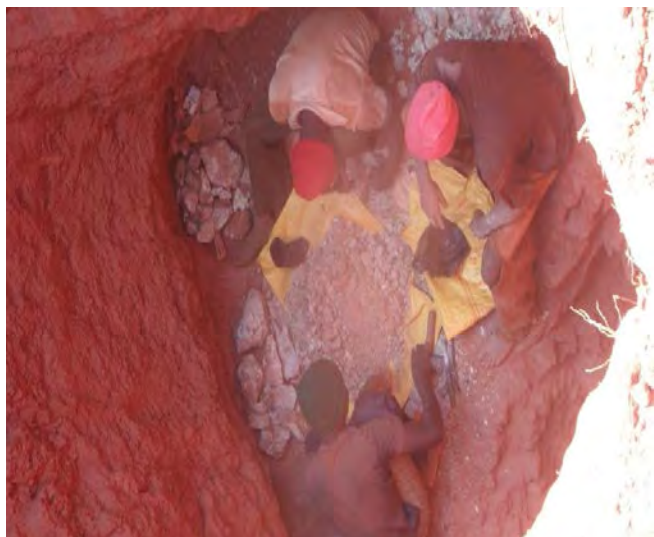

Miners sorting the gemstones

This method emphasizes the importance of genuine participation of the local people, not only for the benefit of researchers but also for the benefit of the locals themselves who were given the opportunity to control, analyze and use the information to determine their destiny. The RRA method is highly recommended by many researchers especially in development cooperation. Information derived from this study was gathered by expert interviews, more unofficial unstructured interviews (representing RRA-approach) and questionnaires, of which the target groups were the administrative officers of Taita Taveta County, established miners and mining companies as well as the local civil society and whistle blowers.

In addition to these interviews, the team held several informal discussions, or unstructured theme interviews of which the most valuable took place with the Taita Taveta County governor H.E Mr Mruttu, some members of the county assembly, mining committee especially the chairman Mr. Mwangola, experienced and long serving miners, brokers and opinion leaders. The Principal of TTUC Prof Boga and Chairman of Mining and Mineral Processing Engineering department TTUC Mr. Ndegwa added value to the study since the institution has been involved in providing solutions to the mining industry. The current government regional geologist, Mr. Omito, provided critical information and guided the research team in field excursions. The team also worked closely with the acting County Executive Committee (CEC) Member in-charge of the Ministry of Mining, Environment, Wildlife and Natural Resources, Ms. Pamela whose input and information regarding the industry was invaluable. The questions were open-ended to elicit broad insights from the respondents on the extractive industry in the county, the activities of their organizations, the challenges faced and their recommendations. The questionnaire used is annexed to this report.

### B. Analysis of the data and materials

The collected information from the questionnaires and interviews as well as the documents received from the key stakeholders were analyzed using standard statistical methods with the aim of presenting an accurate and unbiased assessment of the issues affecting the sampled population.

Critical to this study was also the assessment of the current mining laws, policies and practices and how they impact on the ASM and the extractive industry in general. These were analyzed through SWAP and SWOT. These methods are used to draw conclusions of the study. The SWAP analysis examines the strengths, weaknesses, aims and problems of the content and mining methods and environmental policies and enforcement of the relevant laws in Taita Taveta County.

In total, over 150 artisanal miners were interviewed, 20 local brokers and 10 key small scale miners namely; Musa G. Njagi, Gabriel Mcharo, Miceni Musa, Edith Lewela, Joseph Mtwandei, Major Mtongolo, Jared Nzano, David to mention just a few, were also interviewed in-depth.

### C. StakeholderSs' workshop

After the completion and compilation of this study a stakeholders' workshop was held to disseminate the study findings and receive feedback from the participants. The mining communities were represented by different groups and/or individuals involved in the study.

## V. MINING, QUARRYING AND SAND HARVESTING ACTIVITIES

### A. Economic Geology

The County has different geological resources namely, minerals, rocks and sand. Mining is done in the lowlands, where especially harvesting of gemstone attracts mainly people from outside the County. The Taita community is usually not in the mining business. Mineral processing industries e.g. polishing industries are not located in the county. There is a gemstone market in Rukanga (Kasigau) once a week.

Geological reports of surveys carried out at different times in this region show the presence of mineral deposits in the County and the neighboring areas [15, 16]. A report by Horkel (1980) shows that parts of Taita Taveta County has high and middle value gemstones including: Tsavorite (green garnets), red garnets, ruby, change colour, blue sapphire, pink sapphire, green tourmalines, yellow tourmalines, rhodolites and kyanites. The main gemstone mining area in Kenya is in the Tsavo region, which derived its name from tsavorite [15]. Many small mining operations are located along a fault system extending from the Taita Hills of Kenya to the Uмба Valley in northern Tanzania, passing through the Tsavo, Kasigau and Kuraze areas. This is where Campbell Bridges discovered tsavorite in 1971 and where his company continues to carry

out mining. Taita Taveta County is currently the main source of Tsavorite in the world.

Rubies are associated with ultramafic rocks while *greengrossularites* ("Tsavorite") is strata-bound. Other gemstones include *blue zoisite* ("Tanzanite"), *andradite*, *Red spinel*, *turquoise*, and *Amethyst*. The production of graphite, particularly from the Chawia deposit may also prove economically feasible. Less promising mineralization, mainly with a potential for domestic markets, are magnesite and asbestos occurrences in ultramafic bodies or kaolin and magnetite deposits. The development of bulk commodities such as marble and structural stone depends mainly on an adequate local market potential.

Marble is available for quarrying east of Mwatate on a small scale. Owing to a high Mg (Magnesium) content, the rock is not suited for the manufacturing of cement, but merely for burning to produce lime, and as dimension stone or aggregate. Small quarries for basalt, gneiss and lapilli supply the local requirements for road metal and aggregate. Ample resources of these low-value bulk commodities are readily available for development if required by increased local demand. Building stones (tuffs) are currently being quarried near Taveta town and there is a potential for further expansion if more resources are invested and the demand is right. There is sufficient supply of sand to satisfy the needs of the area and even surplus to sell to the neighbouring counties.

Only private companies e.g. Rock Land Limited, Hardrock Mining Co. Limited, Megalith Co. Limited, Aquamine Co. are successful; due to high levels of funding required for capital expenditure which the ASMs do not have.

The Artisanal and Small Scale Miners do most of the mining covering much of the gemstone belt along fault systems. This group raises much concern with respect to environmental damage.

#### *B. Artisanal and Small Scale Mining*

Most artisanal mining in Taita Taveta is rudimentary in nature; the miners mainly use easily available explosives to break down the rocks in search of gemstones and precious metals. The health and environmental risks are enormous. Besides these issues, the markets for gemstones are not well established – a few dealers and brokers still control the entire process; the small-scale artisanal miners in Taita Taveta have limited market powers. It has been reported that there is a big black market for gemstones. The miners also lack the technical knowhow, capacity, to correctly value the gemstones.

Artisanal mining typically uses manual labour, simple tools, and basic recovery and processing techniques. It is also labour-intensive hence will require a large army of miners to

accomplish what mechanization may accomplish in half the time.

Mining operation of any Ore body can either be underground or surface, and it ranges from manual to mechanized. Gemstone mining also follows this trend, most of it beginning from alluvial deposits on the surface and then advancing underground depending on the mineralization. Alluvial deposits of gemstones were a common occurrence in the early days (60's, 70's, 80's) when the sector was budding with only a few people involved, but with more and more players coming into the picture, it is very rare to find alluvial gemstones these days. Most gem mining is done underground at present with mineralization tending to occur deeper and deeper in the ground as near surface deposits become exhausted.

Mining of these deposits is a tedious undertaking given the effort required to break rock and primarily involves the use of hammers, chisels, shovels and buckets and in some advanced cases drills, compressors, explosives and excavators. Artisanal miners usually apply the most basic of techniques to laboriously dig up box-cuts then tunnels underground as they follow mineralized reefs/zones.

Loose soil normally forms the overburden but this soon turns to hard host rock which requires immense effort to dig through. This is done manually using hammers and chisels, pneumatic rock drills and aided in some cases by prior blasting to loosen the rock. Tunnels dug out in this manner in some instances go more than 50 meters underground, with diameters large enough to allow crawling or crouching as one goes in. Adequate space is, however, provided at the work front to allow for digging and movement of material. Waste rock is usually removed manually using shovels and buckets or sacks but as the tunnel gets deeper, removing waste becomes a tedious task; with most miners preferring to spread it on the tunnel floor or collecting it in one area.



Figure 2: Collecting information from ASMs Mkuki area

#### *C. Environmental impacts of ASM*

Due to the nature of exploration for new mineral resources as mines are exhausted, ASM in Taita Taveta is frequently migratory. It provides labor opportunities for large numbers of

people who live in camps associated with the mines. Over time, these camps disappear or may transform into more permanent settlements, depending on the scale of the resource and the duration of mining activity. This pattern of migratory movement compounded with the unstructured and ad-hoc mining techniques, commonly used by ASMs, and the large number of artisans involved, have profound impacts on the environment. The following environmental impacts were observed in most of the mining sites visited in the county:

1. Tree cutting and bush clearing: A number of indigenous trees and shrubs are cleared to pave way for the mining sites, building residential shelters as well as dumping mine tailings. Such species as the acacia, baobab, etc which take so long to mature are cleared without being replanted. If this trend is not arrested a number of plant species, some of which are rare or endangered, may be lost forever from this ecosystems. Mkuki, Alia and other mines are good examples
2. Removal of top soil and soil erosion: Any extractive method opens the ground and results in the removal of top soil. In most cases, with artisanal miners, this soil is not returned nor stored for re-use. The trenches dug out, the tunnels and clearing of vegetation, initiate soil erosion. During rainy seasons water runs through these openings washing away the valuable soil nutrients. This may also increase the siltation in rivers nearby. This was observed at Mkuki (Mwatate), Timbo-Mlimani(Taveta), Timbo Kubwa (Taveta)and sand mining along Voi river etc.



Figure 3: Disturbed top soil due to mining activities; exposed to erosion

3. Abandoned/disused mines, open pits, tunnels and trenches: Quite often when pits and tunnels are no longer productive or exhausted they are abandoned and never reclaimed nor covered. This poses great danger to both animals and humans. Besides, these openings may create hidings caveats for dangerous

animals or criminals. Rain water may also collect in them creating pools of water for mosquito breeding as well encouraging invasive species to the ecosystem. Surface water may also find its way through these openings and easily penetrate to reach the underground water table thus introducing toxic chemicals and other pollutants. Tunnels and pits also create unstable grounds. Abandoned pits were observed at Wanjiru Baraka Mining One, at Kichungi mines, Gemkit Mining, Kasigau Mining, among others

4. Health implications due to poor hygiene and lack of sanitation: The large number of artisans that normally invade potential or existing mining sites comes along with the basic human consumption habits and waste disposal problems. The need for sanitary services such as toilets, waste dumping sites and general litter has an evident impact on the natural environment. Normally there are no toilet facilities hence bushes and thickets are used instead.
5. Hunting for game meat to provide food for mining camps, sometimes comes with very serious impacts on biodiversity as these mines are in close proximity to Tsavo national parks. Lack of food, reported as one of the key challenges, in most mining sites may compel miners to turn to game meat as an alternative.
6. Physical disruption of the landscape and creation of physical hazards. The change of landscape affects the natural aesthetics of the area.
7. Abandoned plant and machinery – rusty machinery and scrap metals pollute the soil; they create cove for rodents, mosquitoes and even criminals.
8. Sand mining courses river bank erosion and water pollution. This was witnessed along the Voi River at Ongoni area. Sand and gravel degrading along rivers can increase sediments bed load through suspension, hence physically eliminate several organisms and destroy fish spawning and nursery areas, all of which ultimately change aquatic community composition. It can also lower the riverbed, steepen and destabilize riverbanks causing erosion and channel widening (Mathu, and Davies, 1996).
9. Mining activities normally generate a lot of noise, dust, toxic fumes and solid or liquid waste effluent which finds its way into the surroundings causing pollution into the environment



Figure 4: Broken down bull dozer abandoned in the bush

#### D. Open active, abandoned or disused mines

A number of mines in the study area have been abandoned or are in a state of disuse. This is due to a various reasons including; none productivity, owners inability to financially sustain mining, mine is on contested land etc. However there are active mines which remain open and there appears to be no intention to rehabilitate them. These open mines pose major environmental challenges and call for remedial action. Below is a list of some of the open mines identified in the study area and a raft of mitigation recommendations. This is only a limited number of mines which could be visited within the time and resources available. More resources should be invested in carrying out a more detailed study to cover the whole county effectively.



Figure 5: Tunnels cut and left open posing danger to people

Table 2: Locations and mining sites where specific environmental challenges and suggested recommendations

No.	Name of Mine	X Coordinate	Y coordinate	Recommendations
1	Mwatate - Lualenyi	38.304724	-3.528255	Limestone quarry
2	Mgama ridge	38.276848	-3.578411	Can be filled with available material
3	Mgama hill	38.278205	-3.581008	Insufficient material to refill. May be planted
4	Kamton ga	38.37215	-3.643897	Active pit owners need to develop rehabilitation plan
5	Mwariri mba estate – Saulo Mwangola	38.370249	-3.645442	Insufficient material to refill. May be planted
6	Mwairi mba Estate	38.370456	-3.646265	Can be refilled with available materials
7	Mwananchi area Mkungusi	38.366055	-3.707211	Can be refilled with available material
8	Mr. Muchemi	38.366153	-3.707618	Can be filled with available material active
9	Kimotho	38.368248	-3.712303	Insufficient material to refill. May be planted
10	Mwangi's claim	38.370389	-3.716347	Can be filled with available material
11	Daudi's claim	38.297379	-3.62813	Insufficient material to refill. May be planted
12	Mwema's claim	38.377455	-3.71949	Insufficient material to refill. May be planted
13	Mama Fatuma Haji claim	38.390132	-3.74943	Can be filled with available material
14	Hussein Dery Iron Site	38.174987	-3.246712	Inactive mine site
15	Ndononi village	37.688231	-3.336397	Building stone quarry – an EA is needed
16	Kenya – Tanzania Border	37.682391	-3.349309	Building stone quarry – an EA is needed
17	Kenya – Tz small quarry	37.691471	-3.343128	Building stone quarry – an EA is needed



18	Taveta quarry	37.693692	-3.34437	Building stone quarry – an EA is needed
19	Lake Challa quarry	37.707334	-3.33871	Building stone quarry – an EA is needed
20	Shasha Limestone Quarry 1	38.485566	-3.454863	Insufficient material to refill. May be planted
21	Shasha quarry 2 – Nanak Limeworks	38.4961	-3.453982	Has submitted an EA
22	Wanjiru baraka mining	38.423546	-3.781452	Abandoned Mine Disused/Abandoned
23	Aqua Mines	38.512438	-3.87106	Non Active Abandoned Mine- Rehabilitation plan
24	Megalith Mining	3.858953	-3.858953	Non Active Abandoned Mine- Rehabilitation plan needed
25	Kasigau mining	38.716699	-4.213878	Disused/Abandoned- Rehabilitation plan needed
26	Gemkit	38.694716	-4.237542	Disused/Abandoned- Rehabilitation plan needed
27	Kibathi muigai mine	38.694424	-4.147207	Abandoned Mine/Active- Rehabilitation plan needed
28	Kichungu mine	38.695183	-4.237043	Disused/Abandoned- Rehabilitation plan needed
29	Megalith Mining	38.479806	-3.858953	Non Active- Rehabilitation plan needed
30	Waserwa one mining	38.359438	-3.472541	Change color - EIA/EA required
31	Mwang'ondi	38.374104	-3.724098	Green garnet- EIA/EA required
32	Alia mining & Env. Con serv grp	38.277734	-3.582867	Green garnet/ Tourmaline- EIA/EA required
33	Megalith Mining	38.479806	-3.858953	Abandoned Mine
34	Coulsilor	38.722007	-4.180388	Green garnet- EIA/EA required
35	Kasigau mining	38.715028	-4.213274	Green garnet- EIA/EA required

	company			
36	Rubylite	38.696875	-4.153843	Green garnet- EIA/EA required
37	Nadani mine	38.69801	-4.156139	Green garnet- EIA/EA required
38	Mudamu camp	38.722532	-4.17966	Green garnet- EIA/EA required
39	Jerusha mudamu mine site	38.722016	-4.180393	Green garnet- EIA/EA required
40	Tsavo Mining Ltd- mine site	38.562394	-3.889336	Green garnet- EIA/EA required
41	Equator mines	38.508874	-3.863202	Green garnet- EIA/EA required
42	Equator/ Kalinzoi ya Mining	38.510443	-3.871694	Green garnet- EIA/EA required
43	Wajala	38.178874	-3.250428	Iron ore- Has - EIA/EA
44	SPL/507 /547- Patrick Machua	38.686115	-4.155934	Red garnet- EIA/EA required
45	Getonga Mining	38.502943	-3.85806	Ruby-EIA/EA required
46	Rockland Kenya Ltd Ruby	38.497975	-3.859403	Ruby-EIA/EA required
47	Sio Ndoto tena	38.680077	-4.228982	Ruby-EIA/EA required
48	Pit Site- Muthama	38.498075	-3.859859	Ruby-EIA/EA required
49	Equator/ Kalinzoi ya Mining	38.510443	-3.871694	Ruby-EIA/EA required
50	Mbiriri Mines	38.719667	-4.270647	Tourmaline- EIA/EA required
51	Kwa Mwangangi	37.678467	-3.362207	Building stone - Can be filled with available
52	Kidindoni quarry	37.689443	-3.33991	Building stone- Can be filled with available
53	Fort enterprise	38.442518	-3.785395	Green garnet- EIA/EA required
54	Ongoni area-Voi River	38.540000	-3.440000	Sand mining – control excessive mining

VI. CONCLUSION AND RECOMMENDATIONS  
Specific recommendations targeting particular environmental challenges associated with mining have been tabulated below.

Table 3: Overall environmental challenges and recommendations

No.	Environmental Issue related to Mining	Key Issues	Desired Objective	Proposed Interventions	Responsible Institution
1	Deforestation and loss of vegetative cover	<ul style="list-style-type: none"> <li>• Demand for firewood.</li> <li>• Charcoal burning</li> <li>• Forest fires</li> </ul>	Reduce or stop clearance of trees or vegetative cover	<ul style="list-style-type: none"> <li>• Forest patrols</li> <li>• Sensitize miners on conservation</li> <li>• Find alternative sources of energy</li> <li>• Use non-wood materials for camp construction</li> <li>• Create awareness on the importance of indigenous forest</li> <li>• Design environmental friendly mining plan</li> <li>• Encourage Plantation of exotic trees</li> </ul>	Forest Dept K.W.S
2	Water conservation & pollution	<ul style="list-style-type: none"> <li>• Lack of adequate watering points</li> <li>• Water pollution</li> <li>• Over abstraction of</li> </ul>	<ul style="list-style-type: none"> <li>• Stop water pollution</li> <li>• Have sufficient water supply</li> </ul>	<ul style="list-style-type: none"> <li>• Provide adequate water points for</li> <li>• Reafforestation of water catchment</li> </ul>	WRM A, NEM A

		water resources <ul style="list-style-type: none"> <li>• Destruction of water catchment</li> </ul>		areas <ul style="list-style-type: none"> <li>• Enforce water quality regulations</li> <li>• Create awareness on water conservation</li> <li>• Inventory of wetlands and other areas critical to water conservation</li> <li>• Promote rain water harvesting</li> <li>• Refill open pits, trenches and tunnels</li> <li>• Riverbank protection</li> <li>• Protection of the riparian reserves</li> <li>• Mining community sensitization and awareness</li> </ul>	
3	Soil erosion	<ul style="list-style-type: none"> <li>• River siltation</li> <li>• Loss of top soil</li> </ul>	<ul style="list-style-type: none"> <li>• Hills protected</li> <li>• Less siltation of</li> </ul>	<ul style="list-style-type: none"> <li>• Survey of all Hills</li> <li>• Establishment of nurser</li> </ul>	<ul style="list-style-type: none"> <li>• County Authorities</li> <li>• Min. of</li> </ul>

			Rivers • Reduced soil erosion	Trees and Tree planting	Agriculture • Min. of Mining
4	Wildlife Conservation	<ul style="list-style-type: none"> <li>• Human wildlife conflict</li> <li>• Poaching of game</li> <li>• Poor attitude towards wildlife</li> </ul>	<ul style="list-style-type: none"> <li>• To reduce incidences of human Wildlife conflict</li> </ul>	<ul style="list-style-type: none"> <li>• Conduct vigorous animal control</li> <li>• Promote ecotourism and other revenue generating activities</li> <li>• Sensitize miners on the importance of wildlife</li> <li>• Electric fencing KWS patrols</li> </ul>	KWS
5	Illegal Mining & open pits, trenches & tunnels	<ul style="list-style-type: none"> <li>• Abandoned mines</li> <li>• Disturbance of natural landscape</li> </ul>	<ul style="list-style-type: none"> <li>• Rehabilitated abandoned mines</li> <li>• Reduce Illegal and Hazardous mining activities</li> </ul>	<ul style="list-style-type: none"> <li>• Planting of Trees</li> <li>• Refilling of Abandoned and Exhausted</li> <li>• Effective enforcement of EIA requirement</li> </ul>	KWS, County Authorities, Forest Department
6	Abandoned machinery	<ul style="list-style-type: none"> <li>• Metallic waste</li> <li>• Oil,</li> </ul>	<ul style="list-style-type: none"> <li>• Reduced mechanical</li> </ul>	<ul style="list-style-type: none"> <li>• Enforce rigorous</li> </ul>	County authority

		fuel and other mechanical waste	cal and plant waste	inspection of mining sites • Encourage and support scrap metal collectors to clear sites	y, NE MA
7	Poor Sanitation	Human waste management	To Improve liquid waste and effluent management	<ul style="list-style-type: none"> <li>• Ensure proper sanitation in camp sites – use of latrines etc</li> <li>• Have proper solid waste disposal sites - Identify dumping sites</li> </ul>	County government

1. Upon implementation of the new mining Bill, efforts should be made to sensitize and train ASMs on the importance of Environmental conservation and how to develop and write Environmental Impact Assessments (EIAs) for the mining activities. An affordable mode of developing these instruments specific to ASMs should be device to encourage compliance.
2. A substantial number of the mines are abandoned while others are still active. Among the abandoned ones a small number can be rehabilitated using the available earth material dug out. A majority of these will have to be landscaped since they cannot be refilled. Areas where mining is on-going should have an EIA and mine closure plan as is required by law.
3. In order to improve the quality of the implementation of the environment action plan, there is need for the County government to create synergies with the development partners including GEF/SGP COMPACT, NGOs, CBOs and other organizations operating in the county and tap on their comparative advantage..
4. The environmental problems in the county are diverse and will require concerted efforts from all the

stakeholders including the full participation of the mining communities in an attempt to get a sustainable solution. There is need to develop appropriate intervention measures in order to address the prevailing situation and promote environmental conservation in the County.

5. Increase miners' participation in conservation and develop alternative income generating activities such as ecotourism and bee keeping with a view to relieve pressure on land and reduce over dependence on mining
6. Enforce Monitoring and Evaluation:-The purpose of Monitoring and Evaluation of the Environmental Action Plans is to ensure their efficient and effective implementation as well as ensuring that environmental concerns have been addressed and integrated in mining development process. It will involve documentation of "Best Practices" for purposes of replication. The monitoring will be, through consultative meetings and field visits, of all the stakeholders. The information will be contained in quarterly and annual reports.

The following Regulatory instruments may be used

- Environmental Management and Coordination Act, 1999
- Environmental Impact Assessment and Environmental Audit regulations, 2003
- Water Quality Regulations, 2006
- Waste Management Regulations, 2006
- Access and benefit sharing for conservation of biodiversity, 2007

#### REFERENCES

- [1] GOK (2002) Economic survey
- [2] GOK (2004) Economic Recovery Strategy for Wealth and Employment Creation
- [3] NEMA (2003) NEMA State of Environment Reports
- [4] NEMA (2004) NEMA State of Environment Reports
- [5] NEMA (2005) NEMA State of Environment Reports
- [6] GOK (2001) Poverty Reduction Strategy Paper (PRSP) 2001 – 2004
- [7] GOK (2002) County Development Plans 2002-2008
- [8] GOK (2004) Government County Departments Annual Plans
- [9] GOK (2014) Government County Departments Annual Plans
- [10] GOK (1999) Population and Housing Census.
- [11] Kenya: Vision 2030 Government of the Republic of Kenya. Ministry of Planning and national Development. Office of the President, Nairobi, 2007.
- [12] Mining Bill, 17<sup>th</sup> March (2014) Special Issue: Republic of Kenya, Kenya Gazette Supplement No. 28 (National Assembly Bills No 8).
- [13] Voi Meteorological Department's Annual Internal Reports (2013).
- [14] NEMA (2013) NEMA State of Environment Reports.
- [15] Pohl W. and Horkel, A (1980) Notes on the Geology and Mineral Resources of the Mtito Andei-Taita Area (Southern Kenya), Kenya Austria Mineral Exploration Project.
- [16] Bridges, C.R. (1974) Green grossularite garnets (tsavorite) in East Taita Taveta County (TTC). *Gems & Gemology*, Summer, pp. 290–295. Scale mining and sustainable development within the SADC Region.
- [17] Livestock and Fisheries Departments Annual Internal Reports (2008).

# Determination of the Thermo-physical Properties of Walling Materials for Thermal Comfort in the Sub-Tropic Highland Climate, Kenya

R. N. Kariuki, B. N. Mugwima and J. W. Kaluli

**Abstract**—People in modern society spend about 90% of their time indoors. The requirement of sustainable (or green) building includes the necessity to create healthy and comfortable indoors such as satisfaction with the thermal environment. The thermo-physical properties of materials used in construction of the building envelop, such as the walls, will affect this indoor thermal environment depending on the external weather conditions. Nairobi's outdoor temperatures of 10°C to 26°C mostly fall out of the optimal range of 20°C to 23°C that will minimize the need for indoor temperature adjustment. Yet in Kenya the applicable regulation regarding walls in buildings does not set any requirement regarding thermal performance. The international trend is to specify the thermo-physical properties (usually the thermal transmittance (U-value), and thermal mass) in the regulation of the building elements. There is therefore need for development of a design criterion for specifying building materials for thermal performance to guide architects and engineers in material specifications. This paper is a review of existing literature on the relationship between thermal comfort and building materials. It forms a background for studies to collect data that will form a basis for regulation and assessment of the suitability of building materials developed in or imported into Kenya.

**Keywords**— Walling, thermal comfort, sub-tropic climate, thermal transmittance, thermal mass.

## I. INTRODUCTION

**B**UILDINGS accommodate people, provide security, privacy and protect them from the weather elements. In modern society people spend about 90% of their time indoors [1]. The requirement of sustainable (or green) building includes the necessity to create healthy and comfortable indoors including satisfaction with the thermal environment [2]. That condition of mind, which expresses satisfaction with the thermal environment, is the thermal comfort [3].

The thermo-physical properties of materials used in construction of the building envelop, such as the walls, will affect the indoor thermal comfort. Heat, from solar radiation,

flows by conduction through various building elements such as walls, roof and floors as well as by convection and radiation at the surfaces. Part of the heat energy is stored in the building fabric.

In selecting building materials designers have a wide range to choose from in order to, among other requirements, achieve thermal comfort in buildings. The main properties of the construction elements that determine the rate of the heat exchange are thermal transmittance (U-value) and thermal mass. Materials may be lightweight with low thermal transmittance for insulation or dense with high thermal mass for collecting, storing solar heat and releasing it when needed especially at night.

In Nairobi, Kenya, where the mean temperatures range from 10oC to 26oC, the most common materials used for walls have very different thermal properties. Natural stone and earth which account for about 57% of materials for walls have high U-values and high thermal mass while galvanized iron sheets which account for about 27% have high U-values and low thermal mass. On the other hand prefabricated insulated walling panels which are being introduced into the country have low U- values and low thermal mass. Studies on residential buildings in Yemen, Turkey, Chile and Kenya [4-7] suggest that walls of high thermal mass using local materials are better at moderating diurnal temperature variations compared to those of more modern low thermal mass and insulating materials.

The relationship between thermal properties of building materials and thermal comfort forms a basis for building regulations. The regulations in the United Kingdom and Japan specify maximum thermal U-values for walls [8]. In South Africa, the standards incorporate both the thermal capacity and thermal transmittance of materials for walling [9]. In Kenya, building materials for design and construction of building walls are regulated by the Local Government (Adoptive By-Laws) Building Order (1968) and specify minimum thicknesses of selected materials for structural stability and not for indoor thermal environment.

The international trend is to specify the thermo-physical properties (usually the thermal transmittance (U-value), and thermal mass in the regulation) of the building elements. There

Kariuki, R. N., Nairobi Institute of Technology (P.O. Box 66443-00800, Nairobi )

Mugwima B. N., Department of Architecture, JKUAT (P.O Box 62000-00200).

Wambua Kaluli, Department of Biomechanical and Environmental Engineering, JKUAT (P. O Box 62000-00200, email: wambuak@gmail.com

is therefore need for development of a design criterion for specifying building materials for thermal performance to guide architects and engineers in material specifications. This paper is a review of existing literature on the relationship between thermal comfort and building materials. It forms a background for studies to collect data that will form a basis for regulations and assessment of the suitability of building materials developed in or imported into Kenya.

## II. BUILDING FOR THERMAL COMFORT

Thermal comfort is defined as "that condition of mind which expresses satisfaction with the thermal environment" [3], and is dependent on environmental variables: air temperature, mean radiant temperature, humidity, air velocity and personal variables such as clothing and metabolic rate. It has been shown that in certain seasons, man's physical strength and mental activities are at their best within a given range of climatic conditions, and outside this range efficiency lessens, while stresses and the possibility of diseases increase. Temperatures outside comfort range have been associated with respiratory diseases [10], emotional stress and low productivity [11] and mortality [12].

A necessary condition for thermal comfort is a balance between the metabolic heat production and the heat loss from the body to the environment. In order to stay healthy, the internal body temperature must be kept at 37°C and heat produced must be balanced by the heat lost from the body [13].

The environmental factors for thermal comfort may be achieved by passive design through the implementation of features in buildings to work with natural processes rather than by artificial heating and ventilation [14]. This involves the selection of construction materials with appropriate thermal properties. Passively designed buildings are naturally conditioned and run with a minimum of energy input for thermal comfort. Energy efficiency is an important feature in making a building material environmentally sustainable. The goal of using energy-efficient materials is to reduce the cost of air conditioning and hence reduce the long-term energy costs of operating a building. A rammed earth house constructed for passive heating and cooling was found to result in an energy saving of 50% compared to that of other conventional houses in Southern Australia [15].

The energy performance in buildings may be modelled using mechanistic (white box), black box or grey box models. Mechanistic models are developed based on "white box" or physical methods which employ heat transfer equations based on detailed description of the building geometry and thermal properties. "Black box" models use mainly statistical data collected over an exhaustive period of time. The "grey box" model is a hybrid of the white box and black box and uses basic prior knowledge of the building characteristics combined with a reasonable amount of measured data to estimate the missing physical parameters to describe the building thermal performance. Based on the "white box" model, it is possible to

use computer simulation programs like Energy Plus, TRNSYS, and Fluent which have been developed to predict the indoor thermal environment and energy requirement. The input data for such programs is the building geometric data, climatic data and the building material properties [16].

## III. THERMAL COMFORT IN THE SUBTROPIC HIGHLAND KENYA

In naturally conditioned buildings it has been found that the temperature which occupants will find acceptable is linearly related to the monthly mean of the outdoor temperature. Humphreys and Nicol developed a formula for predicting comfortable temperatures [17] by examining outdoor mean temperatures:

$$T_c = 13.5 + 0.54T_o \quad (1)$$

Where  $T_c$  is the comfortable indoor temperature and  $T_o$  is the monthly mean outdoor air temperature. This is the basis for the ASHRAE Standard 55 [18] where the comfort zone is  $T_c \pm 3.5^\circ\text{C}$  for 80% acceptability limits.

For Nairobi, Kenya, in the sub-tropic highland climatic zone, the mean monthly temperature ranges from 15.5°C to 19.0°C. In May, for example, the mean monthly temperature is 18°C and therefore the expected comfortable indoor temperature is between 19.7°C and 26.7°C. The lower mean values of temperature (Mean Minimum of 13°C in May) suggest that it is necessary to raise indoor temperatures for a significant period of the day in Nairobi to achieve thermal comfort (Fig. 1).

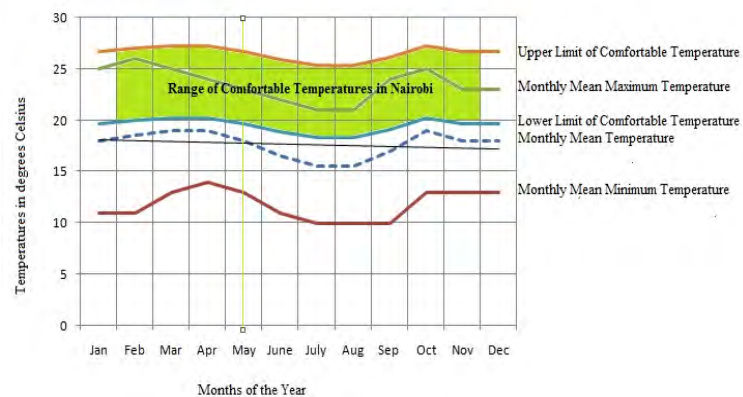

Fig. 1 Range of Comfortable Indoor Temperature for Nairobi from (1) Source: Temperature data from Kenya Meteorological Service

## IV. THERMO-PHYSICAL BEHAVIOR OF BUILDING MATERIALS

The primary parameters that determine heat transfer of a material are its density, specific heat capacity, and thermal conductivity. Thermal conductivity is the property of a material to conduct heat by transfer of internal energy through microscopic diffusion and collisions of particles (molecules, electrons and atoms) within a body. Fourier's Law of Heat

Conduction states that the time rate of heat transfer through a material is proportional to the negative gradient in the temperature and to the area, at right angles to that gradient, through which the heat flows. The specific heat capacity is the amount of heat per unit mass required to raise the temperature of the material by one degree, a measure of ability to store heat energy in the form of vibrations of atoms of the material [19].

In building elements, thermal transmittance (or U-value) is used to measure the rate of transfer of heat through one square metre of a structure divided by the difference in temperature across the structure expressed in  $W/m^2K$ . U-value takes into account heat transfer due to thermal conduction, thermal radiation and thermal convection. For a building element like the wall, the U value of the element is calculated as follows:

$$U = 1 / (R_{so} + R_{si} + R_1 + R_2 + \dots) \quad (2)$$

Where

$R_{so}$  is the fixed external resistance;  $R_{si}$  is the fixed internal resistance and  $R_1+R_2\dots$  is the sum of all the resistances of the building materials in the constructional element.

Thermal mass in  $J/m^2K$  measures the amount of heat stored in the building fabric which is later released to control temperature fluctuations. It takes into account specific heat capacity, density and thickness of the material layers forming the element. For a building element like the wall, the thermal mass of the element  $K$  is calculated as follows:

$$K = c_1 \cdot \rho_1 \cdot d_1 + c_2 \cdot \rho_2 \cdot d_2 + c_3 \cdot \rho_3 \cdot d_3 + \dots \quad (3)$$

where:

$c$  is specific heat capacity of layer ( $J/kg \cdot K$ ),  $\rho$  is density of layer ( $kg/m^3$ ) and  $d$  is the thickness of layer (m)

The mechanism of heat transfer in buildings begins during the day, when the external wall temperature increases as a result of the incident solar radiation. As the time passes, some of the heat is absorbed by the wall and the temperature increases according to the material's thermal capacity. The heat moves through the wall, towards the inside surface. During the night, a reverse process takes place, as the temperature outside decreases and there is no solar radiation. In this regard, two types of materials are identified: thermal insulators with low thermal transmittance and thermal mass which store incoming energy and later release this energy as heat [20].

The heat transfer processes of convection, conduction, radiation, heat storage and release results in a complex relationship between the outdoor and indoor temperatures in naturally ventilated buildings. As the outdoor air temperature and solar radiation intensity change significantly during day and night, the indoor air temperature also varies with time. The periodic sinusoidal relationship between these external and indoor variations is expressed as the decrement factor and the time lag of the building element. Time lag is the time difference between the temperatures maximum at the outside

and inside when subjected to periodic conditions of heat flow. The decrement factor is the ratio of the maximum outside and inside surface temperature. The time lag and decrement factors are dependent on material's density, thermal capacity, thermal conductivity, surface resistance and the time cycle of the temperature variation [21].

Recent studies of thermal performance of the different walling materials around the world seem to suggest better performance by materials of high thermal mass. In hot dry Sanaa, Yemen [4] demonstrated that indigenous building materials in Yemen (mud brick and fired bricks) perform better than contemporary materials (stone and concrete) in reducing temperature fluctuations within buildings in the critical very cold temperatures between November and March. In warm dry-summer continental climate in Yozgat, Turkey [5] suggests that walls with high thermal mass such as stone and soil blocks have a better moderating effect on temperature swings compared to low thermal capacity and high insulation materials such as the structural insulated panels and timber frame. Palme, Guerra & Alfaro in San Pedro De Atacama, Chile concluded that earth construction performed better than concrete blocks and timber in guaranteeing internal thermal stability and comfort [6]. However, other workers have found insignificant differences in performance of mud bricks, insulated panels and fired clay brick in humid subtropical climate of Sydney, Australia.

#### V. THERMO-PHYSICAL PROPERTIES OF WALLING MATERIALS IN NAIROBI, KENYA

In Nairobi, Kenya a wide range of materials for walling are available. The most commonly used are stone (47.4%), galvanized corrugated sheets (26.9%), Bricks/blocks of concrete and clay (14.0%), mud (9.1%) and wood (1.9%) [22]. In addition, structural insulated prefabricated panels consisting of two outer layers of structural facing material of concrete or compressed fibres separated by an insulated core of polymer foam of polystyrene are being promoted in the country for energy saving and faster construction.

With all these materials having different thermal transmittance and thermal mass values (Table1) it is expected that they will result in different internal temperature values throughout a 24 hour period depending on the external thermal conditions

TABLE I  
U-VAUES AND THERMAL MASS VALUES FOR TYPICAL WALLING CONSTRUCTION IN  
NAIROBI, KENYA

	Wall Type	U-Value (W/m <sup>2</sup> K)	Thermal Mass (J/m <sup>2</sup> K)
1	200 mm natural stone masonry plastered on one side	2.86	367,800
2	Galvanized corrugated iron sheets with ex 75 x 50mm frame	3.34	10,300
3	200 mm lightweight concrete blocks plastered on both sides	0.81	135,600
4	300mm thick rammed earth stabilized with cement and plastered on both sides	2.08	547,800
5	Timber frame with ex 25mm thick cypress, ex 75 x 50mm frame and 9mm gypsum board interior lining	1.66	22,700
6	150mm structural insulated panel consisting of 80 mm expanded polystyrene and 35mm plaster on both sides	0.34	93,800
7	150mm Fiber reinforced calcium silicon board with fiber and cement reinforced EPS	0.20	11700

A study in Nairobi in which closed test chambers were used to assess the effect of thermal mass of materials on indoor temperature concluded that high thermal capacity materials (stone wall with concrete roof tiles) were more effective in moderating extreme temperatures compared to timber wall with galvanized iron roofing sheets [7]. The study was limited in number of materials studied and could not take into account the effects of natural ventilation that occurs in actual buildings.

#### VI. BUILDING REGULATIONS FOR THERMAL PERFORMANCE

The requirement for thermal comfort and the relationship with properties of construction materials forms a basis for building thermal regulations in the different climatic zones around the world. These regulations reflect the nature of the climatic conditions with lower transmittance values for colder climates. In the United Kingdom the Building Regulations (2010) specifies maximum thermal transmittance values (U-values) of 0.25 W/m<sup>2</sup>K. In Japan, the Design and Construction Guidelines on the Rationalisation of Energy Use for Homes are set for residential buildings for six different climatic regions ranging from 0.35 W/m<sup>2</sup>K to 0.53 W/m<sup>2</sup>K for walls [23].

In the United States, the International Energy Conservation Code 2004 [25] was devised by the International Code Council and sets rules for residential (with less than 4 floors) and for small and simple commercial buildings for eight climatic zones [24]. Unlike other cited regulations, the IECC distinguishes between light weight walls from massive walls in setting U-values. These values range from 0.32-0.47 W/m<sup>2</sup>K for wood frame walls and 0.32-1.12 W/m<sup>2</sup>K for massive walls. The South African National Standard for Energy Efficiency in

Buildings [9] uses a CR-value which is an arithmetic product of the thermal capacity and thermal resistance value in hours. Thermal resistance is the reciprocal of thermal transmittance. For residential house, the standard sets the minimum CR-value between 80-100 hours depending on the climatic zone. The higher the CR-value the greater is the ability of the wall to moderate and minimize effect of external climate conditions in building interiors.

In Kenya, building materials for design and construction of building walling are regulated by the Local Government (Adoptive By-Laws) Building Order (1968) and specify in the Third Schedule the minimum thicknesses of only stone, concrete or fired clay blocks and bricks as 8 1/2”(216mm) for walls not exceeding 12 feet (3660mm) in height. This regulation is concerned with structural stability rather control of internal thermal conditions and is therefore inadequate to guide architects and engineers, regulate the building industry or assess suitability of materials regarding provision of comfortable indoor thermal environment in this country.

#### VII. CONCLUSIONS AND RECOMMENDATIONS

The thermal comfort standards suggest that for the outdoor temperature in Nairobi, indoor temperatures in buildings require adjustment for a healthy and comfortable environment. Passive design measures such as selection of building materials with appropriate thermal properties should enable an increase in indoor temperatures compared to outdoor temperatures in the colder hours of the day.

Given the range of local and imported materials available which have significant differences in thermo-physical properties, studies are required for determining which of these properties are desirable for this climatic zone. Such a study



will provide design criteria for the selection and specifications of materials by architects and engineers. The data collected may be used for development of building regulations, which are currently inadequate, regarding materials for thermal comfort. It will also determine the required thermo-physical properties of building materials to be imported into Kenya and to form a basis for research in materials that are appropriate locally for a comfortable, healthy and energy saving indoor environment.

#### REFERENCES

- [1] Leech J A, Nelson W C, Burnett R T, Aaron S, Raizenne M E (2002) It's About Time: A Comparison of Canadian and American Time-Activity Patterns. *Journal of Exposure Analysis and Environmental Epidemiology* 12:427-32
- [2] Halliday, S. (2008) *Sustainable Construction*, Sydney, Butterworth-Heinemann
- [3] ISO 7730 (2006) Moderate thermal environments- determination of the PMV and PPD indices and specification of the condition for thermal comfort. ISO, Geneva
- [4] Alhaddad, M. A and Jun, Z.T., (2013). A Comparative Study of the Thermal Comfort of Different Building Materials In Sana'a. *American Journal of Engineering and Applied Sciences*, 6 (1): 20-24, 2013 Science Publication
- [5] Elias-Ozkan, S.T, Summers, F, Surmeli, Nand Yannis S., (2006). Comparative Study of the Thermal Performance of Building Materials. The 23rd Conference on Passive and Low Energy Architecture, Geneva, Switzerland, 6-8 September 2006.
- [6] Palme, M., Guerra, J. & Alfaro, S (2014) Thermal Performance of Traditional and New Concept Houses in the Ancient Village of San Pedro De Atacama and Surroundings. *Sustainability* 2014, 6, 3321-3337
- [7] Ogoli, D.M (2003) Predicting indoor temperatures in closed buildings with high thermal mass. *Energy and Buildings* 35 (2003) 851-862
- [8] The Building Regulations 2010 (2010) Conservation of Fuel and Power Retrieved 11 November 2014 from [http://www.planningportal.gov.uk/uploads/br/BR\\_PDF\\_AD1B\\_2010.pdf](http://www.planningportal.gov.uk/uploads/br/BR_PDF_AD1B_2010.pdf)
- [9] SANS 204 (2011) South African National Standard: Energy efficiency in buildings. Retrieved 11 November 2014 from <http://www.psee.org.za/portals/0/downloads/za.sans.204.2011.pdf>
- [10] Mourtzoukou, E. G. and Falagas, M. E. (2007) Exposure to cold and respiratory tract infections. *The International Journal of Tuberculosis and Lung Disease*, Volume 11, Number 9, September 2007, pp. 938-943(6)
- [11] Barnston, A.G. (1988). The effect of weather on mood, productivity, and frequency of emotional crisis in a temperate continental climate. *International Journal of Biometeorology* 1988, Volume 32, Issue 2, pp 134-143
- [12] Ye, Y., Zulu, E., Mutisya, M., Orindi, B., Emina, J and Kyobutungi, C. (2009) Seasonal Pattern of Pneumonia Mortality among Under-Five Children in Nairobi's Informal Settlements. *American Journal of Tropical Medicine and Hygiene*. November 2009 vol. 81 no. 5 770-775
- [13] Humphreys, M. (1995) Thermal Comfort Temperatures and the Habits of Hobbits.
- [14] Beggs, C. (2007) Passive solar and low energy building design. *Energy Management and Conservation*, 243-270
- [15] Soebarto, V (2009), Analysis of indoor performance of houses using rammed earth walls. Eleventh International IBPSA Conference Glasgow, Scotland July 27-30, 2009
- [16] Perera, D.W.U., Pfeiffer, C. F., Skeie, N.O. (2014). Control of temperature and energy consumption in buildings - A review. *International Journal of Energy and Environment*. Volume 5, Issue 4, 2014 pp.471-484
- [17] Humphreys, M.; Nicol, J. (2002) Adaptive thermal comfort and sustainable thermal standards for buildings. *Energy and Building*, 2002, 34, 563-572
- [18] ASHRAE Standard 55 (2010). Thermal Environmental Conditions for Human Occupancy. Atlanta: ASHRAE Inc.
- [19] Venkanna, B.K. (2010). *Fundamentals of Heat and Mass Transfer*. New Delhi: PHI Learning.
- [20] Givoni, B. (1991) Characteristics, design implications, and applicability of passive solar heating systems for buildings *Solar Energy*, 47, 425-435.
- [21] CIBSE Guide A3 (2006) *Environmental Design*. London: CIBSE
- [22] Kenya Open Data (2014). 2009 Census Volume II Table 6: Households by main type of Wall Material for the main dwelling unit, county estimates. Retrieved 26 November 2014 from <https://www.opendata.go.ke/Poverty/2009-Census-Volume-II-Table-6-Households-by-main-t/2mf4-9b4s>
- [23] IEA, 2008. Law Concerning the Rational Use of Energy (2005 Revised Energy Conservation Law), December 2008.
- [24] International Energy Agency (2008) Energy Efficiency Requirements In Building Codes, Energy Efficiency Policies For New Buildings, OECD/IEA, March 2008
- [25] IECC 2004, International Energy Conservation Code 2004. Energy standard for Low-Rise Residential Buildings set by the International Code Council, ICC

# Influence of Waste Lubrication Oil Combustion on Emissions

B. O. Owiti<sup>1\*</sup>, H. M. Ndiritu<sup>1</sup> and B. B. Gathitu<sup>2</sup>

**Abstract**—Rising Energy prices across many regions have led to major shifts in energy supply sources and the overall trade balances. Fossil fuel faces the danger of being depleted and at the same time it degrades the environment. Fluctuating oil prices also increases the cost of running power plants that are based on fossil fuels. Global environmental protection requirements coupled with concern for long-term and sustainable energy supply necessitates exploration and exploitation of alternative fuel sources to supplement and avoid overreliance on already existing sources. Waste lubrication oil is one such source. It is a major output from lubrication process in transportation, industries and power generation sectors among others. With further industrialization and population growth especially the middle class, the amount of waste lubrication oil is set to increase significantly thereby making it a potential source of energy for process heating. There is also a need to establish safe mechanisms of recycling and utilizing this waste oil to protect the environment from disposal pollution problems. Waste lubrication oil can be burnt under flow regulations using waste oil burner to minimize combustion emissions.

**Keywords**—waste lubrication oil, power generation, combustion emission, disposal.

## I. INTRODUCTION

**M**AJOR problems associated with energy supply for industrial development include: climate change, pollution and energy insecurity. To be able to address these problems, huge changes in energy infrastructure must be made [1]. Hydroelectricity is the main form of renewable source of energy worldwide. In Africa, it is recorded that effects of climate change affect severely Hydroelectric Power (HEP) plants more so in areas of low annual rainfall. Climate change results in increasingly unpredictable weather patterns making HEP plants ineffective and unreliable due to reduced dam reservoir inflows to non-sustainable levels during dry seasons [2]. In Kenya, energy deficit is experienced in form of frequent power rationing and outages. HEP highly relied on as the main renewable energy source in the country decreases in output annually due to constantly reducing rainfall and droughts. Kenya's hydropower base contributes about 55% of national energy requirements. This contribution is endangered by rainfall decline and therefore the nation may be forced to explore other energy sources to sustain its industrial operations. Masinga dam, one of the Seven Forks dams, has its HEP output decreasing yearly due to decline in average dam water level at the rate of 0.58 m

annually [2]. It is expected that global energy demand will double by the year 2050 even with some improvements in energy efficiency realized. This is inevitable due to expected global population growth, global economic growth, continued urbanization and increased demand on mobility and other energy dependent services. World energy demand is growing much faster than expected leading to a widening gap between supply and demand for electric energy [3]. Depletion, increasing demand and price of petroleum prompted extensive research worldwide on alternative energy sources for internal combustion engines and other combustion processes [4]. This therefore, calls for the need to diversify energy generation by utilizing more of the existing sources as well as exploring new energy sources. Waste Lubrication Oil (WLO) has quite high energy content but is very much underutilized especially in the area of power generation. It originates from various sources like automotive sector, hydraulic systems, rail locomotives, industrial sector, turbines, and transformers among others [5]. One major and significant characteristic of WLO is that it contains both chemical and physical impurities and as such requires re-refining to enable its recycling and/or reuse [6] - [7]. Kenya's economy is actively driven by energy from wood fuel, petroleum and electricity excluding solar energy which is widely used for drying purposes [8].

There have been increased efforts to reduce overreliance on petroleum fuel for energy generation and in transportation and attention is shifting to alternative fuels [9]. A lot of energy goes untapped from WLO when it is thrown away as a means of disposal as is the practice in many areas. Conventional methods of disposing off WLO are very hazardous and quite harmful to both land and water bodies. Arumugam, Veeraraja and Esakkimuthu [10] propose waste oils from automobiles, industries and cooking as energy source to supplement energy demand due to their high heat values. If proper measures and regulations regarding combustion of WLO are observed then WLO can be a major source of energy. Combustion emissions of a WLO burner are determined by the burner operating conditions these emissions are mainly carbon monoxide (CO) and carbon dioxide (CO<sub>2</sub>), unburnt hydrocarbon (UHC) and oxides of nitrogen (NO<sub>x</sub>) i.e. NO and NO<sub>2</sub>.

This paper presents effects of varying combustion reactants flow rates (fuel and oxidizing air) on combustion emissions (CO and UHC) and CO<sub>2</sub>.

B. O. Owiti, Department of Mechanical Engineering, JKUAT (phone: +254 727 146 149; e-mail: bowiti@jkuat.ac.ke).

H. M. Ndiritu, Department of Mechanical Engineering, JKUAT (e-mail: hndiritu@eng.jkuat.ac.ke).

B. B. Gathitu, Department of Chemical Engineering, TUK (e-mail: bbgathitu@gmail.com).

### A. Carbon Monoxide and Carbon Dioxide

When a complete combustion process occurs, the normal products of combustion that result are CO<sub>2</sub> and water vapour. An incomplete combustion will result into formation of CO and other unburnt fuel particles as combustion emissions. CO emissions are more likely to result during rich mixture conditions. It is an intermediate species formed from reaction of oxygen atom with carbon in the fuel. First, oxygen molecule is broken into oxygen atoms with the help of an energetic third body, M. These atoms then combine with carbon to form CO as illustrated in Equations 1 and 2 below.



If sufficient oxygen (O<sub>2</sub>) required for complete combustion of a given fuel is present then CO will be completely oxidized to CO<sub>2</sub> [11]. This is illustrated using Equation 3.



### B. Unburnt Hydrocarbon (UHC)

During combustion UHC result due to many reasons. Fuel rich mixtures is one of the reasons for UHC emission. This means less O<sub>2</sub> is available for for complete fuel oxidation and as such some of the fuel will leave the combustion chamber unburnt. In regions of the flame near the combustion chamber surfaces heat lost through the chamber walls is greater than the heat required to sustain the flame. This condition causes areas of quenched flame where hydrocarbons are left unburnt. Also in many cases combustion chamber contain gaps and cervices that hinder flame propagation. UHC usually build up in these areas. Reduced combustion speeds always leads to incomplete combustion. This occurs because the combustion velocity at this condition is too slow to allow the whole combustion charge to completely burn before it is expelled through the exhaust pipe to the environment. UHC emission can be regulated through lean fuel oxidizer mixture conditions as well as extended residence time in the combustion chamber at high temperatures [11].

### C. Oxides of Nitrogen (NOx)

Oxides of nitrogen are usually formed at high temperatures when nitrogen (N<sub>2</sub>) is oxidized in air. This reaction is normally governed by the Zeldovich mechanism as illustrated in Equations 4, 5 and 6 below:

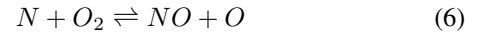
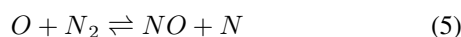

If combustion temperatures and residence time in the combustion chamber are minimized and appropriate amount of air is used during combustion then NOx emissions can be minimized as well

## II. MATERIALS AND METHODS

Waste in general refers to any material rejected as unfit for further use [12]. Waste Oil (WO) is defined as any oil that has been refined from crude oil or mixtures containing synthetic oil that has been used and is therefore contaminated [13]. The main chemical composition of WLO include carbon (C), hydrogen (H) and oxygen (O) elements. Others elements that appear in traces are nitrogen (N) and sulphur (S). It also contains ash and water that may have sipped into it through leaking seals during combustion process in engines. Therefore its major elements involved in a combustion reaction are C and H and O<sub>2</sub> is required as an oxidizer. The others that appear in traces are dropped and hence its chemical equation can be determined. Table I below represents WLO chemical compositions as posted by Gomez-Rico, Martin-Gullon, Fullana, Conesa and Font [14].

TABLE I  
PROPERTIES OF WASTE LUBRICATION OIL

Constituents	% weight	Element	Atomic wt (kg/kg mole)
Carbon	85.35	C	12
Hydrogen	13.25	H <sub>2</sub>	2
Oxygen	0.09	O <sub>2</sub>	32
Nitrogen	0.9	N <sub>2</sub>	28
Sulphur	0.46	S	32
H <sub>2</sub> O	-	-	18
CO <sub>2</sub>	-	-	44
SO <sub>2</sub>	-	-	64
Ash	0.05	-	-

Lower heating value (LHV) for this waste lubrication oil was determined as 48.17 MJ/kg. The values in Table I above were used to determine moles for each fuel constituent and hence WLO chemical formula expressed as C<sub>7.104</sub>H<sub>13.25</sub>O<sub>0.006</sub>. This expression of WLO chemical formula is normalized as shown.

$$\begin{pmatrix} 7.104 C \\ 13.25 H \\ 0.006 O \end{pmatrix} = 7.104 \begin{pmatrix} C \\ 1.865 H \\ 0.0008 O \end{pmatrix}$$

Normalized WLO chemical formula is therefore expressed as CH<sub>1.865</sub>O<sub>0.0008</sub>. A balanced Stoichiometric Reaction between WLO and air is therefore given by Equation 7 below:

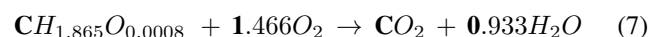

Properties of WLO as experimentally determined were as shown in Table II below.

TABLE II  
PROPERTIES OF WASTE LUBRICATION OIL

Test	Mean Value
LHV (pure diesel engine WLO)	43.39 MJ/kg
LHV (mixture of diesel and petrol engine WLO)	42.98 MJ/kg
Moisture content	0 %
Density	875.9 kg/m <sup>3</sup>
Relative density	0.8759
Kinematic viscosity at 25 <sup>0</sup> C	1371.5 Centistoke
Insoluble residue	0.056 %
Flash point	202 <sup>0</sup> C
Ash content	0.765 %

WLO fuel was burnt at three different flow rates of 5.05 kg/h, 5.65 kg/h and 6.25 kg/h and excess air (EA) of 12 %, 20% and 30% EA).

#### A. 5.05 kg/h Fuel Flow Rate

Fuel mass flow rate,  $\dot{m}_{fuel}$  in kg/h, is used to determine flow rate of each of carbon fuel and oxygen as 1.403 g/s.

Carbon mass flow rate,  $\dot{m}_{fuel(C)}$ , is given by Equation 9 below.

$$\dot{m}_{fuel(C)} = 0.8525 \times \dot{m}_{fuel} \quad (8)$$

$$= 0.8525 \times 1.403 = 1.196 \text{ g/s} \quad (9)$$

And Fuel carbon molar flow rate,  $\dot{n}_{fuel(C)}$ , is thus deduced as:

$$\dot{n}_{fuel(C)} = \frac{\dot{m}_{fuel(C)}}{\text{molar weight of carbon}} \quad (10)$$

$$= \frac{1.196 \text{ g/s}}{12 \text{ g/mole}} = 0.0997 \text{ moles/s} \simeq 0.1 \text{ moles/s} \quad (11)$$

Oxygen molar flow rate is therefore calculated as shown below.

$$\dot{n}_{fuel(O_2)} = \dot{n}_{fuel(C)} \times SC_{O_2} = 0.1 \times (1.466 + 0.0008) \quad (12)$$

$$= 0.14668 \text{ moles/s} \simeq 0.147 \text{ moles/s} \quad (13)$$

where:  $SC_{O_2}$  is the amount of oxygen required for stoichiometric combustion to take place.

Oxygen volume flow rate at room temperature and pressure (RTP),  $\dot{V}_{O_2@RTP}$  is given as:

$$\dot{V}_{O_2@RTP} = 24 \text{ L/s} \times \dot{n}_{fuel(O_2)} \quad (14)$$

$$= 24 \text{ L/mole} \times 0.147 \text{ moles/s} = 3.52 \text{ L/s} \quad (15)$$

24 L/mole is used in the above equation because it is the capacity of atmospheric air at standard conditions.

Atmospheric air volume flow rate at RTP,  $\dot{V}_{air@RTP}$ , is therefore deduced as:

$$\dot{V}_{air@RTP} = \frac{\dot{V}_{air@RP}}{0.21} = \frac{3.52}{0.21} \quad (16)$$

$$= 16.763 \text{ L/s} = 1.006 \text{ m}^3/\text{min} \quad (17)$$

#### B. 5.65 kg/h Fuel Flow Rate

$$5.65 \text{ kg/h} \equiv 1.569 \text{ g/s} \quad (18)$$

$$\dot{m}_{fuel(C)} = 0.8525 \times 1.569 = 1.338 \text{ g/s} \quad (19)$$

$$\dot{n}_{fuel(C)} = \frac{1.338 \text{ g/s}}{12 \text{ g/mole}} = 0.111 \text{ moles/s} \quad (20)$$

$$\dot{n}_{fuel(O_2)} = 0.111 \times 1.4668 = 0.164 \text{ moles/s} \quad (21)$$

$$\dot{V}_{O_2@RTP} = 24 \text{ L/mole} \times 0.164 \text{ moles/s} = 3.925 \text{ L/s} \quad (22)$$

$$\dot{V}_{air@RTP} = \frac{3.925}{0.21} = 18.691 \text{ L/s} = 1.121 \text{ m}^3/\text{min} \quad (23)$$

#### C. 6.25 kg/h Fuel Flow Rate

$$6.25 \text{ kg/h} \equiv 1.736 \text{ g/s} \quad (24)$$

$$\dot{m}_{fuel(C)} = 0.8525 \times 1.736 = 1.48 \text{ g/s} \quad (25)$$

$$\dot{n}_{fuel(C)} = \frac{1.48 \text{ g/s}}{12 \text{ g/mole}} = 0.123 \text{ moles/s} \quad (26)$$

$$\dot{n}_{fuel(O_2)} = 0.123 \times 1.4668 = 0.181 \text{ moles/s} \quad (27)$$

$$\dot{V}_{O_2@RTP} = 24 \text{ L/mole} \times 0.181 \text{ moles/s} = 4.342 \text{ L/s} \quad (28)$$

$$\dot{V}_{air@RTP} = \frac{4.342}{0.21} = 20.675 \text{ L/s} = 1.241 \text{ m}^3/\text{min} \quad (29)$$

### III. EXPERIMENTAL SETUP

Waste Lubrication Oil burner having reactants flow regulators was used in this study. This burner had a fuel pump with variable flow pressure upto a maximum of 15 bar, variable flow air supply blower, fuel atomizing nozzle of 60° spray angle and atomization rate of 5.68 L/h. Figures 1 and 2 below show schematic and pictorial views respectively of the setup used during the experiments.

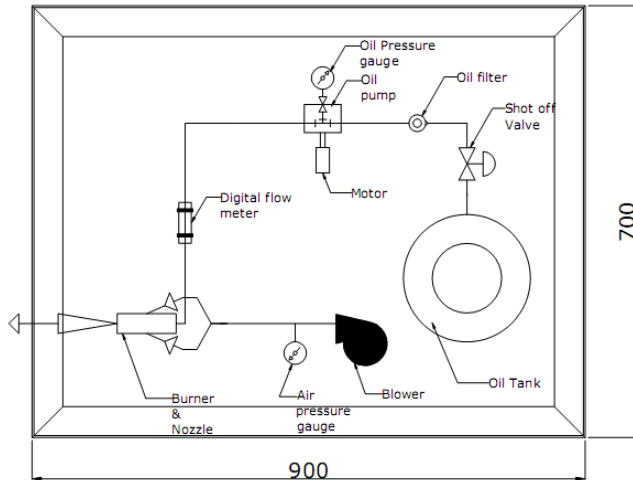

Fig. 1. Schematic Illustration of the burner setup

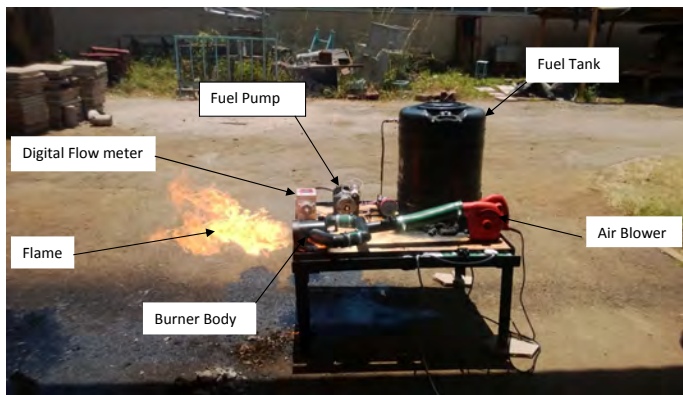

Fig. 2. Pictorial view of the burner setup

#### A. Working Procedure

The burner was setup for the tests to determine the effect of fuel flow rate and excess air on combustion emissions (CO, CO<sub>2</sub> and unburnt HC). Three different fuel flow rates (5.05 kg/h, 5.65 kg/h and 6.25 kg/h) were used each with individual excess air (EA) of 12%, 20% and 30% in combustion. Fuel flow rates were measured using an Oval Gear Digital flow meter with a provision to reset the readings and an in-built memory to show the immediate previous reading. Combustion emissions were monitored using a MEXA-544GF emissions analyzer which had a probe directed at the burner system exhaust to sample exhaust emissions and display them as %

volume for CO and CO<sub>2</sub> and parts per million (ppm) for the UHC.

### IV. RESULTS AND DISCUSSIONS

#### A. Burner Combustion Emissions

WLO burner emissions were monitored at minimum fuel flow rate that initiated ignition, maximum fuel flow rate and an intermediate flow rate with EA of 12%, 20% and 30% for each test. 30% EA was the maximum used since too much EA in a combustion process results in the unused excess oxygen carrying away with it some heat energy thereby reducing system's thermal efficiency. The following emissions were monitored and recorded:

1) *Carbon Monoxide*: Carbon monoxide emissions were recorded and added up for each EA value and fuel flow rate to get average CO emission from the combustion process. Graphs of CO emission concentration versus fuel flow rates at various EA values were then plotted as shown in Figure 3.

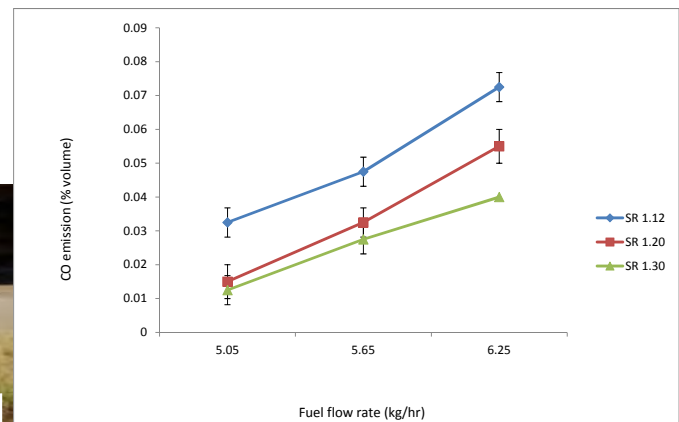

Fig. 3. WLO Burner CO emission at various SR values and fuel flow rates

CO emission increased with increasing fuel flow rate but decreased with an increase in amount of excess air with 30% excess air combustion having the least amount of CO. CO is an intermediate species formed before CO<sub>2</sub> in a hydrocarbon combustion. It is formed once fuel and intermediate hydrocarbon fragments are consumed as shown in Equations 1 and 2 above.

CO is a toxic gas and therefore large exposure to its emission can result into significant toxicity of the central nervous system, heart and eventually death [15]. The highest CO emission was recorded as 0.0725% volume at fuel flow rate of 6.25 kg/h and 12% EA which was also equivalent to 725 ppm of CO emission. This was attributed to the fact that there was an increase in fuel flow rate allowing large amount of fuel to pass into combustion chamber at any given time. Excess air being minimum and fuel quantity maximum, a fuel rich combustion resulted and hence there was oxygen deficit to fully oxidize CO species formed to CO<sub>2</sub>. Therefore, much

of this CO left combustion chamber to the exhaust as emission.

The CO emission concentration depicted a marked reduction between the maximum and minimum EA used during combustion with fuel flowing at a maximum rate of 6.25 kg/h. CO is a toxic gas and its reduction is therefore desirable and highly recommended. CO emission reduction achieved in burning WLO was 44.83%. This verified the fact that EA is required for a nearly complete combustion to occur. Lou, Huang and Yang [16] studied emission concentration in a combustion process and reported that in a combustion process, CO concentration decreased as flame temperature increased with EA of upto 25% used. Excess air can improve fuel oxidation, improve combustion efficiency as well as lower flue gas temperature. According to experiments done by Lou, Huang and Yang on municipal solid waste combustion, the exit flame temperature increased to a maximum of 650 °C with EA upto 30% after which it started decreasing.

Even with much excess air used in a combustion process a perfectly complete combustion can still not be achieved. A complete combustion can never be achieved with both stoichiometric air and excess air simply because of two main reasons:

- It is not possible to create enough turbulent to facilitate sufficient fuel and oxidizer mixing.
- The mixing time is usually very short which may not warrant complete and sufficient mixing of fuel and oxidizer.

2) *Carbon Dioxide*: CO<sub>2</sub> is one of the by-products of a combustion process along side water vapour. The higher the volume of CO<sub>2</sub> generated the higher the efficiency of a combustion process. It can therefore be used as an indicator of a complete combustion. Figure 4 below shows variations of CO<sub>2</sub> emissions with fuel flow rates at various EA values.

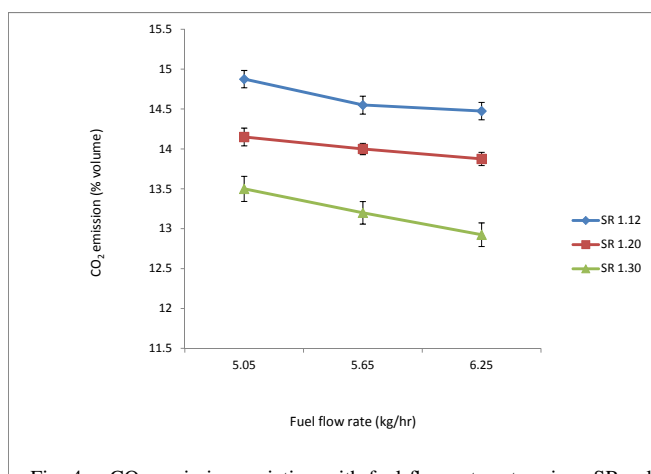

Fig. 4. CO<sub>2</sub> emission variation with fuel flow rates at various SR values

An excess air of 12% and fuel flow rate of 5.05 kg/hr resulted in formation of maximum CO<sub>2</sub> as product of combustion. This was due to the fact that more excess air relative to

the amount of fuel supplied resulted to a lean combustion. More intermediate species (CO) formed was oxidized to CO<sub>2</sub> by oxygen atoms formed during chain initiation process. Excess air facilitated more fuel oxidation to a near complete combustion and more CO<sub>2</sub> generation in the process. CO<sub>2</sub> generation decreased with increasing excess air. This was as a result of the extra air supplied cooling the combustion system by absorbing heat and transporting it out in the flue gases thereby reducing combustion temperatures. Cooling contributed in slowing down the reaction thereby reducing the amount of combustion byproducts generated. Cooling also slowed down CO oxidation to CO<sub>2</sub> as this process is accelerated at temperatures above 1100 K. Excess air also diluted flue gases further contributing to reduction in CO<sub>2</sub> concentration. A maximum difference of 11.99% CO<sub>2</sub> emission was achieved between the minimum and maximum SR values at fuel flow rate of 6.25 kg/hr.

3) *Unburnt Hydrocarbon (UHC)*: Complete and efficient combustion is quite difficult to achieve. It is therefore expected that some fuel particles will leave combustion chamber to the exhaust unburnt to form UHC. Figure 5 shows UHC concentration results for 12% EA, 20% EA and 30% EA at various fuel flow rates.

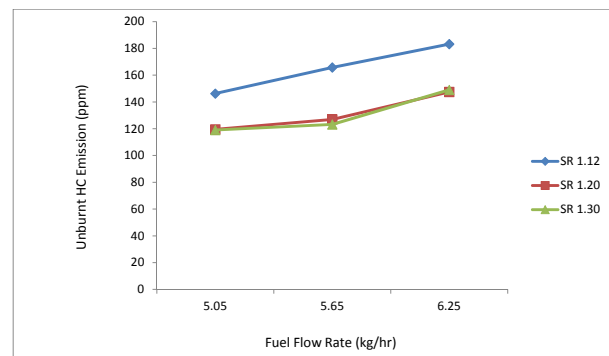

Fig. 5. UHC emission variation with fuel flow rates at various SR values

18.63%, 25.64% and 18.69% reduction in UHC concentration were observed at 5.05 kg/h, 5.65 kg/h and 6.25 kg/h fuel flow rates respectively. Maximum UHC recorded was 183.25 ppm at 12% EA and fuel flow rate of 6.25 kg/h. It was attributed to the fact that more fuel was pumped to the burner atomizing nozzle at minimum EA of 12% and therefore most of it passed through the combustion chamber unburnt due to limited oxygen supplied to fully oxidize fuel. Fuel nature dictates its reaction speed relative to flame speed and this influences formation of UHC emission. Lower flame speeds compared to fuel reaction speed leads to more UHC generation. This means less mass fraction of the fuel is burnt and much of it passes to the exhaust unburnt [17]. This could be one of the reason why much UHC resulted during WLO combustion experiments.

Emissions comparison graphs for each EA value are presented

in Figures 6, 7 and 8 below. From all the graphs, it can be observed that CO<sub>2</sub> emission reduced for all EA values while both CO and UHC increased with increasing EA.

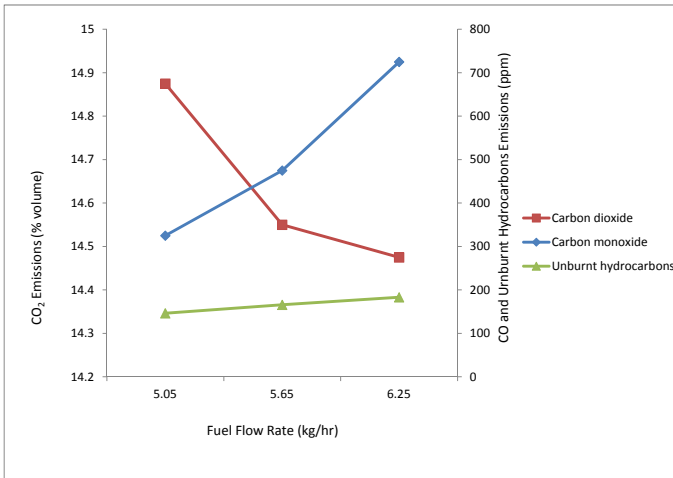

Fig. 6. Combined emission versus fuel flow rate at SR1.12

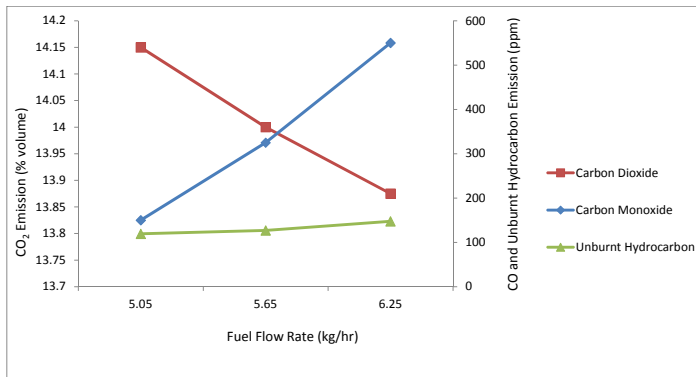

Fig. 7. Combined emission versus fuel flow rate at SR1.20

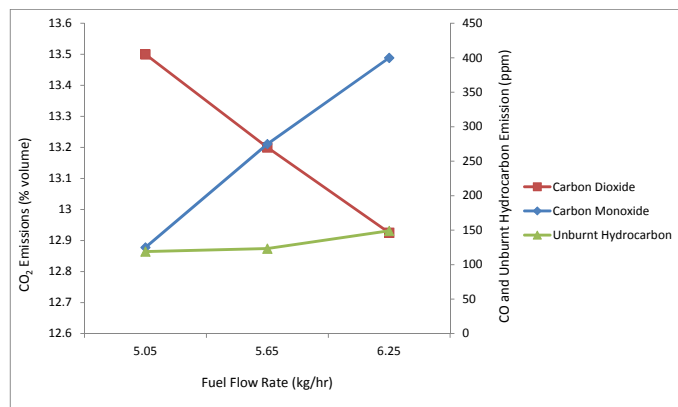

Fig. 8. Combined emission versus fuel flow rate at SR1.30

Emissions (CO<sub>2</sub>, CO and UHC) formation were mainly affected by excess air and combustion process efficiency (level of fuel atomization). An intermediate species, CO, was formed from reaction of fuel carbon with oxygen radical generated during chain initiation process. This CO then reacted further with more oxygen radicals to form CO<sub>2</sub>. More excess air implied more radical formation for more CO<sub>2</sub> generation. Conversion of more CO to CO<sub>2</sub> reduced CO amount in the

exhaust gases but increased CO<sub>2</sub> amount generated. This is the reason why CO<sub>2</sub> and CO graphs have an indirect relation. Both CO and UHC resulted due to incomplete combustion. An increase in CO emission in a combustion process was accompanied by an increase in UHC emission. UHC was also influenced by flame speed and fuel reaction speed. Higher fuel reaction speed than flame speed meant that more fuel passed through the combustion chamber unburnt to constitute UHC at the exhaust. Higher fuel flow rates at constant excess air value implied a rich fuel combustion and hence more CO and UHC generated. It is therefore concluded that CO<sub>2</sub>, CO and UHC emissions generation are dependent on one another.

## V. CONCLUSION

Combustion tests were done for WLO and emissions monitored at various fuel flow rates and EA supply. From results achieved, the following conclusions are made:

Combustion emissions can be regulated by varying both fuel flow and combustion air supply. The highest CO emission was recorded as 0.0725 % volume at a fuel flow rate of 6.25 kg/h and 12% EA. Maximum difference in CO<sub>2</sub> emission was achieved at a fuel flow rate of 6.25 kg/h. This was the difference between CO<sub>2</sub> emissions at 30% EA and 12% EA. The percent difference was got as 11.99%. Percent reduction in UHC concentration were recorded as 18.63%, 25.64% and 18.69% for 5.05 kg/h, 5.65 kg/h and 6.25 kg/h fuel flow rates respectively. Maximum UHC recorded was 183.25 ppm at 12% EA and fuel flow rate of 6.25 kg/h.

From the comparison graphs, CO<sub>2</sub> emission reduced for all EA values while UHC emission increased with increasing EA. CO emission also varied directly with fuel flow rate for all EA values.

## ACKNOWLEDGEMENTS

This research was financed by the Jomo Kenyatta University of Agriculture and Technology (JKUAT). The authors gratefully recognize the support and contribution from JKUAT Engineering workshops and laboratories staff during burner design, fabrication and testing.

## REFERENCES

- [1] M. Z. Jacobson, M. A. Delucchi, "Providing All Global Energy with Wind, Water, and Solar Power, Part I: Technologies, Energy Resources, Quantities and Areas of Infrastructure, and Materials," *Journal of Energy Policy*, vol. 39, pp. 1154 – 1169, 2011.
- [2] Martin M. Bunyasi, "Vulnerability of Hydro-Electric Energy Resources in Kenya Due to Climate Change Effects: The Case of the Seven Forks Project," *Journal of Agricultural and Environmental Sciences*, vol. 1, pp. 36 – 49, December, 2012.
- [3] World Energy Council, London, www.worldenergy.org, "World Energy Issues Monitor," 2013.
- [4] S. Patil, M. Akarte, "Effect of Injection Pressure on CI Engine Performance Fuelled with Biodiesel and its blends," *International Journal of Scientific and Engineering Research*, vol. 3, pp. 1 – 4, March, 2012.
- [5] A. Edward, E. Pechan, "Emission factor documentation for AP-42 section 1.11 waste oil combustion," *U.S Environmental Protection Agency*, April, 1993.

- [6] Washington State Department of Ecology, "Used Oil Facts," *Publication 02 - 04 - 006*, April, 2005.
- [7] S. Jhanani, J. Kurian, "Used Oil Generation and Management in the Automotive Industries," *International Journal of Environmental Sciences*, vol. 2, No. 2, 2011.
- [8] A. Benjamin, M. Patrick, "Energy sector liberalization in Kenya: Critical policy issues in petroleum retail market," *Energy Policy*, vol. 27, pp. 45 – 56, 1999.
- [9] A. F. Sherwani, A. Sharma, A. K. Yadav, "Comparative analysis of performance and emission parameters of a CI engine fueled with different blends of biodiesel derived from Mahua oil and waste cooking oil," *International Journal of Innovative Research in Science, Engineering and Technology*, vol. 2, Issue 9, pp. 4944 – 4952, September, 2013.
- [10] K. Arumugam, S. Veeraraja, P. Esakkimuthu, "Combustion of Waste/Used Oil by Using Specialized Burner," *International Journal of Applied Engineering Research*, vol. 8, pp. 1839 – 1846, 2013.
- [11] L. Jingding, "Formation and Restraint of Toxic Emissions in hydrogen-Gasoline Mixture Fueled Engines," *International journal of Hydrogen Energy*, vol. 23, pp. 971 – 975, 1998.
- [12] C. Kajdas, "Major Pathways for Used Oil Disposal and Recycling. Part 1," *Tribotest Journal*, vol. 7, pp. 61 – 74, 2000.
- [13] P. Zenon, U. Wieslaw, K. Tadeusz, S. Michal, "Energy conservation through recycling of used oil," *Ecological Engineering*, vol. 36, pp. 1761 – 1764, 2010.
- [14] M. F. Gomez-Rico, I. Martin-Gullon, A. Fullana, J. A. Conesa, R. Font, "Pyrolysis and combustion kinetics and emissions of waste lube oils," *Journal of Analytical and Applied Pyrolysis*, pp. 527 – 546, 2003.
- [15] J. A. Raub, "Health Effects of Exposure to Ambient Carbon monoxide," *Global Change Science*, vol. 1, pp. 331 – 351, 1998.
- [16] J. Lou, C. Huang, T. Yang, "Effect of Excess Air on Combustion Efficiency and Emissions from Incineration of Municipal Solid Wastes," *Journal of Chinese Institute of Environmental Engineering*, vol. 9, pp. 219 – 227, 1999.
- [17] C. A. Srinivasan, C. G. Saravanan, "Emission Reduction in SI Engine Using Ethanol - Gasoline Blends on Thermal Barrier Coated Pistons," *International Journal of Energy and Environment*, vol. 1, pp. 715 – 726, 2010.



# Pitting Corrosion Behavior of Duplex Stainless Steel (2205) in Thiosulfate-chloride Environment and in Simulated Hydrothermal Reactor /autoclave

John Gerald Odhiambo<sup>1a</sup>, Li Zhang<sup>2b</sup>, Shen Yuanyuan<sup>2</sup>, E. Musango Munyao<sup>1</sup>, Lihua Dong<sup>2</sup>

**Abstract**—The pitting corrosion behavior of DSS (2205) in 0.001, 0.01, 0.1 and 1M thiosulfate ion ( $S_2O_3^{2-}$ ) and 0.01%, 0.1%, 1% and 10% concentrations of chloride ion ( $Cl^-$ ) was studied using the linear potentiodynamic polarization method. The behavior of duplex stainless steel was also investigated for pitting in a hydrothermal vent reactor/autoclave. The hydrothermal reactor/autoclave was used to simulate deep sea environment with varying pressure in seawater. It was found that both the pitting potential (Epit) and the repassivation potential (Erp) decreased with increase in ( $Cl^-$ ) and ( $S_2O_3^{2-}$ ) concentrations. Pitting corrosion was also noted on the SEM images at high pressures in the reactor/autoclave.

**Keywords**—Duplex Stainless Steel-2205 (DSS), hydrothermal autoclave pitting corrosion, sodium thiosulfate.

## I. INTRODUCTION

Stainless steel is extensively used as a construction material in various aggressive environments such as oil and gas industries, pollution control equipment (FGD scrubber), wastewater treatment plants, building and bridges constructions and chemical plants. Stainless steel is resistant to corrosion due to the formation of a self-healing passive film; however, localized corrosion can occur in the presence of aggressive anionic species [1] [2]. Although chloride ions are small in size, highly diffusive and are strong acidic ionic nature, they do not cause corrosion but the general and pitting corrosion generates positive metal ions, thus aggravating the situation in the presence of these ionic charges. [3]. In deep sea exploration, it has been found that thiosulfate ions ( $S_2O_3^{2-}$ ) are in abundance and have also been reported as to have a deleterious effect to the stability of the passive film, especially in oxygen deficient areas [4] [5]. Apart from oxygen availability, the stability of the passive chromium film

formed on stainless steel and its susceptibility to breakdown also depends on pH, temperature, applied potential and solution composition and concentration [2]. Studies of S31726 S31254 S31803A S32750 and S32654 ( grades of duplex stainless steel)in chloride and in some cases thiosulfate solutions have shown that ions concentrations have effects on pitting behavior at varying temperatures and concentrations of solutions [6] [7].

This work was to study the effects of chloride ions and thiosulfate ions on the electrochemical corrosion behavior of duplex stainless in the presence of ( $S_2O_3^{2-}$ ) and 0.01%, 0.1%, 1% and 10% concentrations of chloride ion ( $Cl^-$ ) using polarization curves and also in a hydrothermal vent reactor/ autoclave. The morphology of duplex stainless steel from the hydrothermal autoclave was characterized by scanning electron microscopy (SEM).

## II. EXPERIMENTAL DETAILS

Test specimens were produced from duplex stainless steel 2205 UNS S31803 with the chemical composition (wt %): 0.03C%, 2.0Mn, 1.0Si, 0.03 P, 0.02 S, 23 Cr, 3.5 Mo, 6.5 Ni, 0.2 N, and balance Fe. Test coupons (working electrodes) of sizes 10mm×10mm×3mm were cut. The coupons were polished with a series of emery papers down to 1000 grit, rinsed in double distilled water and ethanol immediately before testing. For electrochemical monitoring, an electrical connecting wire was soldered to the back face of coupons then encapsulated in a temperature resistant epoxy resin. For hydrothermal autoclave testing, the coupons were put in a half inch pipe of length 30mm and both sides of the pipe were wrapped with Teflon tape.

Linear potentiodynamic polarization study was conducted using Autolab work station (AUT83924) model potentiostat/galvanostat controlled using a computer equipped with GPES Nova 1.8 software. A conventional three-electrode glass corrosion cell with a capacity of 500 ml was used to measure linear potentiodynamic polarization. A saturated calomel electrode (SCE) was used as the reference electrode; a platinum slice with an area of 4 cm<sup>2</sup> was used as the

John Gerald Odhiambo, Department of Marine Engineering and Maritime Operations, JKUAT (phone: +2540708816363; fax: +2546752711; e-mail: geraldjo@jkuat.ac.ke)

Li Zhang, College of Ocean Science and Engineering, Shanghai Maritime University, 1550 Haigang Av. Lingang New City, Shanghai 201306, China

counter electrode. The solutions were prepared using analytical reagent grade chemicals and double distilled water. For hydrothermal autoclave tests, seawater was used in the autoclave and the pressures varied from 1Mpa, 30 and 70Mpa at room temperature of 25°C. Mass changes were recorded and SEM was conducted on the morphological structure. Samples from copper-nickel alloy 8825 and high strength steel 980 were used in the hydrothermal test for comparison reasons.

### III. RESULTS AND DISCUSSION

#### A. Polarization curves

##### i. Effects of sodium chloride ions

The potentiodynamic polarization curves for DSS in the presence of various concentrations of Cl<sup>-</sup> ions in NaCl solution at room temperature (15-20°C and pH 7) are shown in figure 1 (a). It is clear from the curves that DSS suffers from pitting corrosion at high Cl<sup>-</sup> ion concentrations. At lower levels of Cl<sup>-</sup> ions i.e. 0.01%, 0.1% and 1% NaCl the pitting is low due to passivation layer. With increase in Cl<sup>-</sup> concentration to higher levels, the passivation zone is narrowed up to a level making DSS prone to pitting corrosion. At a particular Cl<sup>-</sup> ions concentration, an Epit develops which is sufficient to displace oxygen from the protective oxide layer. Some authors have argued that with the presence of microorganisms such as bacteria, the initiation of pitting of stainless steel is hastened [8] [9]. The specimens tested showed a similar pattern of anodic peaks at approximately the same corrosion current densities though with varied electrode potentials.

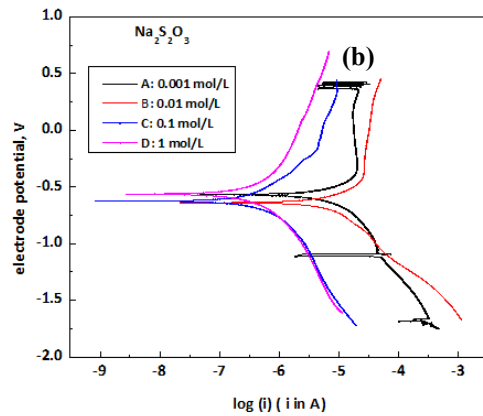
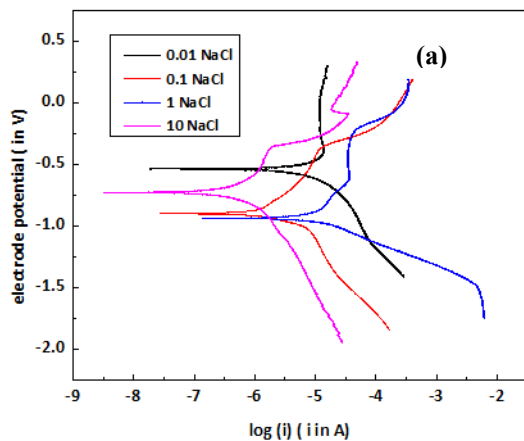

Figure 1 Potentiodynamic polarization curves of specimens of DSS 2205 in of various concentrations; (a) NaCl solutions (b) Na<sub>2</sub>S<sub>2</sub>O<sub>3</sub> solutions

The anodic peaks were apparent in 0.01, 0.1 and 1%. At 10%, which is far much more than the normal chloride ions level in the seawater, [5] [10], it was expected that it would have the maximum pitting effects, but it showed signs of oversaturation.

##### ii. Effects of sodium thiosulfate ions

The potentiodynamic polarization curves for DSS 2205 in the presence of various concentrations of (S<sub>2</sub>O<sub>3</sub><sup>2-</sup>) ions in Na<sub>2</sub>S<sub>2</sub>O<sub>3</sub> solution at room temperature (15-20°C and pH 7) are shown in Figure 1(b). It is clear from the curves that the DSS suffers from pitting corrosion at high S<sub>2</sub>O<sub>3</sub> ion concentrations. At a particular concentration an Epit develops which is sufficient to displace oxygen from the protective oxide layer. It was found also that (S<sub>2</sub>O<sub>3</sub><sup>2-</sup>) concentration has a pronounce defect on Epit values. The Epit decreased with increase in Cl<sup>-</sup> concentration. It was also found that corrosion potential (E<sub>corr</sub>) values changed slightly towards active direction with increase in chloride ion concentration. Hence DSS was susceptible to pitting attacks in higher concentrations.

#### B. Hydrothermal tests

The hydrothermal tests were done on three samples for each material tested. The hydrothermal treatment of samples at room temperature i.e. 20-25 °C, from 24 to 72 hours with varying pressures showed no physical changes on the materials at 1MPa. The coupon treated at 70MPa showed some pits, larger in size compared to the pits shown for coupons treated at 30MPa. There was slight mass changes from the initial and posttest specimen. The corrosion was first assessed from the weight loss of coupons after immersion in the hydrothermal autoclave for the predetermined period of time (24-168 hours). The total area of each coupon was determined for every experiment, because two coupons may be identical in mass, but different in shape and surface area. The increase in the surface area means more area on which the bacteria can bind. Therefore, the surface area has a

significant effect upon the corrosion rate. The surface analysis of the coupons was performed with a scanning electron microscope.

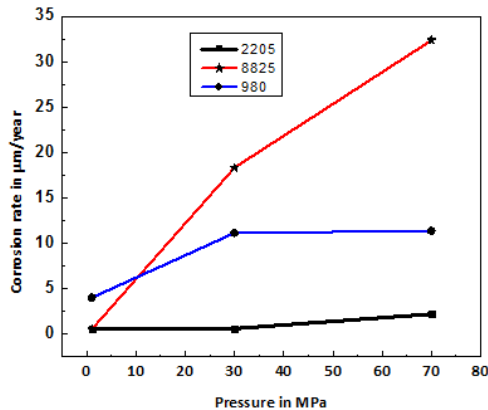

Figure 3 Corrosion rates of 2205, 8825 and 980 with varying pressure

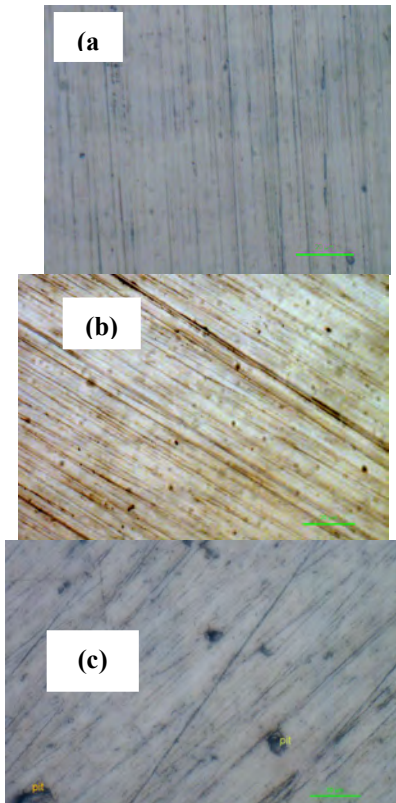

Figure 4 Scanning electron microscopy images of DSS after 168 hours; (a) at 1 atmosphere, (b) 30MPa and (c) 70MPa

Figure 4 shows corrosion rates against pressure variation in the hydrothermal autoclave. It is clear that copper-nickel alloys (8825) had the most mass loss, followed by high strength steel (980). DSS (2205) had the least mass loss and hence had the lowest corrosion rate. DSS has been used in high pressure and high temperature places because it can withstand both high pressure and temperatures well without compromising on its physical and mechanical properties, and at the same time having excellent corrosion properties.

#### IV. CONCLUSION

Epit values of duplex stainless steel were found to shift in the active direction with increase in both  $(Cl^-)$  and  $(S_2O_3^{2-})$  concentrations. It was found that the DSS is more susceptible to pitting corrosion at higher  $(Cl^-)$  and  $(S_2O_3^{2-})$  concentration. For hydrothermal tests, DSS was found to be more resistant to pitting compared to the other specimens used i.e. copper nickel alloy (8825) and with high strength steel (980) being the most susceptible to pitting corrosion in the autoclave with varying pressure. It was also noted that pitting increased with increase in pressure.

#### V. ACKNOWLEDGEMENT

This work was financially supported by the National Natural Science Foundation (51101098, 51003056), National Basic Research Program of China (2014CB643306), Innovation Program of Shanghai Municipal Education Commission (12231204102) and Shanghai Foundation for Development of Science and Technology (12231204102).

#### REFERENCES

- [1] J. Charles, "Duplex stainless steels, A review after DSS'07 held in GRADO," Arcelor Mittal Stainless, La Plaine Saint-Denis, France, 2007
- [2] A.I. Almarshad And D. Jamal: Electrochemical investigations of pitting corrosion behaviour of type UNS S31603 stainless steel in thiosulfate-chloride environment
- [3] W.S. Tait, An Introduction to Electrochemical Corrosion Testing for Practicing Engineers and Scientists,, University of Win cousin-Madison, Racine, 1994.
- [4] F. Pirajno, "Hydrothermal Processes and Mineral Systems," in Hydrothermal Processes and Mineral Systems, Australia, Springer, 2010, pp. 10-21
- [5] P. R. Roberge, "Corrosion Engineering: Principles and Practice," in Corrosion Engineering: Principles and Practice, McGraw Hill, 2008, p. 278.
- [6] R. Pettersson, Arne B. Sophia G. Carinci "Corrosion of austenitic and duplex stainless steels in flue gas cleaning systems for waste combustion processes," A corrosion management and application engineering magazine from outokumpu, 2 2013
- [7] S. J. Clarke and N. J. Stead, Pulp and Paper Research Institute of Canada, 3800 Westbrook Mall, Vancouver, British Columbia, Canada V6S 2L9 corrosion management and application engineering magazine from outokumpu, 2 2013
- [8] S. J. Clarke and N. J. Stead, Pulp and Paper Research Institute of Canada, 3800 Westbrook Mall, Vancouver, British Columbia, Canada V6S 2L9
- [9] Z. Lewandowski, M. Geisera and R. Avci "Microbially initiated pitting on 316L stainless steel," international bio deterioration & degradation, pp. 235-243, 2002.
- [10] S.J. Yuan, and S.O Pehkonen "Microbiologically influenced corrosion of 304 stainless steel by aerobic Pseudomonas

NCIMB 2021 bacteria: AFM and XPS study," *Colloids and Surfaces B: Bio interfaces*, pp. 87-99, 2007.

- [11] E. Lewis, "The practical salinity scale 1978 and its antecedents," *Journal of Oceanographic Engineering* 5(1), pp. 3-8, 1980.

# A Review of Heliostat Technologies used in Concentrated Solar Power Plants

Timothy Kiptui Kangogo and Karanja S. Kabini

**Abstract**—There are several technologies used in solar thermal energy generation. One such technology is the use of heliostats. In most cases, plane mirrors are preferred as compared to parabolic mirrors in concentrated solar power (CSP) plants mainly because of the former's ease of manufacture. Plane mirrors are used in such CSP plants as the Abengoa Solar's PS20 installed near Seville, Spain and Ivanpah's installed in California's Mojave Desert. The challenge with using plane mirrors in CSP plants is that they call for employment of more sophisticated heliostats as opposed to relatively simple sun trackers employed in parabolic mirrors. The main focus of this paper is, therefore, on heliostats used to focus sun rays to centralized solar power towers in CSP plants. To this effect, the available heliostat technologies are reviewed with a view to identifying their short comings and propose possible improvements to the same. All these will be done in the context of concentrated solar power plants. In the review, it was found that the main challenges facing heliostat technology are the high cost, high levels accuracy required, wind loads on the plane mirrors and dust settling on the plane mirrors.

**Keywords**—Heliostats, plane mirrors, parabolic mirrors, concentrated solar power (CSP), sun trackers.

## I. INTRODUCTION

CURRENTLY, solar energy is mainly harnessed (on a small scale) by employing photovoltaic or thermal energy solutions. Photovoltaic solution is where silicon based photovoltaic panels are used to convert solar energy to electricity. Thermal solution is where sunlight is used to heat a fluid for example the solar heating of water for domestic use. Solar water heating panels use un-concentrated sunlight to heat water. Other technologies exist which concentrate sunlight and are referred to as Concentrated Solar Power (CSP) systems.

Concentrated solar power (CSP) is a system in which a large area of sunlight is concentrated onto a small area using mirrors or lenses. The concentrated sunlight becomes hot and the heat can be converted into mechanical energy (by employing a working fluid as in the case of a steam plant).

The four primary types of CSP technologies are:-

1. Parabolic Troughs,
2. Fresnel Systems,

3. Central Receivers (Heliostat arrays) , and
4. Parabolic Dishes.

### A. Parabolic Dishes

The parabolic dish resembles a parabolic mirror and concentrates sunlight to its focal point. The parabolic dishes are a common sight in Kenyan Agricultural Shows and Trade Fairs. They are usually made by lining the concave surface of a parabola shaped sheet metal with reflective aluminium foil. The sheet metal is stamped (cold worked) using appropriate dies. The parabolic dishes in Kenya are used for solar cooking. Fig. 2 (b) shows a cross-section of a parabolic dish, incident sun rays, reflected sun rays and a sufuria at the focal point of the parabola.

### B. Parabolic Troughs

The cross-section of a parabolic trough is similar to that of a parabolic dish as shown in Fig. 2 (b). The reflected sun rays are focused to a line and not to a point as in the case of a parabolic dish. A tube containing the fluid to be heated is positioned at the focal axis as shown in the diagram.

### C. Fresnel Systems

The Fresnel system is a system where many thin strips of flat mirrors are arranged as though they form part of a parabolic mirror. Each of the strips of flat mirrors is tilted to a unique angle so that it reflects sunlight to a specific point. The advantage of fresnel system is that strips of flat mirrors are cheaper to manufacture as compared to a parabolic mirror. Fig. 2 (c) shows the strips of flat mirrors arranged to form a fresnel system.

### D. Central Receivers

Central receivers are strategically positioned tanks that contain the working fluid. The tanks (receivers) are either placed on a tower and a number of flat mirrors on a lower level (ground) reflect sunlight upwards towards them or the receivers are located at the valley bottom and a number of flat mirrors on the surrounding hillside reflect sunlight

Timothy Kiptui Kangogo, Department of Mechanical Engineering, JKUAT (phone: +254 712513603; e-mail: kiptuikangogo@gmail.com).

Karanja S. Kabini, Department of Mechatronics Engineering, JKUAT (phone: 0720980179; e-mail: skkabini@gmail.com).

downwards towards them. Fig. 1 shows a receiver on a tower and on flat mirror reflecting sunlight downwards towards it (the receiver).

The Heliostat-Central Receiver configuration offers great potential in terms of power cycle efficiency (it is the technology that can reach the highest temperature). Future anticipated developments of specialized gas turbines suitable for renewable will need to operate at such very high temperatures (over 600o C). The Central Receiver technology also offers the greatest potential for storage at high temperatures (essential for 24 hour operation) and has been receiving increasing research attention both in Europe and the US [1]. A most important advantage of the Heliostat – Central Receiver system over the Parabolic Trough and Fresnel systems, critical for CSP application, concerns the flexibility it offers for the placement of the heliostat field on a hilly terrain. The utilization of flat terrain puts heavy restrictions for the implementation of a CSP plant in a rugged terrain (Troughs and Fresnel could in principle be deployed on gentle slopes with a constant gradient and the correct orientation, a rather infrequent combination of conditions) [2].

The biggest drawback of CSP systems as used in power generation is that the system will not generate power at night and will generate little or no power during heavy cloud cover. In an attempt to supply power continuously for 24hours a day, a lot of research has gone into the use of molten salt to store thermal energy for extended periods of time (24hrs)

The flat mirrors in the central receiver system have to track the sun as it moves across the sky and reflect the sunlight to a fixed point on the receiver. In the central receiver system, the device that constantly orients the flat mirror so that it reflects sunlight from the constantly moving sun to the fixed receiver is called a Heliostat. This paper aims to review heliostats by highlighting their construction and mode of operation. It also aims to highlight challenges faced in heliostat operation and tries to suggest solutions to the challenges. The review is important because it creates awareness of heliostats. Heliostats are in many instances confused with solar trackers. Such unfamiliarity with key renewable energy technologies as heliostats is unacceptable, especially in this era where engineers strive to harness ‘green energy’.

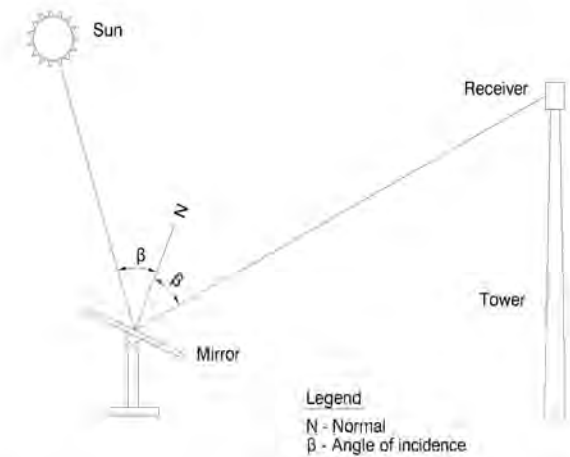

Fig. 1 Shows the incident ray, the reflected ray and the normal

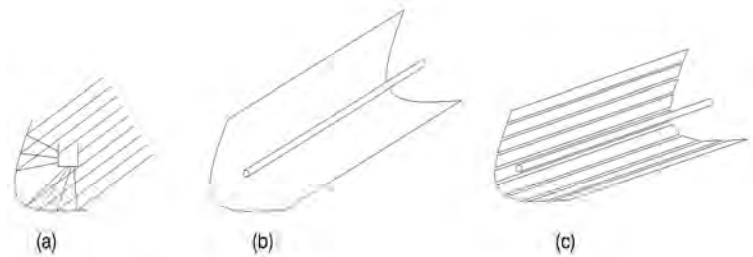

Fig. 2 Shows (a) Cross-section of parabolic dish, (b) Parabolic trough (c) Fresnel system

## II. HELIOSTATS VERSES SUN TRACKERS

Heliostats and sun trackers are closely related in terms of their function and their mode of operation. They both unwittingly track or follow the sun and both need information on the sun's position during their operation. Both obtain information on the sun's position by use of appropriate sensors or the information is fed to them from a computer memory. A number of apparent positions of the sun in the sky for a number of latitudes (but the same longitude) at different times are fed into a computer memory. Given the latitudes, longitudes and altitudes of the heliostat and receiver, and given the time, a programmed computer can determine an appropriate orientation for a heliostat. The same input information, (except for the altitude, latitude and longitude of the receiver), is needed by a programmed computer in order to determine appropriate orientation of the sun tracker.

The main difference between a heliostat and a sun tracker is that sun tracker continuously moves to keep a flat device like a photovoltaic (PV) panel oriented in a plane perpendicular to the direction of solar radiation. Solar trackers are mostly used in the PV solar energy industry because, due to the continuous change in the relative

positions of the sun and the earth, the incident radiation on a fixed photovoltaic panel is continuously changing, reaching a maximum point when the direction of solar radiation is perpendicular to the panel surface. In that context, for maximal energy efficiency of a PV panel, it is necessary to have it equipped with a solar tracking system. Most solar tracker manufactures claim that a fixed PV panel has a solar energy conversion efficiency of about 13% but this increases to 30 – 35% when solar trackers are employed (when the PV panel is mounted on a solar tracker). The ultimate goal of solar trackers is therefore to orient devices (primarily PV panels) at a plane normal to solar radiation as shown in Fig. 3.

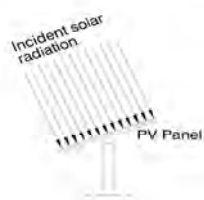

Fig. 3 Shows how a solar tracker orients the PV panel normal to the incident solar radiation

On the other hand, the ultimate goal of a heliostat is to reflect sunlight to a specific point. As shown in Fig. 1, the heliostat orients the mirror to be perpendicular to the plane formed by the incident and reflected rays. The incident and reflected rays meet at the normal to the plane mirror as shown in Fig. 1. Notice also that the angle of incidence ( $\beta$ ) is equal to the angle of reflection.

### III. SENSOR CONTROLLED SUN TRACKERS AND HELIOSTATS

In chapter II, it was mentioned that the movement of solar trackers and heliostats can be sensor controlled or controlled by a computer using an algorithm, date, time, altitude, latitude, longitude and solar diurnal data stored in a computer memory as inputs. Sensor controlled solar trackers and heliostats primarily use a form of light sensors. For solar trackers, the light sensors are arranged depending on whether the trackers are single axis trackers or dual axis trackers. Single axis trackers have one-degree of freedom which is usually an East-West rotation about a North-South axis. Single axis solar trackers can track the sun as it moves from East to West across the sky but cannot track the sun as it moves in a North-South direction with the seasons. The sun is at its south-most position (over-head the tropic of Capricorn) on 21<sup>st</sup> December and is at its north-most position (overhead the tropic of Cancer) on 21<sup>st</sup> June. Dual axis trackers have two-degrees-of-freedom and can track the sun in both East-West and North-South directions.

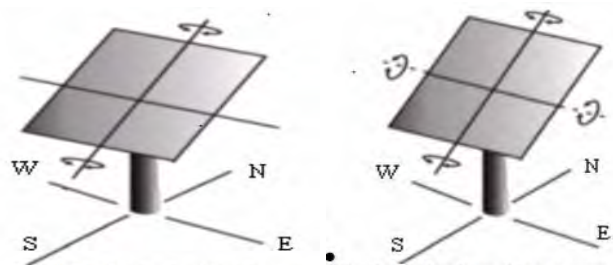

Fig. 4. Single axis tracking system Fig. 5. Dual axis tracking system

For sensor controlled single axis solar trackers, the common sensor arrangement is as shown in Fig. 6 (a). Two light sensors S1 and S2 are separated by a rectangular plate (called bridge) so that S1 is to the east of the bridge and S2 is to the west of the bridge as shown. If for instance the sun is at a low elevation angle in the east as shown, sensor S1 is exposed to sunlight while S2 is shadowed as shown by the plan view Fig. 6 (b). The difference in light intensity as measured by S1 and S2 causes a servo motor to turn the solar tracker in a clockwise direction about the North-South axis as shown in Fig. 6 (a).

For sensor controlled dual axis solar trackers, sensor pairs S1, S2 and S3, S4 are responsible for East-West rotation about the North-South axis. Sensor pairs S1, S3 and S2, S4 are responsible for North-South tracking of the sun by rotation about the East-West axis. Heliostats that use light sensors to obtain the position of the sun in the sky employ this type of dual axis solar tracker.

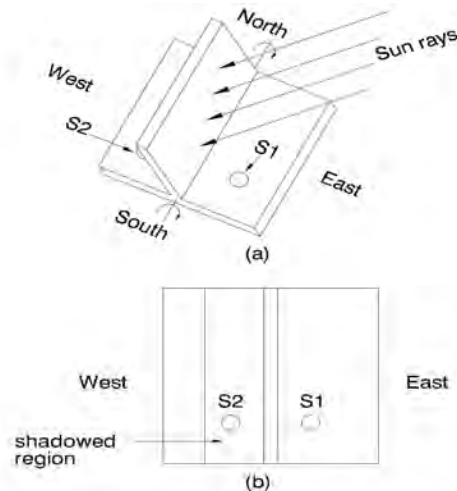

Fig. 6 Shows the common arrangement of light sensors (S1 and S2) in a single axis solar tracker

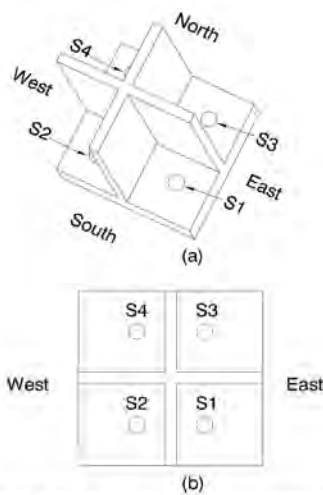

Fig. 7 Shows the common arrangement of light sensors (S1, S2, S3 and S4) in a dual axis solar tracker

In summary therefore, a heliostat is a device that turns a mirror so that the mirror reflects sunlight to a specific target (the target may be stationary or in motion). The heliostat reflects light to the target (receiver) by coordinating mirror movements with solar diurnal movements, using two control axes. The devices are used exclusively in large-scale solar power plants. Various mirror sizes and drive systems are being developed by a number of manufacturers. The settings of the two axes vary, but the most commonly used configurations are the alt-azimuth mount which consists of a vertical pivot and a tilt axis rotating around the pivot, and the equatorial mount which consists of a polar axis and an orthogonal declination axis. Various mirror sizes are currently available, the smallest of which is 1 square metre, while the largest exceeds 100 square metres. The number of heliostats used in a typical system is enormous, and the cost impact is significant. Hence, the development of a low-cost, high-accuracy heliostat is a necessity [3].

Older types of heliostats were partly or wholly operated by hand or by clockwork, or were controlled by light-sensors. Most modern heliostats are controlled by computers. The computer is given the latitude and longitude of the heliostat's position on the earth (using GPS) and the time and date. From these, using astronomical theory, it calculates the direction of the sun as seen from the mirror, e.g. its compass bearing and angle of elevation. Then, given the direction of the target (receiver), the computer calculates the direction of the required angle-bisector, and sends control signals to motors, often servo motors, so they turn the mirror to the correct alignment. This sequence of operations is repeated frequently to keep the mirror properly oriented.

#### IV. CALIBRATION

When the drive system of a heliostat is commanded by the control unit to turn the mirror to a given position, the final position reached by the mirror is not necessarily that commanded by the control unit. This is because of inaccuracies of the drive system that result from backlash in gear trains, deflection of structural beams, thermal expansion

and contraction, elasticity of transmission belts, slippage between belts and pulleys, play within joints of linkages, fabrication tolerances etc. Baheti et al [4] compared the actual positions reached by the mirror of a heliostat to the position commanded by the control unit. By comparing the commanded and actual drive angles, Baheti et al estimated the coefficients of a model representing installation and drive errors. He then used the obtained coefficients to calibrate the same heliostat when it was working in a tracking mode. It should be noted that calibration mode, as coined by Baheti et al, means that the heliostat is under test so that its performance can be recorded. The data of interest when the heliostat is under calibration mode are the sets of achieved mirror angles verses the sets of desired mirror angles. These sets of data were by Baheti et al to estimate coefficients representing installation and drive errors. In tracking mode, according to Baheti et al, the heliostat receives corrected commands from the controller. Corrected commands in this case means that the controller uses the coefficients representing installation and drive errors to correct the drive actuator commands.

In his calibration research, Baheti et al used the sun as his receiver. His research heliostat reflected sunlight back to the sun as though the sun was a mobile receiver. After every 15minutes, he recorded the actual elevation angle of the sun (reference point being the centre of the plane mirror in all cases) verses the elevation angle of the sun as obtained by the heliostat. The elevation angle of the sun as obtained by the heliostat is simply the normal to the plane mirror. The elevation angle of the sun as obtained by the heliostat is not necessarily equal to the actual elevation angle because of inaccuracy of the drive mechanism. By analyzing the two sets of data, Baheti et al came up with coefficients representing installation drive errors.

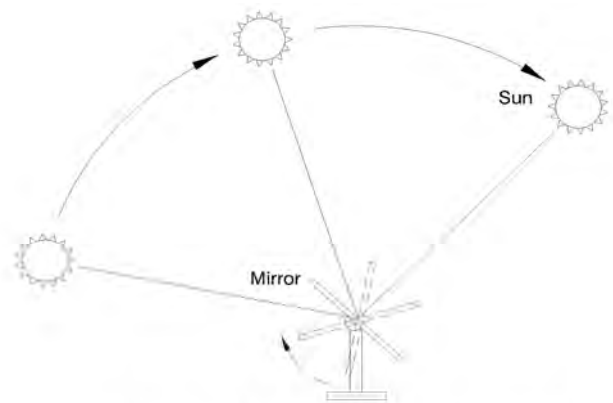

Fig. 8 Shows a heliostat in calibration mode



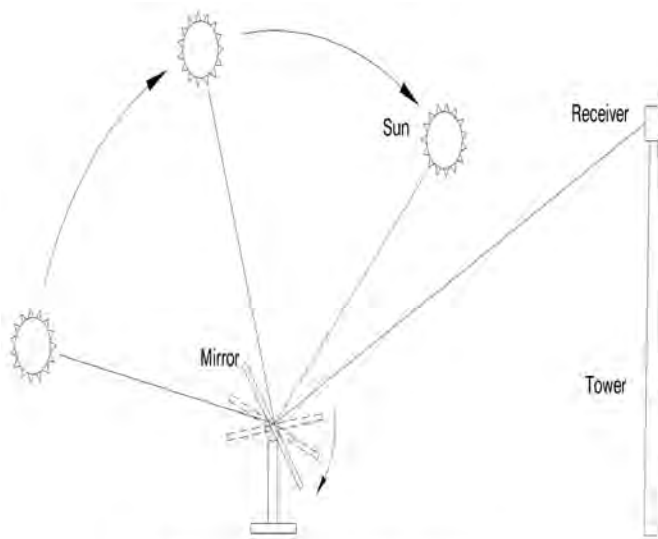

Fig. 9 Shows a heliostat in tracking mode

## V. GAPS AND DRAWBACKS IN HELIOSTAT TECHNOLOGY

### A. COST

Heliostats are the most important cost element of a solar power tower plant. Since they constitute ~50% to the capital cost of the plant it is important to reduce the cost of heliostats as much as possible to improve the economic viability of power towers

[5]. Manuel Romero et al [Romero] identified some avenues of reducing the cost of setting up heliostat fields. Manuel Romero et al advocates for elimination of wires, electric elements and trenches. Romero et al is of the view that a heliostat should be supplied by a small photovoltaic system and it should be communicated to Central Control of the Solar Plant by radio. He identified a number of autonomy:

- Physical autonomy: Removal of trenching and cabling that unbind the heliostat from physical restrictions with a higher freedom of heliostat locations and enlargements of the solar field.
- Power supply autonomy: A PV panel unbinding the heliostat from conventional power grid giving it an un-interrupted power system, UPS.
- Autonomy for calculation: Determination of solar vector and axes positioning during sun tracking unbinding the heliostat from the master control.
- Autonomy for alarms and self-protection: Receiving some autonomous information on weather conditions and being able to handle self-protection and diagnosis.
- Operational autonomy: Capability to perform pre-assigned operational cycles or accepting remote instructions.

### B. PERFORMANCE

The performance of the heliostat field is defined in terms of optical performance which is the ratio of the net power absorbed by the receiver to the power incident normally on

the field. The optical losses of heliostat field take account of losses of the field disposition such as cosine effect, shading and blocking and losses due to other factors such as imperfect mirrors reflectivity, atmospheric attenuation and spillage of the receptor [6].

Although several number of heliostat field arrangement is possible, most of the heliostat field is designed in radial stagger pattern. This arrangement ensures that no heliostat is consigned in front of another heliostat in adjacent rings along a spoke to the tower. Therefore, the beam reflected from heliostats can pass between the neighbours to the receiver. Several studies have indicated that the radial offset disposition is most effective because it reduces the surface field and losses due to atmospheric attenuation. Increasing the number of heliostat can improve the optical efficiency. However, the random distribution of different heliostats in the site creates shadows. These areas significantly reduce the optical performance. To solve this problem it is necessary to make a preliminary study to find the optimal location for the heliostats [7]. Wind loads also affect the performance of heliostats. To make heliostats structurally stable against wind loads introduces heavy structural members on the heliostats. The heliostat moves this dead weight along as it tracks the sun. A lot of energy is spent in this manner. According to Zhiyong Wua, one prevalent idea of cutting the heliostat's cost was to construct it with a bigger reflective surface area. But this design principle brought about the predicament of wind load. For better maintenance, performance and expectation of reducing the wind load acting on the heliostats, the facets were designed with a gap (0–40 mm). Zhiyong Wua et al experimentally and numerically determined the optimum gap size. In their paper, different gap sizes (0–40 mm) between the facets of the heliostats were studied experimentally and numerically. Their results showed that the wind load increases with the increase of gap size (0–40 mm), but the absolute increment of the wind load was very small compared with the overall wind load on the heliostat structure. It is not necessary to take into account the gap size effects on the wind load during the design process of heliostats [8].

Accumulation of dust on the heliostats' mirrors significantly reduce the reflectivity and hence efficiency of the heliostats. Environmental factors e.g. effect on wildlife should also be considered. It has been found that many insect species get attracted to the heliostats' glare and get burnt to death by the high sunlight concentrations. The dead insects attract insect eating birds which in turn attract birds of prey. The use of heliostats in CSP systems therefore has adverse ecological penalty.

## VI. CONCLUSION

Although there are many publications on CSP systems, very few writers have delved into heliostat technology. This could be because heliostats borrow very heavily from the computer discipline and not many writers are well versed with this wide discipline. From the existing drawbacks and gaps, no concrete solution has been suggested for the problem

of dust. The dust problem is inevitable especially in desert environments where CSP systems are quite suitable.

#### REFERENCES

- [1] Techno-economic study of the feasibility of cogeneration of Electricity and Desalinated Sea Water using Concentrated Solar Power. The Cyprus Institute, July 2010.
- [2] Hiromi Nakatani, Development of a Concentrated Solar Power Generation System with a Hot-Air Turbine, Mitsubishi Heavy Industries Technical Review Vol. 49 No. 1 (March 2012).
- [3] Greg Kolb et al, Heliostat Cost Reduction. Elsevier.
- [4] R. S. Baheti, P. F. Scott, Design of self-calibrating controllers for heliostats in solar power a plant.
- [5] Romero M., Marcos M.J., Osuna R. and Fernández V. (2000),” Design and Implementation Plan of a 10 MW Solar Tower Power Plant based on Volumetric-Air Technology in Seville (Spain)”; Proceedings ASME International Solar Energy Conference, Madison, Wisconsin, June 16-21, 2000. Editor: J.D. Pacheco and M.D. Thornbloom, ASME, New York, 2000. ISBN: 0791818799.
- [6] M. Becker, B. Gupta, W. Meinecke, and M.Bohn, Solar Energy Concentrating Systems, C.F. Muller, Heidelberg, Germany, 1995.
- [7] A. Belaid et al, Study of Shading Effects In Heliostats – Tower System Using a Simulink Model.
- [8] Zhiyong Wua et al, An experimental and numerical study of the gap effect on wind load on heliostat.

# Use of the Maturity Method in Quality Control of Concrete: A Review

Allan Mugambi Kaburu, J.W. Kaluli and C. K. Kabubo

**Abstract**—Conventional methods for determining the strength development of in-place concrete require casting, curing and breaking test specimens. The curing conditions of the in-place concrete are, however, rarely the same as those of the test specimens. As a result, there has been a need for test methods to measure the in-place properties of concrete for quality assurance. The concrete maturity method is an approach to quality control that estimates the strength of in-place concrete based on its internal temperature. The thermal history of concrete is used to calculate a quantity called the maturity index. A relationship between concrete strength and the maturity index is then established in the form of a calibration curve. This relationship and the maturity index of the in-place concrete are used to estimate the in-place strength. Although this method continues to evolve, it has inherent limitations. The purpose of this paper is to provide a review of the history, theory, application, benefits and limitations of the maturity method.

**Keywords**—Concrete, Maturity, Quality, Strength

## I. INTRODUCTION

Strength is the most universally used measure for concrete quality [1]. Concrete strength development occurs due to the hydration reaction between cement and water. This increase in strength with age continues as long as unhydrated cement is present, and an appropriate moisture content and temperature are available. For a given concrete mixture, the curing conditions (relative humidity and temperature) are known to have the greatest effect on the rate of strength development.

The determination of concrete strength by testing standard specimens fails to take into account variations in conditions that occur during consolidation and curing of the concrete in a structure [2]. As a result, attempts have been made to use in-place test methods to determine the actual rate of strength gain. These methods include the rebound hammer, ultrasonic pulse velocity, probe penetration, pullout, break-off, and the maturity method.

The maturity method relies on the measured temperature history of concrete to estimate strength development during the curing period, when moisture is available for cement hydration [3]. It provides a relatively simple approach for

estimating the in-place strength of concrete during construction.

Maturity is computed as the product of time and temperature above some datum temperature following concrete casting [2]. Two maturity models are generally used to determine the maturity (time-temperature history) of concrete: the Nurse-Saul function and the Arrhenius equation. The Nurse-Saul function is based on the assumption that the initial rate of strength gain is a linear function of temperature. The Arrhenius equation is used to describe the effect of temperature on the rate of hydration.

The maturity concept requires the development of a mixture-specific calibration curve to establish a relationship between the maturity of concrete and the compressive strength of the concrete. This relationship and the measured maturity of in-place concrete are then used to estimate the in-place strength as illustrated in Fig. 1.

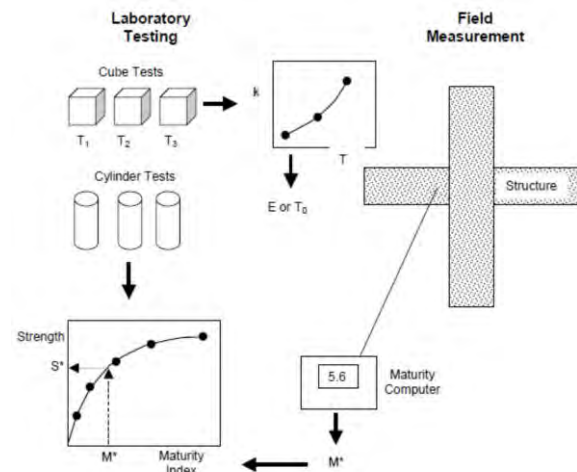

Fig. 1: Application of the maturity method, [3]

## II. BRIEF HISTORY OF THE MATURITY METHOD

The concrete maturity method has been available for more than fifty years [4]. It became an American Society for Testing and Materials (ASTM) standard in 1987 (ASTM C 1074). The National Bureau of Standards (NBS) developed interest in this new approach to quality control after encountering difficulty in using published relative strength development data obtained under constant temperature conditions to obtain a reliable estimate of in-place concrete strength at the time of failure.

Initial research at NBS confirmed that the maturity method could be used to estimate the development of compressive strength, and other mechanical properties of concrete, under

A. M. Kaburu, Department of Civil, Construction and Environmental Engineering, JKUAT (phone: +254724575629; e-mail: allan.mugambi@gmail.com).

J. W. Kaluli, Department of Biomechanical and Environmental Engineering, JKUAT (e-mail: wambuak@gmail.com).

C. K. Kabubo, Sustainable Materials Research and Technology Centre, JKUAT (e-mail: kabcha2001@eng.jkuat.ac.ke).

different curing temperatures [3]. Further research revealed that field-cured specimens experienced different early-age concrete temperatures than lab-cured specimens. As a result, NBS conducted an in-depth study of the maturity method. This research laid the foundation for the development of the standard on the application of the maturity method.

### III. THEORETICAL BACKGROUND OF THE MATURITY METHOD

The origin of the method can be traced to work on steam curing of concrete. It was proposed that the product of time and temperature could be used to account for the combined effects of time and temperature on strength development for different elevated-temperature curing processes [5]. This led to the famous Nurse-Saul maturity function:

$$M = \sum_0^t (T - T_0) \Delta t \quad (1)$$

Where:

$M$  = maturity index, degree Celsius-hour (or degree Celsius-day).

$T$  = average concrete temperature (degree Celsius) during the time interval  $\Delta t$ .

$T_0$  = datum temperature (usually taken to be 10°C).

$\Delta t$  = time interval (hour or day).

The index computed by equation (1) was referred to as the maturity. This equation is based on the assumption that the initial rate of strength gain is a linear function of temperature.

However, it was realized that this approximation may not be valid when curing temperatures vary over a wide range [5]. A new function was proposed. It was based on the Arrhenius equation, which is used to describe the effect of temperature on the initial rate of the hydration reactions in concrete. This function allowed the computation of the equivalent age of concrete at a reference temperature as follows:

$$t_e = \sum_0^t e^{\frac{-E}{R} \left( \frac{1}{T} - \frac{1}{T_r} \right)} \Delta t \quad (2)$$

Where:

$t_e$  = equivalent age at the reference temperature (hour or day).

$E$  = apparent activation energy (J/mol).

$R$  = universal gas constant = 8.314 J/mol-K.

$T$  = average absolute temperature of the concrete during interval  $\Delta t$  (degrees Kelvin).

$T_r$  = absolute reference temperature (degrees Kelvin).

The actual age of the concrete is converted to its equivalent age, in terms of strength gain, at the reference temperature. Although comparative studies showed that this new maturity function was superior to the Nurse-Saul function, ASTM C

1074 permits the user to express the maturity index using either the temperature-time factor based on the Nurse-Saul function or equivalent age based on the Arrhenius equation. Further investigation is, however, required to determine the factors that affect the Arrhenius equation in the field [6].

### IV. APPLICATION OF THE MATURITY METHOD

The standard practice on the use of the maturity method to estimate in-place strength is based on ASTM C 1074. It requires the following steps:

1. Determining the datum temperature or activation energy for the specific concrete to be used in construction—The datum temperature ( $T_0$ ) in equation (1) is the temperature below which no strength gain of concrete takes place [7]. The procedure for determining the datum temperature involves curing mortar cubes (made with the materials to be used in construction) at three temperatures. Two of the curing temperatures should be the minimum and maximum curing temperatures expected for the in-place concrete. The third temperature should be midway between the extremes. The cubes are then tested for compressive strength at regular time intervals.
  - i. Curing mortar specimens at different constant temperatures.
  - ii. Determining compressive strengths at regular age intervals.
  - iii. Determining the value of the rate constant at each temperature by fitting a strength-age relationship to each set of strength-age data.
  - iv. Plotting the natural logarithms of the rate constants versus the inverse of the curing temperature (in Kelvin).
  - v. Determining the best-fit Arrhenius equation to represent the variation of the rate constant with the temperature.
2. Determining the relationship between compressive strength and the maturity index—The constituents and mixture proportions of the concrete to be used in construction are used to prepare cylindrical concrete specimens. These specimens are prepared according to the usual procedures for making and curing test specimens in the laboratory [3]. Temperature sensors are embedded at the centers of at least two cylinders. The sensors are connected to temperature recording devices.
 

The specimens are cured in a water bath or in a moist curing room and compression tests are performed on at least two specimens at ages of 1, 3, 7, 14, and 28 days. At the time of testing, the maturity is evaluated according to equation (1) or equation (2) and the average maturity value is recorded.

The average compressive strength is plotted as a function of the average maturity index. A best-fit smooth

curve is then drawn through the data. Regression analysis may also be used to determine the best-fit curve for an appropriate strength-maturity relationship. The resulting curve is used to estimate the in-place strength of that concrete mixture.

3. Measuring the in-place maturity index and estimating the in-place strength—Temperature sensors are placed in the fresh concrete and temperature recording devices are activated as soon as is practicable after placement. The sensors should be installed at locations in the structure that are critical in terms of exposure conditions and structural requirements, especially when the strength estimates are to be used for timing the start of critical construction operations [3].

When a strength estimate is desired, the maturity index is first evaluated from the temperature record. Compressive strengths at the locations of the sensors are then estimated using the maturity values and the previously established strength-maturity relationship.

#### V. BENEFITS AND LIMITATIONS OF THE MATURITY METHOD

The use of the maturity method provides a few advantages when compared to conventional quality control specimens for strength verification [9]. Besides providing a better representation of in-place concrete strength gain, the maturity method enables in-place strength measurements at any time and as many times as necessary until the desired strength is achieved. Because of this, better timing can be applied to strength-dependent construction activities such as post-tensioning, removing formwork and backfilling. The cost savings resulting from this improved timing, as well as the reduced number of specimens required when the maturity method is utilized appropriately, are considerable.

Although the maturity concept continues to evolve, it still has inherent limitations [10]. These limitations as outlined in ASTM C 1074-74 include:

1. Concrete must be maintained in a condition that permits cement hydration—Concrete must be properly cured so as to maintain increase in strength with age. This means that a satisfactory moisture content and temperature must be maintained.
2. The method does not take into account the effects of early age concrete temperature on the long-term ultimate strength—For normal-strength portland cement concrete, higher early-age curing temperature yields lower strength at a later age compared with an initial lower early-age curing temperature. This is the main limitation of the maturity method.
3. The method needs to be supplemented by other indicators of the potential strength of the concrete mixture—ASTM C 1074 requires verification of the potential strength of the in-place concrete before performing critical operations, such as formwork removal or post-tensioning [3]. This is because there is no assurance that the in-place concrete has the correct mixture proportions. Methods for verification of concrete strength include:

- i. other in-place tests that measure the actual strength of in-place concrete;
- ii. early-age compressive strength tests on standard-cured specimens prepared from samples of in-place concrete; or
- iii. compressive strength tests on specimens molded from samples of in-place concrete and subjected to accelerated curing.

#### VI. CONCLUSION

Proper application of the maturity method as a means for concrete quality control allows construction operations to be performed safely at the earliest possible time, resulting in reduced construction time and cost. However, the limitations of the method need to be understood in order to prevent catastrophic failure of concrete structures.

#### REFERENCES

- [1] Kosmatka, S. H., Kerkhoff, B., and Panarese, W. C. (2003). *Design and Control of Concrete Mixtures*. (14th ed.). Skokie, Illinois: Portland Cement Association.
- [2] Naik, T. R. (1992). Maturity of Concrete: Its Applications and Limitations. *Advances in Concrete Technology* CANMET, CBU-1992-27, REP-86.
- [3] Carino, N. J., and Lew, H. S. (2001, May 21-23). *The Maturity Method: From Theory to Application*. Proceedings of the 2001 Structures Congress & Exposition, Washington, D.C., American Society of Civil Engineers, Reston, Virginia, Peter C. Chang, Editor, 2001, 19 p.
- [4] Bagheri-Zadeh, S.-H., Kim, H., Hounsell, S., Wood, C. R., Soleymani, H., and King, M. (2007). Field Study of Concrete Maturity Methodology in Cold Weather. *Journal of Construction Engineering and Management*, Vol. 133, No. 11: 827-835.
- [5] Carino, N. J. (2008). Nondestructive test methods: Methods to estimate in-place strength. In Edward G. Nawy (2<sup>nd</sup> ed.), *Concrete construction engineering handbook*. (pp. 894-895). Boca Raton: CRC Press.
- [6] Jung, J.-S., and Cho, Y.-H. (2009). Comparison between Nurse-Saul and Arrhenius equations. *Canadian Journal of Civil Engineering*, 36: 514-518.
- [7] Ghosh, S. K. (2008). Construction loading in high-rise buildings: Properties of concrete at early ages. In Edward G. Nawy (2<sup>nd</sup> ed.), *Concrete construction engineering handbook*. (pp. 307). Boca Raton: CRC Press.
- [8] Brooks, A. G., Schindler, A. K., and Barnes, R. W. (2007). Maturity Method Evaluated for Various Cementitious Materials. *Journal of Materials in Civil Engineering*, Vol. 19 (12): 1017-1025.
- [9] Myers, J. J. (2000, September 25-27). *The Use of Maturity Method as a Quality Control Tool for High Performance Concrete Bridge Decks*. PCI / FHWA / FIB International Symposium on High Performance Concrete.
- [10] Kim, T., and Rens, K. L. (2008). Concrete Maturity Method Using Variable Temperature Curing for Normal-Strength Concrete Mixes. II: Theoretical Study. *Journal of Materials in Civil Engineering*, Vol. 20, No. 12: 735-741.

# Effect of Exhaust Gas Recirculation on Performance and Emission Characteristics of a Diesel Engine

M. Hawi, R. Kiplimo, H. Ndiritu and E. Munyao

**Abstract**— The exhaust system of a single cylinder, four stroke Direct Injection Compression Ignition (DIC) engine was modified to allow for exhaust gas recirculation (EGR) in order to investigate its effect on performance and emission characteristics of the engine. The EGR system was developed and tested with EGR rates of 0%, 10%, 20% and 30%. The effect on performance parameters of brake specific fuel consumption, brake power and brake thermal efficiency was studied. Emissions of carbon monoxide, unburned hydrocarbon and carbon dioxide were also recorded. The performance and emission characteristics of the engine under EGR were compared with those of the engine operation without EGR. The results showed that EGR leads to a decrease in specific fuel consumption and increase in brake thermal efficiency. With increase in percent (%) of EGR, the BSFC decreased by up to 10.71% at quarter load and decreased by up to 6.76% at full load. The percentage increase in brake thermal efficiency was up to 12.01% at quarter load and up to 14.52% at full load. On the other hand, the brake power decreased by up to 6.13%. Exhaust emissions of HC and CO, both increased with EGR by up to 26.57% and 30.48% respectively. Emission of CO<sub>2</sub> however, decreased with EGR.

**Keywords**— DIC engine, EGR, engine performance, exhaust emission.

## I. INTRODUCTION

THE use of compression ignition (CI) engines as power source for automobiles is common in many parts of the world due to their high thermal efficiency, excellent fuel economy and low regulated emissions of unburned hydrocarbon (HC), carbon monoxide (CO) and carbon dioxide (CO<sub>2</sub>) compared to those of spark ignition (SI) engines [1]. However, diesel engines generally exhaust a larger amount of particulate matter (PM) and nitrogen oxide (NO<sub>x</sub>) pollutant emissions than those of gasoline engines [1, 2]. High NO<sub>x</sub> and PM emission from diesel engines remains a major problem in the pollution aspect and in order to reduce NO<sub>x</sub> emission levels, some external engine features can be applied, such as

Exhaust Gas Recirculation (EGR) or after-treatment systems.

EGR is a technique used to reduce NO<sub>x</sub> emission in which part of exhaust gas is recirculated and taken back to the combustion chamber along with the intake air [3], [4]. Exhaust consists of CO<sub>2</sub>, N<sub>2</sub> and water vapour, mainly and it acts as a diluent to the combustion mixture, reducing oxygen concentration while increasing specific heat of incoming charge. This ultimately reduces peak combustion temperature under which NO<sub>x</sub> is generated. The specific heat of the exhaust gas is much higher than fresh air; hence EGR increases the heat capacity (specific heat) of the intake charge, thus decreasing the temperature rise for the same heat release in the combustion chamber [5]. NO<sub>x</sub> formation is a highly temperature dependent phenomenon and takes place when the temperature in the combustion chamber exceeds 2000 K. Formation of NO<sub>x</sub> is almost absent at temperatures below 2000 K [5]. Therefore, in order to reduce NO<sub>x</sub> emissions in the exhaust, it is necessary to keep peak combustion temperatures under control. EGR has also the advantage of resupplying of unburned hydrocarbons, giving them an opportunity to re-burn [6], [7]. Depending on the engine operating conditions, these systems divert 5-30% of an engine exhaust stream back to the combustion chamber [8].

Many researchers have investigated the effect of EGR on performance and emission characteristics of diesel engines, with most of the research work considering EGR rates of up to 15% [8, 9]. There has however been some variation in the results of various researchers on performance and emission characteristics of the diesel engine under EGR. There is need therefore, to investigate the effect of higher EGR rates on engine performance and emission characteristics. More research also needs to be done to clarify the differences in some of the research findings. A. Kumar *et al.* [5] studied the effect of EGR on exhaust gas temperature and exhaust opacity in CI engines. They found that the exhaust gas temperature reduces drastically by employing EGR. They also reported that thermal efficiency and brake specific fuel consumption were not affected significantly by EGR. Another research by K. Rajan *et al.* however showed that EGR causes a significant decrease in BSFC and increase in BTE [9]. The research by K. Rajan *et al.*, also showed that unburnt hydrocarbon (HC) increases with increase in load and EGR rate because of lower oxygen content available for combustion, that is, lower excess oxygen concentration results in rich mixture which results in incomplete combustion and higher hydrocarbon emission

M. Hawi, Department of Mechanical Engineering, JKUAT (corresponding author phone: +254 725 045 042; e-mail: mhawi@jkuat.ac.ke).

H. Ndiritu, Department of Mechanical Engineering, JKUAT (e-mail: hndiritu@eng.jkuat.ac.ke).

R. Kiplimo, Department of Marine Engineering, JKUAT (e-mail: kiprob@eng.jkuat.ac.ke).

E. Munyao, Department of Marine Engineering, JKUAT (e-mail: emunyao@jkuat.ac.ke).

while research by Jan-Ola Olsson et al shows decrease in HC emission with EGR [10]. Such differences need to be harmonized through further research.

When exhaust gas recirculation is applied, it is also important that its effect on the overall performance of the engine be investigated. In the current study, experiments were done on a single cylinder 4 stroke diesel engine by varying load on the engine and percentage of exhaust gas recirculated. The effect of EGR on Brake Power, Brake Thermal Efficiency (BTE), Brake Specific Fuel Consumption (BSFC) and exhaust emissions of CO, HC and CO<sub>2</sub> was studied.

## II. EXPERIMENTAL PROCEDURE AND EQUIPMENT

### A. The Experimental Set up

The engine used for this study is a single cylinder four stroke Direct Injection (DI) diesel engine. It is water cooled, naturally aspirated constant speed compression ignition engine whose major specifications are shown in Table 1. The engine was coupled to a hydraulic dynamometer through which load was applied by increasing the water supply to rotor blades via a centrifugal pump. The engine was tested at 0, 25, 50, 75 and 100 percent brake load conditions. The experimental apparatus consisted of the test engine, the dynamometer, the fuel supply and control systems, the exhaust emission analyzer and temperature measurement system as shown in Fig. 1. The properties of the diesel fuel used are shown in Table 2.

TABLE I  
ENGINE SPECIFICATIONS

Specification	Value	
1	Number of cylinders	1
2	Number of strokes	4
3	Number of holes in injector	3
4	Rated power (kW)	7.5
5	Speed (rpm)	1500
6	Compression ratio	16.5:1
7	Injection pressure (bar)	200
8	Injection timing ( <sup>o</sup> btdc)	23
9	Cylinder capacity (cc)	950
10	Fuel consumption (g/kWh)	251
11	Combustion system	Direct injection

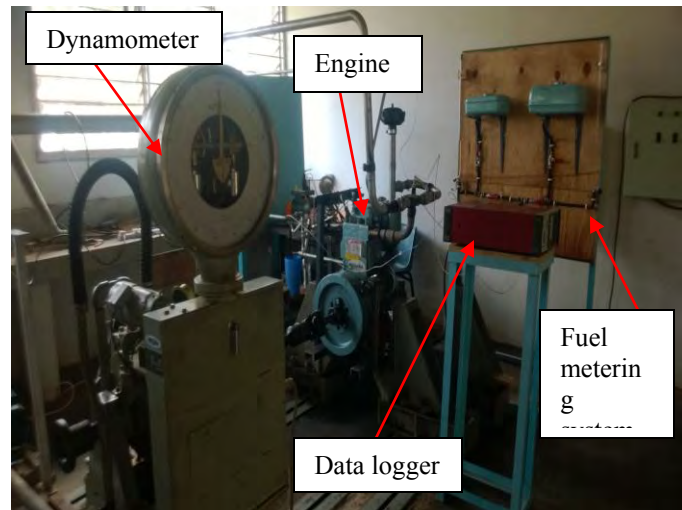

Fig. 1 Experimental set up

TABLE 2  
FUEL PROPERTIES OF DIESEL

Quantity	Value	
1	Density (kg/m <sup>3</sup> )	837
2	LHV (kJ/kg)	42,000
3	Cetane Index	52
4	Flash point (°C)	76
5	Auto Ignition Temperature (°C)	230-280
6	Stoichiometric A/F Ratio	14.7
7	Chemical Formula	C <sub>10.8</sub> H <sub>18.7</sub>
8	Carbon	84-87
9	Hydrogen	33-16

### B. Experimental Procedure

The engine load was controlled using the hydraulic dynamometer while the exhaust gas was analyzed by Horiba MEXA-544GF emission analyzer. The dynamometer reading (load), engine speed, fuel consumption and exhaust gas temperature were recorded during experiments. Exhaust gases were analyzed on line by the emission analyzer in which HC, CO and CO<sub>2</sub> were measured. A portable Laser type digital tachometer - RS 445-9557 was used to measure the engine speed at all operating conditions. Thermocouples were fixed at the exhaust manifold and at engine coolant inlet and outlet to the engine to measure the temperature of exhaust gas, temperature of cooling water at entry to the engine and temperature of cooling water at exit from the engine respectively. The diesel fuel was pressurized by the high pressure injector system and the flow rate measured by the fuel flow meter.

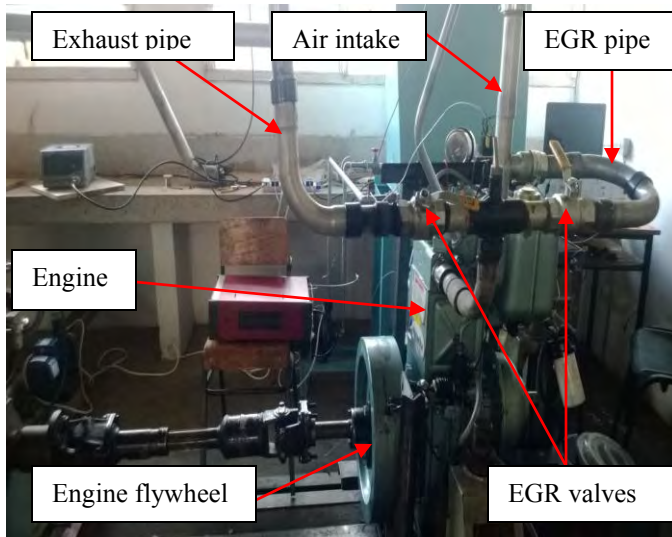

Fig. 2 The exhaust gas recirculation system

The EGR system used in this research is shown in Fig. 2. The investigation of the effect of EGR on engine performance was started by running the engine at a rated speed of 1500 rpm till the warm-up period was reached. The engine was then loaded in terms of 0%, 25%, 50%, 75% and 100% corresponding to the loading conditions of no load, quarter load, half load, three quarter load and full load respectively. At each load, the engine was run with different EGR conditions. The exhaust gases were tapped from exhaust pipe and directed to the air inlet through the EGR system, consisting of two control valves and a graduated flat metal plate to indicate the degree of valve opening. After attaining the steady state condition, observations were made for various parameters such as exhaust gas temperature, fuel consumption, torque and actual engine speed which were then recorded at various loads. Exhaust emissions of CO, CO<sub>2</sub> and HC were recorded simultaneously by the exhaust gas analyzer.

### C. Performance Evaluation of the Engine

The engine was tested at the engine speed 1500 rpm and five loading conditions (0%, 25%, 50%, 75% and 100%). Each test was conducted with four replications. During each test, the engine load, engine speed and fuel consumption were measured. The observed data were utilized to calculate the engine brake power, specific fuel consumption and thermal efficiency.

## III. RESULTS

The data collected from experiments were used to draw graphs showing variation of various performance parameters with engine load. The experimental results were as shown in the graphs (Fig. 3 to Fig. 8).

### A. Brake Specific Fuel Consumption

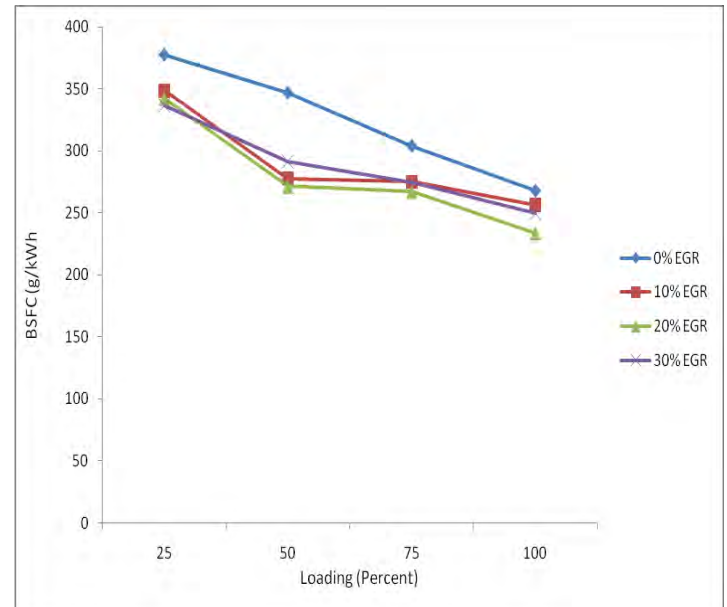

Fig. 3 Variation of BSFC with load

Fig. 3 shows variation of BSFC with load. It shows that BSFC decreases with load for all operating modes. It also shows that the brake specific fuel consumption decreases with increase in EGR. The decrease in BSFC with EGR is due to increase in intake charge temperature which increases the rate of combustion of the fuel, hence improving BSFC i.e. BSFC decreases. EGR led to a reduction in BSFC of up to 10.7% at quarter load and a reduction of up to 6.76% at full load.

### B. Brake Thermal Efficiency

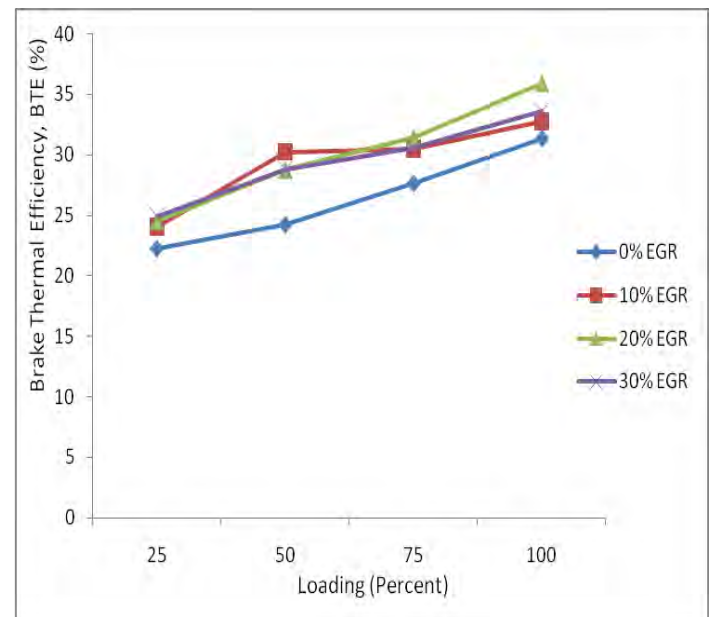

Fig. 4 Variation of BTE with load



Fig. 4 shows that the brake thermal efficiency increases with increase in engine load for all operating modes. The BTE increases also with the amount of exhaust gas that is recirculated. The reason for increase in BTE with EGR is due to re-burning of HC that enters combustion chamber with the recirculation of exhaust gases and also EGR increases intake charge temperature which increases the rate of combustion of the fuel. The maximum increase in BTE at quarter load due to EGR was 12.01% with the maximum increase at full load being 7.28%.

### C. Brake Power

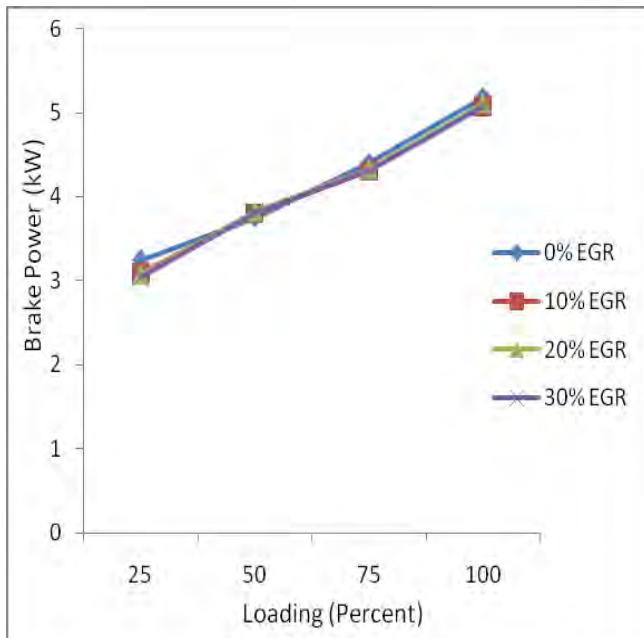

Fig. 5 Variation of brake power with load

Fig. 5 shows a linear increase in power output of the engine with increase in load, from no load to full load for all conditions of EGR. The figure shows that there was no significant change in engine power output with EGR. The decrease in brake power at quarter load was up to 6.13% while at full load the decrease recorded was up to 1.89%.

### D. Carbon monoxide emission

Fig. 6 shows the variation of CO emissions with percentage of EGR at various engine loads. It shows that emission of CO increases with increase in load for all operating modes of EGR. It was also found that with increase in percentage of EGR, CO increases.

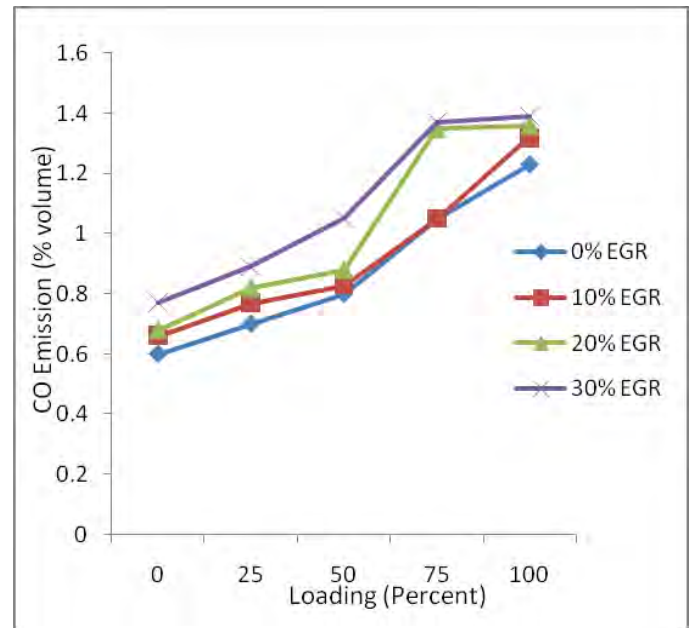

Fig. 6 Variation of CO emission with load

The increase in emission of CO at no load was up to 16.67% while at full load an increase of up to 13.01% was recorded. The deficiency of oxygen with the increase in EGR percentage can be attributed to the increase in CO emission for EGR. This clearly shows that though EGR has the potential of reducing emission of NO<sub>x</sub>, it increases CO emission. It therefore implies that a trade-off has to be reached between emission of CO and NO<sub>x</sub> if EGR is to be applied.

### E. Unburned Hydrocarbon (HC) Emission

Fig. 7 shows the effect of EGR on HC emissions at various engine loads. It can be seen from the figure that HC emission increases with engine load for all operating modes of EGR. HC emissions increase also with increase in percent EGR. At no load, there was an increase in HC emission of up to 20% while at full load the increase was up to 28.6%. The increase in HC emission with EGR is as a result of increase in the CO<sub>2</sub> content of the inducted mixture instead of fresh-air, leading to incomplete combustion of the fuel in the combustion chamber. EGR leads to increase in HC emission implying that if EGR is applied as a means of reducing NO<sub>x</sub> emission, the effect on other emissions must be considered.

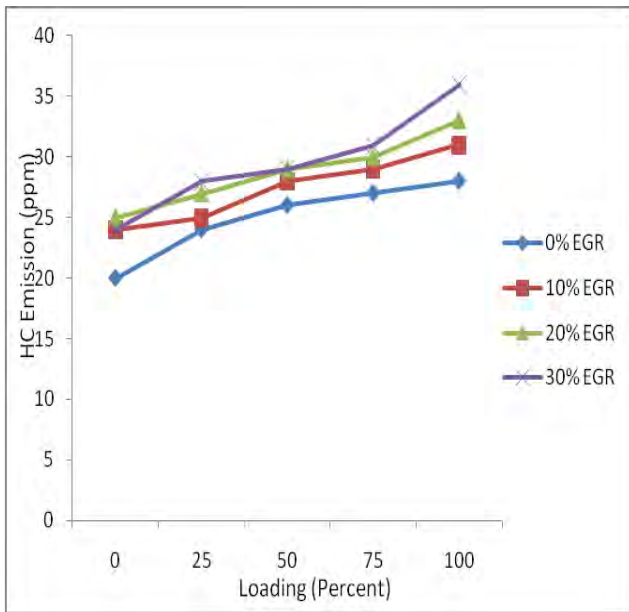

Fig. 7 Variation of HC emission with load

#### F. Carbon dioxide Emission

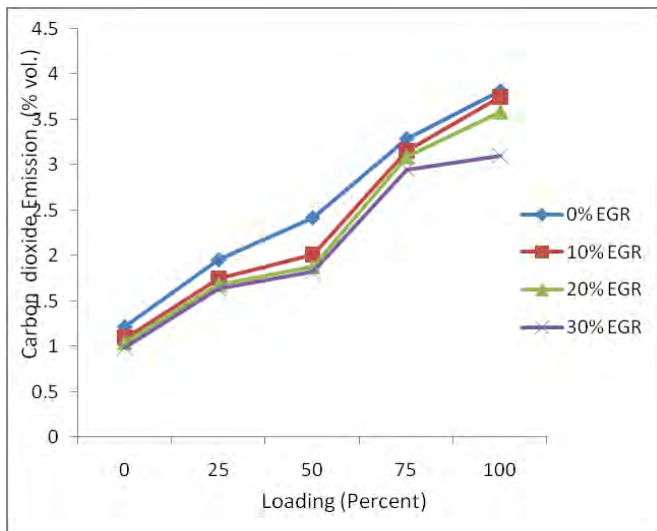

Fig. 8 Variation of CO<sub>2</sub> emission with load

From Fig. 8, emission of carbon dioxide increases with engine load for all modes of EGR while the same decreases slightly with EGR from 10% to 30% EGR. The decrease in CO<sub>2</sub> emission at no load was up to 19.43% while at full load the decrease was up to 18.82%. This is as a result of substitution of some of the fresh air with exhaust gas leading to decrease in CO<sub>2</sub> which is a product of complete fuel combustion. This further shows that EGR has a limitation in relation to incomplete combustion of the fuel, which results from displacement of the air needed for combustion.

#### IV. CONCLUSION

The study was conducted to investigate various effects of EGR on the performance and exhaust emission characteristics of a single cylinder four stroke DI diesel engine under various experimental conditions. The following conclusions were drawn from the analysis:

- 1) The effect of EGR on engine brake power is not very significant, though brake power reduces slightly with EGR (by up to 6.13%)
- 2) The BSFC decreases (improves) with EGR (up to about 20% EGR) while BTE increases with the same for all loading conditions
- 3) Both CO and HC emissions increase with EGR due to substitution of fresh air needed for combustion with exhaust gases hence leading to incomplete combustion of fuel.
- 4) Emission of CO<sub>2</sub> decreases with EGR due to incomplete combustion of fuel.

#### ACKNOWLEDGEMENT

The authors gratefully recognize the support from Japan International Corporation Agency (JICA) in providing research equipment used in this study. The authors also thank JKUAT for funding this research and for providing laboratory facilities for conducting experiments.

#### NOMENCLATURE

DICI-Direct Injection Compression Ignition  
DI-Direct Injection  
CI-Compression Ignition  
SI-Spark Ignition  
BTE-Brake Thermal Efficiency  
BSFC-Brake Specific Fuel Consumption  
EGT-Exhaust Gas Temperature  
PM-Particulate Matter  
CO-Carbon monoxide  
CO<sub>2</sub>-Carbon dioxide  
HC-Hydrocarbons  
NO<sub>x</sub>-Oxides of Nitrogen

#### REFERENCES

- [1] R. L. McCormick, C. J. Tennant, R. R. Hayes, S. Black, J. Ireland, T. McDaniel, A. Williams, M. Frailey, and C. A. Sharp, "Regulated emissions from biodiesel tested in heavy-duty engines meeting 2004 emission standards," tech. rep., SAE Technical Paper, 2005.
- [2] S. H. Yoon, S. H. Park, and C. S. Lee, "Experimental investigation on the fuel properties of biodiesel and its blends at various temperatures," *Energy & Fuels*, vol. 22, no. 1, pp. 652-656, 2007.
- [3] M. S. Rathore and P. Ghodasara, "Prediction on Reduction of Emission of NO<sub>x</sub> in Diesel Engine using Bio-diesel Fuel and EGR (Exhaust Gas Recirculation) System," *International Journal of Mechanical Engineering*, vol. 1, no. 1, pp. 18-25, 2009.
- [4] Z. Salhab, "Effect of Exhaust Gas Recirculation on the Emission and Performance of Hydrogen Fueled Spark-ignition Engine," vol. 12, no. 2, pp. 1-6, 2012.
- [5] V. Manienyan and S. Sivaprakasam, "Experimental Analysis of Exhaust Gas Recirculation on DI Diesel Engine Operating with Biodiesel," *International Journal of Engineering and Technology*, vol. 3, no. 2, pp. 129-135, 2013.

- [6] P. Saichaitanya, K. Simhadri, and G. Vamsidurgamohan, "Impact of Cold and Hot Exhaust Gas Recirculation on Diesel Engine," *International Journal of Engineering Research and Applications*, vol. 3, no. 5, pp. 430-434, 2013.
- [7] N. R. Kumar, Y. M. C. Sekhar, and S. Adinarayana, "Effects of Compression Ratio and EGR on Performance, Combustion and Emissions of Direct Injection Diesel Engine," *International Journal of Applied Science and Engineering*, vol. 11, no. 1, pp. 41-49, 2013.
- [8] A. K. Agrawal, S. K. Singh, S. Sinha, and M. K. Shukla, "Effect of EGR on the exhaust gas temperature and exhaust opacity in compression ignition engines." 2004.
- [9] K. Rajan and K. R. Senthikulmar, "Effect of Exhaust Gas Recirculation (EGR) on the Performance and Emission Characteristics of Diesel Engine with Sunflower Oil Methyl Ester," *Jordan Journal of Mechanical and Industrial Engineering*, vol. 3, no. 4, pp. 306-311, 2009.
- [10] J. Olsson, P. Tunestål, J. Ulfvik and B. Johansson, "The Effect of Cooled EGR on Emissions and Performance of a Turbocharged HCCI Engine", Tech. Report, Society of Automotive Engineers, 2003.

# Impact of training in manufacturing skills on growth of smallholder agro-processing industry in Bureti Sub county, Kericho County, Kenya

Odoyo J. Bittar, Raphael O. Nyonje and Adhiambo Rawago-Odoyo

**Abstract** - The desire to have agricultural products get better competitiveness in both domestic and international markets has forced many developing countries to focus on expanding small-scale rural processing. Building manufacturing skills capacity of small agricultural producers on agro-product processing has emerged as a major strategy to realize this goal. Notably, agro-producers with high levels of awareness on manufacturing knowledge and skills are more pre-disposed to adopting agro-processing as a strategy of making their products penetrate markets and survive competition. This study sought to establish the impact of manufacturing skills training on growth of smallholder agro-processing industry using a cross-sectional descriptive design. A sample of 196 respondents comprising of 183 smallholder farmers drawn from agro-processing groups, 3 agro-processing individuals and 10 agricultural experts was used and distributed proportionately across 4 geographical sampling clusters using Bowley's proportional formula. The main instruments used were structured interview schedule and questionnaire which were analyzed using frequencies and percentages. Inferential statistics such as chi-square ( $\chi^2$ ) was used to analyze interrelationships. The study findings revealed that frequency of manufacturing skills information exchanges between agricultural experts and farmers caused a significant influence on the number of agro-processing businesses established by small-scale farmers. For instance the frequency of visits to farmers by agricultural experts (chi-square  $p$ -value = 0.009,  $p < 0.05$ ) and frequency of farmers' manufacturing skills training sessions (chi-square  $p$ -value = 0.003,  $p < 0.05$ ) both led to increase in number of agro-processing businesses set up in Bureti Sub-County. Similarly, the study established that different types of agro-manufacturing skills passed to farmers had positive, though varied, impacts on the number of smallholder agro-processing businesses established. It was concluded that the degree of access to agro-manufacturing skills training leads to positive growth in number of agro-processing businesses set up by smallholder entrepreneurs. It was therefore recommended that education policy makers should introduce basic functional agro-manufacturing skills education at lower rungs of educational hierarchy as a way of creating life-skills preparedness among potential primary and secondary graduates who may not transit to tertiary institutions.

**Key Words:** Bureti-Kenya, Growth in number, Manufacturing training, Smallholder agro-processing industry

## I. BACKGROUND OF THE STUDY

Agro-processing industry is one of the drivers of agricultural sector modernization efforts in a number of developing

countries [1]. It is globally recognized for its capacity to reduce poverty, particularly in the developing world [2]; [3]. This role of agro-processing industry is underscored by [4] through a statement that "*the sector is being looked upon as key to the achievement of global commitments on the Millennium Development Goal number one (MDG1) on poverty and hunger*". Respective studies in India and Zimbabwe by [5] and [6] cite the factors of agro-manufacturing skills and competence as major determinants of either success or failure of agro-processing industry. The problem of poverty and food security is therefore related in a significant measure to the role manufacturing skills play in the growth of agro-processing industry. Through its contribution to the efficient processing and distribution of agricultural products, acquisition of manufacturing skills offers opportunities to poor smallholder farmers to escape the cycle of food and economic poverty.

In many countries agro-processing industry represents an important component of the overall economic activity and trade, as well as being a sizeable source of employment and income and thus, access to food [7]. A study by [8] on the relevance of access to manufacturing skills by small-scale sector to the overall economic and industrial growth in APEC countries established that micro and small enterprises (MSEs) could not grow on-their-own without external assistance because they lacked technical, managerial and marketing skills. This finding is confirmed by [3] when he found that "*the exclusion of local people by the Dutch colonial rule from taking part in business activities denied Indonesians the benefit of transfer of agro-manufacturing skills*" and this led to stagnation in growth of MSEs. The work of [8] shows the importance of manufacturing skills in MSEs to growth of economy in terms of number of firms and their contribution to overall employment. For the majority of APEC economies such as Malaysia, Russia, Brunei, Canada, Singapore, Indonesia and Philippines the percentage share of MSEs out of the total number of enterprises ranged between 90 and 100 percent. In total there were an estimated 6 million MSEs in APEC, which employed about 2.5 billion people and commanded a share of exports of 30 percent of a total value of US\$ 3 trillion [8]. These sets of data indicate that access to manufacturing skills affect the industry growth factors differently in the different countries.

In India, [5] established that providing agro-manufacturing skills to entrepreneurs not only increased the number of agro-processing units established but also enabled the owners to run them effectively and economically. Training

Odoyo J. Bittar, Department of Extra Mural Studies, University of Nairobi  
(Email: odojobittar@gmail.com, Tel: 0717- 329295)  
Nyonje O. Raphael, Department of Extra Mural Studies, University of Nairobi,  
(Email: myonje@yahoo.com , Tel : 0722 - 982964)

on manufacturing skills was found to be important in equipping the entrepreneurs with capacity to produce quality finished products and therefore, better product competition in the market.

In Africa, a survey by [9] found that smallholder farmers become deeply vulnerable to economic shocks because of lack of access to markets. The experience of [9] however shows that, with access to appropriate agro-processing skills and financial support, majority of Africa's small-scale producers are able to increase their incomes in ways that are economically sustainable. For instance, in Uganda's Nakasongola District access to agro-manufacturing skills by some 500 smallholder farmers helped them to exit chronic cycle of dependence on food aid. The acquired agro-manufacturing skills enabled the farmers to set up two new cassava processing facilities which created market to cassava farmers through backward linkage with production, and as a result food security for the smallholder rural families increased drastically [9]. In Zimbabwe 26 case studies conducted by [10] concluded that small-scale fruit and vegetable processing has the potential to provide improved returns to horticultural producers as long as appropriate processing equipment, processing skills, packaging material, and marketing information are made available.

According to [10] value added capability (VAC) model is the most pragmatic concept for measuring the contribution of agro-manufacturing skills to agro-industrial growth. Ref [10] emphasizes that for processing of raw materials to occur in any manufacturing unit, there must be a technological capability whose critical components includes the manufacturing skills of employees. According to VAC model existence of manufacturing skills helps in the establishment and instituting effective operation of agro-processing enterprises.

Some of the critical factors required in increasing the level of manufacturing skills among agro-processing business operators are training on technical skills and continual dissemination of manufacturing knowledge. Effective dissemination of manufacturing skills depends on availability of sufficient number of technical specialists to offer training and advisory services to agro-processors. The level of agro-processing skills and information outreach to smallholder farmers is determined by the ratio of technical advisors to farmers or agro-processors [11]. High ratios imply high levels of manufacturing skills dissemination and vice versa. Agro-producers with high levels of awareness on manufacturing knowledge and skills are more pre-disposed to adopt agro-processing as a strategy of making their products penetrate markets and survive competition with agro-products from developed countries. Ref [12] while studying success cases for rural development in agro-processing in South Africa concluded that adoption of technology depends, in the first instance, on degree of change in attitude occasioned by the level of knowledge and skills acquired and, secondly, on the resource capability of the smallholder processor. Thus, knowledge and skills are necessary but not sufficient conditions for adoption of any new technology such as agro-

processing. The relationship that exists between manufacturing skills dissemination and the growth of agro-processing businesses or units, then, can partly be seen in the context of the number of agro-producers who have adopted agro-processing technology as a result of knowledge and skills gained from agro-processing training and advisory services. The rate of agro-processing technology adoption thus determines the rate of establishment of agro-processing units, which is one of the indicators of growth of the sector.

Farming in developing economies such as Kenya, though still far from the status in the developed world is increasingly becoming commercialized due to the influences of globalization and the spectre of rising unemployment [12]; [13]. Developing countries, in their effort to stem the problem of rising unemployment especially among the youth, are re-orienting their approach to agriculture sector development from purely food provision to agri-business [14]; [15]; [16]. Agro-manufacturing skills are, in this way, avenues of growing the agro-processing industries in the developing countries like Kenya to create employment to stem the problem of under-employed young generation. According to [17] training of farmers and small-scale agro-entrepreneurs on agro-processing skills can build their capacity in fulfilling manufacturing operations of the businesses. Agro-manufacturing skills are critical in ensuring efficiency and effectiveness of production processes which together contribute to business health. Ref [17] found that farmers who had received basic training in agro-processing skills from extension service providers executed their production processes better and recorded higher net returns compared to untrained category. Well trained agro-entrepreneurs are the most likely to manage their businesses to higher profitability levels in comparison to enterprises run by untrained people. Ref [16], in their intriguing study; "*Is there a future for small-scale farms?*" found making small-scale farms profitable through technology and intensification the only option for future survival. They warn that future small-scale farmer must be one who keeps abreast of new skills to make micro-scale farming profitable. The competition to gain space in future farming environment is thus about knowledge and skills to guarantee sustainable profitability levels.

## II. STATEMENT OF THE PROBLEM

Agriculture remains the lifeblood of many countries as demonstrated by its dominance in a large number of economies across the globe. However, agriculture is still largely practised as subsistence occupation with the resulting products traded in primary form. According to [18] primary agriculture alone can no longer provide reliable livelihoods for the poor rural households that solely depend on it. In Africa, for instance, the burden of providing additional sources of survival to the over 65% of the continent's population that depends solely on agriculture is being placed on agro-processing [9]. In Kenya the focus of growth in agriculture sector over the last decade has been put on agro-processing as the stimulant of economic momentum [19]. However, agro-processing sector has been faced with a number of constraints.

Notable among the constraints are inadequate access to agro-processing skills, use of obsolete and inappropriate technologies and lack of trained agribusiness workers. In most rural settings in Kenya lack of agro-processing skills among smallholder farmers, for example, has contributed to the low transition rate from trading in primary form of produce to value added or processed products [20]. These challenges raise the critical question of how training farmers in agro-processing skills would impact on growth of the smallholder agro-processing sub-sector in Kenya. For that reason, the past decade has witnessed a rapid movement away from provision of routine agricultural information to increased support for acquisition of agro-processing skills among smallholder farmers.

### III. OBJECTIVES OF THE STUDY

The objective of the study was to establish the impact of manufacturing skills training on growth of smallholder agro-processing industry in Bureti Sub-County, Kericho County, Kenya.

### IV. SIGNIFICANCE OF THE STUDY

The findings of this study have both theoretical and practical benefits to the future of agro-processing industry in Kenya. The study contributes to the advancement of knowledge about smallholder agro-processing industry in

general and the impact of agro-manufacturing skills training in particular. The study results could be useful in formulating future agro-processing development strategies for smallholder farmers in Kenya's agro-industry. The study results provide hints on the aspects which should be emphasized while allocating finances to the small-scale agro-processing businesses and development projects. The findings could influence farmers or producers, entrepreneurs, government and non-government organizations, who may want to intervene in the smallholder agro-processing and marketing chain. The study findings will, in particular, provide an indication to the Government of Kenya on whether implementation of the agro-industrialization policies articulated in The Kenya's Vision 2030 is yielding the expected impacts.

### V. CONCEPTUAL FRAMEWORK

The impact of agro-manufacturing skills on growth of agro-processing industry is anchored on the conceptual framework given in Figure 1.

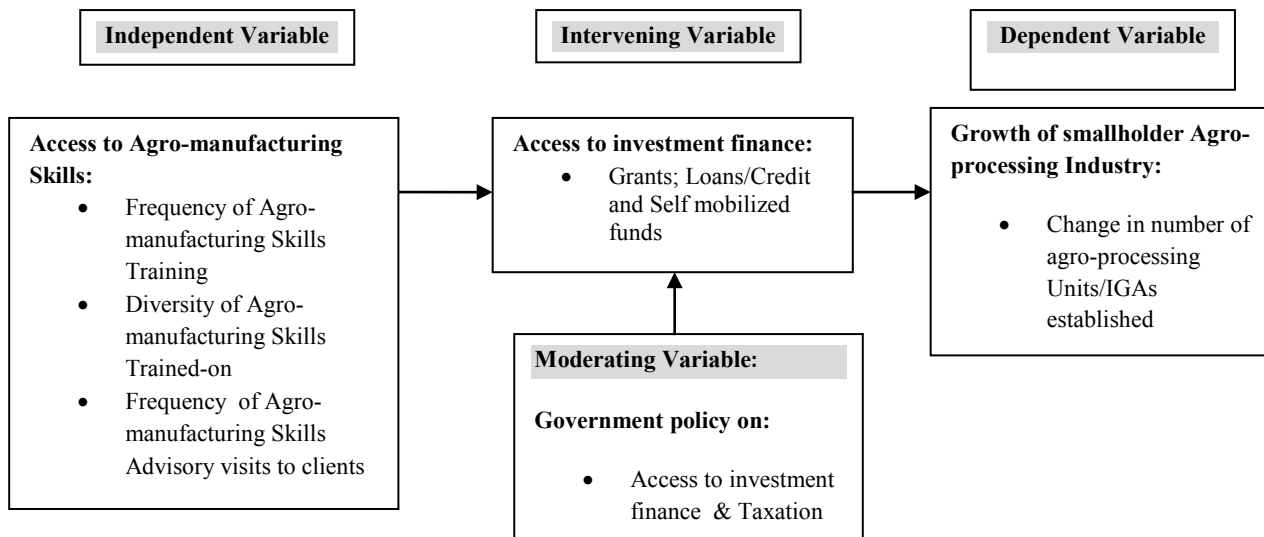

Fig. 1: The conceptual framework diagram

VII. FINDINGS AND DISCUSSIONS

It is postulated that the level of growth of smallholder agro-processing industry is affected by the degree of access to agro-manufacturing skills. Access to these skills is dictated by the frequency of manufacturing skills training, frequency of manufacturing skills advisory visits to farms or businesses; and types or diversity of manufacturing skills passed to the clients.

The variables in the study were; access to agro-manufacturing skills, which is the independent variable and level of growth of smallholder agro-processing industry (dependent variable). The relationship between the independent and dependent variables was regulated by access to investment finance (intervening variable). When finances are accessible to smallholder entrepreneurs it is assumed they use the funds to acquire manufacturing skills required in setting up and operating agro-processing units.

The study examined access to agro-manufacturing skills in the context of frequency of manufacturing skills training, frequency of manufacturing skills advisory visits to clients and the types of manufacturing skills trained-on as important factors in developing technological capability. The impact of manufacturing skills training on growth of the Small-holder agro-processing industry was measured in terms of increase in number of agro-processing units or businesses established.

VI. RESEARCH METHODOLOGY

The study was carried out using cross-sectional descriptive survey design. The sample comprised of 196 individuals drawn from target population of 400 members. It consisted of 183 smallholder agro-processors drawn from farmer groups, 3 individually practicing agro-processors and 10 agro-processing technical advisors. The study used mixed sampling techniques involving area sampling, purposive sampling in specific aspects and stratified sampling enriched with simple random method without replacement. Stratified sampling was used to separate agro-processing stakeholders into individual processors, group processors and processing advisory experts. A mixture of both quantitative and qualitative empirical data was collected. Data collection instruments included questionnaires and interview schedules.

Variables used in the instruments were identified by conducting a trial interview with 4 small-scale agro-processing entrepreneurs and 2 agricultural experts. A rough draft of the interview schedule and questionnaire were prepared and evaluated by professional researchers. Validation of the instruments was done by evaluating every item of the questionnaire and interview guide to determine their relevance to the study objectives. Test re-test method was used to ensure the reliability of the instruments. The results from test were correlated using Karl Pearson's product moment correlation to get internal consistency. The data was processed using SPSS programme and analyzed both qualitatively and quantitatively. Statistical procedures included descriptive statistics and inferential analysis. Results were presented in frequency tables

*A Frequency of farmer and expert information exchange and number of IGAs set-up*

The impact of frequency of exchange of agro-processing information between experts and farmers was examined.

Frequency of interaction is important for exchange of information and consequent adoption of agro-processing practices. It can occur by either farmers making visits to experts or when they are visited by the experts. The results of cross-tabulation between the frequency of contacts between agricultural experts and agro-processing farmers, and the number of agro-processing IGAs established by smallholder farmers are presented in Table I.

**Table I: Impact of farmers' advisory services on the number of agro-processing units established**

Frequency of experts' visits to farmers (Number of visits)	Impacts on the number of agro-processing IGAs established (Number of farmers)			
	<i>Gone Up</i>	<i>Remained Same</i>	<i>Gone Down</i>	<i>Total</i>
1 – 2 times per month	33 (17.7%)	14 (7.5%)	5 (2.7%)	52
3 – 4 times per month	5 (2.7%)	0 (0.0%)	0 (0.0%)	5
1 – 2 times per 3 months	52 (27.9%)	19 (10.2%)	19 (10.2%)	91
3 – 4 times per 3 months	10 (5.4%)	28 (15.1%)	0 (0.0%)	38
<b>Total</b>	<b>101 (54.3%)</b>	<b>61 (32.8%)</b>	<b>24 (12.9%)</b>	<b>186</b>

Source: Own Computation from the Study Data – July, 2013

The results indicated that 91(48.9 percent) of the information exchanges occurred 1 – 2 times in 3 months, 52(27.9 percent) 1 - 2 times per month, 38(20.5 percent) 3 – 4 times in 3 months, and 5(2.7 percent) 3 – 4 times per month. The results further showed that a significant 101 (54.3 percent) respondents perceived that the number of agro-processing IGAs had increased while 61 (32.8 percent) and 24 (12.9 percent) indicated that number of IGAs remained same and gone down, respectively. Information exchanges that occurred 1- 2 times in 3 months registered the highest increase in the number of agro-processing IGAs with 52 (27.9 percent) followed by 1 – 2 times per month at 33 (17.7 percent).

Pearson Chi-square Test was conducted to establish whether there was a relationship between frequencies of experts' visits to farmers and the number of smallholder agro-processing IGAs set-up in the rural areas. The findings are shown in Table II.

**Table II: Pearson Chi-square test for the relationship between frequencies of Experts' visits to farmers and the number of agro-processing IGAs established**

	Value	p-value
Pearson chi-square	216.422	0.009
N of valid cases	186	

Source: Own computation from study data – July, 2013

The findings indicated that there is a significant relationship between the number of visits to farmers made by agricultural experts and the number of agro-processing IGAs set-up by smallholder farmers in the study area (chi-square  $p$  - value = 0.009,  $p < 0.05$ ). The chi-square ( $X^2$ ) value was significant at 0.05 confidence level, indicating that the frequency of visits to farmers by agricultural experts caused a statistically significant influence on the number of agro-processing IGAs established by smallholder farmers in Bureti Sub-County.

*B. Frequency of farmers' manufacturing skills training sessions and agro-processing IGAs established*

Technical training on agro-processing technologies is deemed an effective way of passing manufacturing skills to farmers. Manufacturing skills enable farmers to develop capacity to start and operate agro-processing businesses in the rural areas where they live. How often these skills are passed or refreshed is an important factor in capacity building. The numbers of agro-manufacturing training sessions held for agro-processing farmers are given in Table III.

**Table III: Average number of farmer agro-manufacturing training sessions held**

Average number of training sessions per year (Number)	Mean	Frequency	Percent (%)
1 – 4	2.5	130	70
5 – 8	6.5	56	30
<b>Total</b>		<b>186</b>	<b>100.0</b>

Source: Own computation from the study data – July, 2013

Results from Table III show that seventy (70.0) percent of agro-processors attended between 1 and 4 agro-processing training sessions per year. The remaining 30.0 percent of agro-processors attended between 5 and 8 training sessions in a year. Cross-tabulation between the agro-manufacturing training conducted and number of agro-processing IGAs established indicate that 47 (51.6%) of those who responded had received agro-manufacturing training. Forty four (48.4%) respondents had not received training. Of those who had received training 18 (38.3%) indicated an increase in the number of agro-processing IGAs while 27(57.4%) did not realize any change, and 2 (4.3%) perceived a decline in the number of IGAs (Table IV). The results also showed that none (0.0%) of the untrained respondents registered positive growth in the number of agro-processing IGAs. Majority or 30 (68.2%) of the untrained did not realize change in number of IGAs while 14 (31.8%) recorded decline.

**Table IV: Cross-tabulation between agro-manufacturing training conducted and number of IGAs established**

Agro-processing training conducted for Farmers	Impact on the number of agro-processing IGAs established (Number of farmers)			
	Gone Up	Remained Same	Gone Down	Total
NO	0 (0.0%)	30 (33.0%)	14 (15.4%)	44
YES	18 (19.8%)	27 (29.7%)	2 (2.2%)	47
<b>Total</b>	<b>18 (19.8%)</b>	<b>57 (62.6%)</b>	<b>16 (17.6%)</b>	<b>91</b>

N=186 (Valid = 91; Missing = 95)

Pearson Chi-square Test was conducted to establish whether there was a relationship between agro-processing training conducted and the number of smallholder agro-processing IGAs set-up in the rural areas. The findings are shown in Table V.

**Table V: Pearson Chi-square test for the relationship between agro-manufacturing training held and the number of agro-processing IGAs established**

	Value	p-value
Pearson chi-square	22.54	0.003
N of valid cases	91	

Source: Own computation from study data – July, 2013.

The findings indicate that there was a significant relationship between agro-processing training conducted and the number of agro-processing IGAs set-up by smallholder farmers in the study area (chi-square  $p$  - value = 0.003:  $p < 0.05$ ). The chi-square ( $X^2$ ) value 22.54 was significant at 0.05 confidence level, indicating that agro-processing training of farmers caused a statistically significant influence on the number of agro-processing IGAs established by smallholder farmers in Bureti Sub-County.

*C. Types of farmers' agro-manufacturing technical skills training conducted and number of IGAs established*

Types of agro-manufacturing training modules conducted determine the scope of processing operations that can be performed and competency level of agro-processing entrepreneurs in executing the various manufacturing activities. Farmers or agro-processors trained on a wide range of manufacturing skills are expected to acquire capacity to perform or guide most of the processing operations in their businesses effectively. The types of agro-manufacturing training provided to the study respondents are summarized in Table VI.



**Table VI: Cross-tabulation between types of agro-manufacturing technical skills trained-on and number of agro-processing IGAs established**

Agro-manufacturing Skills Trained-on	Access Level (%)	Impact on the number of Agro-processing IGAs Established (No of farmers)			Chi-square p-value
		Gone Up	Remained Same	Gone Down	
Agro-processing Skills	98.8	44(23.4%)	110(59.8%)	30(16.3%)	<b>0.006</b>
Product Quality	44.4	31(37.3%)	52(62.7%)	0(0.0%)	<b>0.002</b>
Preservation Techniques	45.1	42(50.0%)	30(35.7%)	12(14.3%)	<b>0.002</b>
Equipment Selection	25.6	26(54.2)	22(45.8%)	0(0.0%)	<b>0.002</b>
Product Development	82.9	29(18.8%)	121(78.6%)	4(2.6%)	<b>0.047</b>
Safety Measures	30.1	16(28.6%)	30(53.6%)	11(19.6%)	<b>0.432</b>

Source: Own Computation from the Study Data – July, 2013

Results from the study indicate that smallholder agro-processing respondents were provided with agro-manufacturing training on six (6) main skill areas. These skill areas included processing techniques, product quality, product preservation, equipment selection, business plan development, marketing planning, product development and production scheduling. Results show that access to agro-processing skills was generally good with most IGAs rating their access levels at more than 70.0 percent. Below average levels of access were found in skill areas like preservation (45.1 percent), quality control (44.4 percent) and equipment selection and maintenance (25.6 percent). Inadequate access of these skills was confirmed by DAO Bureti since the “*district lacks experts in these subject areas*”. This position is further confirmed by the findings from this study that showed that relevant specializations such as Agricultural Engineering which is required for guiding in equipment selection and maintenance and quality control, and Home Economics which is needed for preservation techniques are either lacking or under represented (Table 10). Findings further indicated that different types of agro-manufacturing skills had varied positive impacts on the number of agro-processing IGAs established. The highest positive change was registered in agro-processing skills 44 (23.7%) followed by preservation techniques 42 (22.6%), product quality skills 31 (16.7%), product development 29 (15.6%), equipment selection 26 (14.0%), and safety measures 16 (8.6%).

*D. Relevance of farmers’ agro-manufacturing technical training conducted*

Relevance of the agro-processing training offered to farmers was examined as a measure of usability of the knowledge and skills gained in the agro-processing IGAs. Findings of the relevance of the training are given in Table VII:

**Table VII: Rating of Farmers’ Agro-manufacturing Technical Training Relevance**

Rating of Training Relevance (%)	Frequency	Percent (%)
80 - 100	38	20.4
60 - 79	130	70.0
40 - 59	9	4.8
30 - 39	9	4.8
<b>Total</b>	<b>186</b>	<b>100.0</b>

Source: Own Computation from the Study Data – July, 2013

The study found that 38 (20.0 percent) agro-processing respondents indicated 80.0 to 100.0 percent relevance of the training offered. Total of 130 (70.0 percent) respondents indicated 60.0 to 79.0 percent relevance. Other agro-processors indicated 40.0 to 59.0 percent relevance and 30.0 to 39.0 percent relevance each reported by 4.8 percent of the agro-processors. Findings show that a significant 90.4 percent of the study respondents gave a relevance rating ranging from 60.0 percent to 100.0 percent. Only 4.8 percent of the

respondents rated the training relevance below 40.0 percent. Comparison of the Pearson Chi-square values generated from tests for the relationships between the various relevant agro-processing training modules conducted and the number of agro-processing IGAs established was done to confirm if the farmers' rating of training relevance was backed by a strong relationship with the number of agro-processing IGAs. The findings are presented in Table VIII.

**Table VIII: Comparison of Pearson Chi-square tests for the relationship between processing training modules rated relevant and the number of agro-processing IGAs established**

Relevant agro-manufacturing training modules conducted	Pearson Chi - square values	Chi - square
	<i>Value</i>	<i>p-value</i>
Agro-processing Skills	182.564	0.006
Product Quality Skills	28.083	0.002
Equipment Selection Techniques	12.938	0.002
Preservation Techniques	20.453	0.002
Safety Skills	3.677	0.432

Source: Own Computation from Study Data – July, 2013

The findings indicated that there was a significant relationship between most of the relevant agro-processing training conducted and the number of agro-processing IGAs set-up by smallholder farmers in the study area (processing skills: chi-square  $p$  - value = 0.006 :  $p < 0.05$ ; quality skills:  $p$  - value = 0.002 :  $p < 0.05$ ; equipment selection skills:  $p$  - value = 0.002 :  $p < 0.05$ ; preservation techniques:  $p$  - value = 0.002 :  $p < 0.05$ ; safety skills:  $p$  - value = 0.432 :  $p > 0.05$ ). All the chi-square ( $X^2$ ) values, except for safety skills, were significant at 0.05 confidence level, indicating that all except one training rated relevant by farmers caused a statistically significant influence on the number of agro-processing IGAs established by smallholder farmers.

The content of agricultural extension messages delivered to farmers during visits by experts was investigated as a measure of relevance. Messages with high agro-processing related content were considered more relevant than those with lower content.

Table IX presents findings on the content of information exchanged between experts and farmers during the agricultural extension visits.

**Table IX: Proportion of agricultural extension messages with agro-processing content**

Percent (%) processing content in extension messages	Agro-Frequency	Percent (%)
--	----------------	-------------

Less than 10	37	20.0
21 - 40	112	60.0
51 – 70	37	20.0
<b>Total</b>	<b>186</b>	<b>100.0</b>

Source: Own Computation from the Study Data – July, 2013

The results indicate that the highest number (51-70 percent) of extension messages with agro-processing content was reported to have been passed by 20.0 percent of the agricultural experts. Notably about 80.0 percent of experts advised farmers on less than 40.0 percent issues with agro-processing content. This may be taken to mean that, on average, agro-processing content in the agricultural information passed to farmers during routine extension contacts with farmers lied between 10.0 and 40.0 percent.

## VIII. CONCLUSIONS

Establishing the impact of manufacturing skills training on growth of smallholder agro-processing industry concluded that the frequency of expert-farmer exchanges of agricultural information was generally adequate although agro-processing content in the agricultural extension packages were low at less than 40.0 percent. Similarly, the frequency of farmers' agro-manufacturing training sessions conducted by agricultural experts was adequate. The diversity of agro-manufacturing skills trained-on was broad enough. Access to these skills was generally good but not uniform in all agro-processing IGAs because the Sub-county lacked relevant experts in some subject areas. Agro-manufacturing skills trainings provided by the Agricultural experts were relevant to the needs of the smallholder agro-processors. The level of agro-manufacturing skills in agro-processing IGAs was sufficient for some processing activities but remained a challenge to most smallholder agro-processors in other areas. Agro-manufacturing training skills offered to farmers had positive net impact on the number of agro-processing IGAs as some adopted and implemented some aspects of the skills acquired from the training sessions and this led to establishment of new units.

## IX. RECOMMENDATIONS

In view of the findings of this study, the following recommendations are made for consideration in the future intervention strategies aimed at enhancing growth and development of smallholder agro-processing industry among the rural farmers in the study area:

1. The government and other agricultural service providers should embrace personnel deployment policy that is based on matching staff specializations with the critical needs of the farmers or clients so as to ensure value in service

provision and thus attainment of broader national objectives such as Kenya Vision 2030.

2. The level of agro-processing skills content in the agricultural extension packages passed to farmers should be increased to reflect the current national policy focus on value addition/agro-processing as a way of commercializing agriculture.
3. The Ministry of Agriculture should increase the number of agricultural extension experts in-order to improve expert-to-farmer ratio for better access of agro-processing technologies by farmers.
4. The Ministry of Agriculture should embrace synergy with other agro-processing service providers such as KIRDI, KEBS, Ministry of Industrialization, JKUAT, GiZ etc in-order to comprehensively mentor and grow the small-scale agro-processing IGAs to a level where they can exploit all agro-manufacturing skill opportunities.

#### ACKNOWLEDGEMENTS

The authors wish to thank the Department of Extra Mural Studies, University of Nairobi for guiding this study; agro-processing groups and individuals in Bureti Sub County who provided information that formed the basis of the results presented in the study.

#### REFERENCES

- [1] Odoyo-Bittar, J. and Nyonje, R. O. (2014). Impact of Manufacturing Equipment on Growth of Smallholder Agro-processing Industry in Bureti District, Kericho County, Kenya. Department of Extra Mural Studies, University of Nairobi, A paper presented at the 2014SRI Conference, AICAD-JKUAT, Juja-Kenya.
- [2] World Bank (2008). Global Economic Prospects: Technology Diffusion in the Developing World.
- [3] Tamidi, L. T. (2005). The Importance of MSES in Economic Development of Developing APEC Countries: Paper Presented at the APEC Study Centre Consortium Conference 2005, Jeju, Korea, 22-25 May 2005. Director, ASC University of Indonesia - Micro, Small-Scale And Medium Enterprises (MEMES).
- [4] NEPAD, (2009). CAADP, How Are Countries Measuring Up to the Maputo Declaration, Johannesburg: NEPAD, 2009.
- [5] Shehrawat, P. S. (2006). Agro Processing Industries - A Challenging Entrepreneurship for Rural Development, Dept. of Extension Education, CCS Haryana Agricultural University, Hisar-125004. The International Indigenous Journal of Entrepreneurship, Advancement, Strategy and Education.
- [6] Nazare, R.M. (2005). The Status of Agricultural Mechanisation Input Supply Chains in Zimbabwe and Strategies for Improving Input Supply. Assessment Mission Report prepared for the Department of Agricultural Engineering and Technical Services and Food and Agricultural Organisation of the United Nations.
- [7] De Janvry, A., Graff, G., Sadoulet, E. and Zilberman, D. (2001). Technological Change in Agriculture and Poverty Reduction - Concept Paper for the WDR on Poverty and Development 2000/01, University of California at Berkeley.
- [8] Saikia, H. (2012). Measuring Financial Performance of Small Scale Industries: Some Evidences from India. Journal of Applied Economics and Business Research JAEBR, 2(1): 46-54 (2012) Copyright © 2012 JAEBR ISSN 1927-033X . Department of Economics, Debraj Roy College, Assam, India.
- [9] Braggs, D., Galvin, W., Lambrechts, K., MacRae, M., Parrott, N., Peacock, C., Powell, S., Rafanomezana, J., Taylor, D., Warburton, H., Willoughby, R. and Wills, O. (2010) – Africa’s Smallholder Farmers: Approaches that work for viable livelihoods. A report by the African Smallholder Farmers Group (ASFG)
- [10] Mhazo, N., Mvumi, B. M., Nazare, R. M. and Nyakudya, E. (2003). The Status of the Agro Processing Industry in Zimbabwe with Particular Reference to Small and Medium Enterprises; University of Zimbabwe.
- [11] DAO Bureti, (2010). Annual Report: District Agricultural Office – Ministry of Agriculture, Bureti District: Kenya.
- [12] Kansal, R. and Sonia, S. (2009). Globalization and its Impact on Small Scale Industries in India: Growth of Small Scale Industries in India: Pre and Post Globalization Vol. 1, No. 2 (June, 2009) pp. 135-146 ISSN 0974-9977- Department of Commerce, Punjabi University, Patiala (Punjab).
- [13] Kindness, K., and Gordon, A. (2001). Agricultural Marketing in Developing Countries: The Role of NGOs and CBOs. Natural Resources Institute, February 2001
- [14] Agrifica (2012). Think Agribusiness Africa, 2012: The role of China in Africa’s agribusiness.
- [15] Republic of Kenya (2009). Agricultural Sector Development Strategy: 2009 - 2020; Agricultural Sector Ministries – Sector Working Group, GoK.
- [16] Hazell, P. et al (2006): Is There a Future for Small Farms? Synthesis Paper, London: Overseas Development Institute, November 2006.
- [17] Gitonga K .J, et al (2010). Enhancing Small Scale Farmers’ Income in Mango Production through Agro-Processing and Improved Access to Markets; Kari-Thika, Box 220 Thika
- [18] Practical Action (Jan 2011) - Sustainable livelihoods through Agro-processing: Practical Action, The Schumacher Centre, Bourton on Dunsmore, Rugby, CV23 9QZ, UK. +44(0)1926634400 practicalaction@practicalaction.org.uk.
- [19] MoA (2009): Strategic Plan (2008 – 2012): Ministry of Agriculture, Kenya.
- [20] Stubbs I., Mwangangi B., Muiruri P., and Mwangangi S. (2010): Strengthening the Viability of Common Interest Groups (CIGs) for Agribusiness Development, NALEP, Ministry of Agriculture, Kenya.

# The use of Separability Number and SARA Fractionation in Studying Asphaltenes Stability in Residual Fuel Oil.

John Otieno Odhiambo<sup>1a</sup>, Wei HaiJun<sup>2b</sup>, Jotham Muthoka Munyalo<sup>3a</sup>, Jia Fengguang<sup>4b</sup>

**Abstract**— Asphaltenes in marine fuel oils pose major challenges to the oil and shipping industries since they are responsible for major problems faced by fuel handling equipment. Unstable fuels contain solid agglomerates of asphaltenes that may block nozzles of fuel injectors, cause filter clogging and alter combustion characteristics of the fuels. This paper proposes a method of asphaltenes stability analysis in residual fuel oil using separability number as investigated by Near Infrared Optical Scanning Machine (NIR-OSM) in conjunction with Saturates, Aromatics, Resins and Asphaltenes (SARA) fractionation method.

SARA fractionation was done using SYDA-0618A Asphaltene Chemical Composition Tester. The study combined the use of separability number and stability indices in predicting the stability of six IFO 180 fuel oil samples.

The method of stability analysis involved mixing of six IFO 180 fuel oil samples, from different users, with toluene then the oil/toluene mixture was mixed with n-heptane and phase separation allowed to proceed. The rate of phase separation was then measured as variation in the transmittance of NIR light across a glass vial containing the test mixture. The separability number was then used as a measure of stability reserve in the fuel oil samples. The SARA fractions were used to calculate the Colloidal Instability Indices, the Asphaltene-Resin ratio methods was then used to validate the results found by the separability number analysis method.

The Colloidal Instability Index was found to be more accurate than the Asphaltene-Resin ratio. The stability results by the CII and separability number results gave similar predictions of stability reserve in the fuel oil samples. There is a close relationship between the separability number and CII. Asphaltene-Resin ratio is less accurate in stability reserve prediction in residual fuel oils than CII and separability number.

**Keywords**— Asphaltenes Stability, Stability Reserve, Separability Number, SARA Fractionation, Colloidal Instability Index.

## I. INTRODUCTION

**A**SPHALTENES are a constituent of crude oils and residual fuel oils colloiddally dispersed as micelles in the fluid medium<sup>[1]</sup>. Crude petroleum is a mixture of many different hydrocarbon compounds with a wide range of boiling points<sup>[2]</sup>. The compounds are usually separated by fractional distillation. It is through the fractionation that the

molecular boundaries of petroleum are defined<sup>[2]</sup>. However, even after the light fractions have been separated, the residual fractions will still contain asphaltenes, Sulfur and traces of Nickel, Vanadium and Iron depending on the crude source<sup>[2]</sup>.

The viscous and flocculating nature of asphaltenes has had and continues to impact adversely in crude oil production, transportation and processing. Its presence in fuel oil also poses major challenge to bunker companies and ships. Permeability reduction, wettability alteration in the formation, pipeline plugging, and pumps failure at the surface, catalyst poisoning and heat exchangers fouling at the refinery, corrosion of operational compartments and plugging of the wells are some of the major challenges associated with asphaltene deposition<sup>[3,4]</sup>.

Asphaltenes have a high affinity towards aggregation and as a result, precipitate and deposit in production and processing equipment<sup>[5]</sup>. Flocculation and precipitation are due to the aggregation of the “macro-molecules” constituted of aggregated asphaltene monomers. The aggregation of asphaltene macro-molecules consisting of asphaltene monomers is the main cause of flocculation and precipitation.

When these asphaltenes precipitate and deposit on processing equipment, remediation methods are very expensive and even lead to total abandonment of a well or it can greatly impair the operation of an engine. Therefore, the ability to predict stability of asphaltenes in fuel oil and crude oil propensity to precipitate asphaltenes is of utmost importance.

Given credible data on the stability of asphaltenes, crude oil producers and processors are able to assess any asphaltene deposition threat and to incorporate preventive measures in the design stage to reduce or eliminate the impact of asphaltene deposition.

Most of the methods developed to determine the stability of asphaltenes in oils are proprietary and not readily available to the public. Some of the older but more popular methods for determining the stability of asphaltenes are the Asphaltene-Resin ratio and the Oliensis Spot Test<sup>[5]</sup>. Newer tests include solvent titration with solids detection and the Colloidal Instability Index<sup>[6]</sup>.

The solvent titration method also called the Asphaltene

---

Otieno Odhiambo John, Department of Marine Engineering and maritime Operations, JKUAT : +2540723935272, jodhiambo@jkuat.ac.ke.

Precipitation Detection Test (APDT) <sup>[7]</sup> measures the onset of asphaltene flocculation point using a solid detection system with a near infrared (NIR) laser. The onset of asphaltene flocculation point is expressed as the APDT number defined as the ratio of volume of solvent titrated to mass of oil used. This number provides a relative measure of how stable the asphaltenes in the oil are. Using a database of numerous measurements, the stability cutoff point is set at 1.5 above which oil is considered to have stable asphaltenes.

Stability indices analysis for stability is done using the SARA fractionation results. The saturate fraction of the SARA fractions consists of non-polar materials that include linear, branched, and cyclic saturated hydrocarbons. The proportions of the SARA fractions in crude oil or fuel oil are related to the stability of asphaltenes in the candidate oils. The use of the ratio of resins to asphaltenes as an indicator of asphaltene stability is based on the hypothesis that resins confer asphaltene stability by peptizing (or coating) asphaltenes <sup>[8]</sup>.

The stability of a colloid dispersion is defined as its resistance to flocculation. The extent of the resistance can be used as a measure of the dispersion stability <sup>[9]</sup>. The destabilization (i.e., flocculation) of colloidal asphaltenes in depends mainly on breaking up the balances of attraction forces between the absorbed resin molecules and asphaltenes particles <sup>[9]</sup>. The stability indices are crucial in

the stability analysis of both crude oil and residual fuel oil. The methods include the asphaltene-resin ratio and the colloidal instability index (CII). The asphaltene-resin ratio is the ratio of asphaltenes to resins calculated using weight percentages obtained from (SARA) analysis.

## II. EXPERIMENTAL SECTION

### A. Apparatus

1. The PC-based Computer
2. The NIR-OSM

The NIR-OSM is the main experimental apparatus for the separability number analysis. It consists of a reading head that has a pulsed near infrared light source with a wavelength of 850nm.

3. SYDA-0618A Asphaltene Chemical Composition Tester

The instrument is based on the industry standard of the People's Republic of China JTG E20-2011 (Highway asphalt and asphalt testing procedures in "T 0618-1993" chemistry of asphalt tester (four-component method).

The instrument consists of asphaltene extractor (including condenser and a 100ml spherical surface extraction assembly) and glass adsorption column, its structure and technical parameters are in full compliance with T0618-1993 standard.

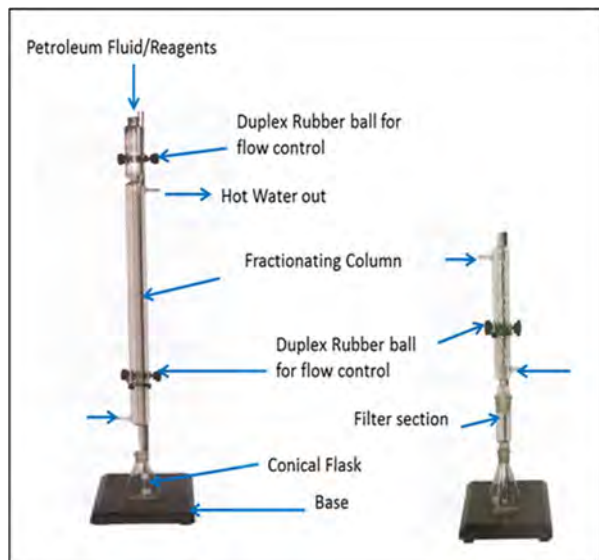

Fig. 1: The test assembly for the SARA fractionation experiment

#### 4. Other Apparatus

- i. Cylindrical Clear Glass Vial with Screw Cap, 15ml of 16mm outside diameter, 12 mm inner diameter, and 140 mm high used as a sample container.
- ii. Graduated Pipette, 5ml and 10ml.
- iii. 25ml Graduated Cylinder.
- iv. Clear glass bottle with cap, 250ml and 50ml.
- v. Magnetic TFE-fluorocarbon-coated.
- vi. Magnetic stirrer
- vii. Balance, precision of 0.01g
- viii. Filter paper: medium speed of 110 mm to 125 mm.
- ix. Dryer
- x. Vacuum oven, blast drying oven.
- xi. Electric hot plate (heating units).
- xii. Others: porcelain evaporating dish (300mL), pipette, distilled water fine mouth bottle, glass funnel, funnel holder, two linked rubber balls
- xiii. High temperature furnace: 0 °C ~ 1000 °C with automatic temperature controller.
- xiv. Constant temperature water tank: with accuracy of +/- 1 °C.
- xv. Grinding mouth conical flask: 250mL.
- xvi. Measuring cylinder: 250mL, 50mL, and 100mL.

#### B. Reagents and Materials

- i. N-Heptane (C<sub>7</sub>H<sub>16</sub>)
- ii. Toluene (C<sub>6</sub>H<sub>5</sub>CH<sub>3</sub>)
- iii. Used IFO 180 fuels from different users originally supplied by China Marine Bunker Supply Company Ltd The samples were numbered as follows;

- OIL SAMPLE 1 – Ningbo Sample, OIL SAMPLE 2 - Shanghai ZR Sample Shenran,  
OIL SAMPLE 3 - Shanghai ZR Sample Hailian 62,  
OIL SAMPLE 4 - Shanghai ZRC sample 1  
OIL SAMPLE 5 – Shanghai ZR sample Ludingtan  
OIL SAMPLE 6 – Shanghai ZR sample Tongyin

- iv. Aluminum Oxide: for chromatography, neutral, with particle size of 0.15mm-0.075mm (100-200mesh) specific surface area more than 150 m<sup>2</sup> / g and 250 / g pour volume.
- v. Petroleum ether: 60 °C ~ 90 °C, analytically pure
- vi. Ethanol and acetone
- vii. Silica gel: pore size 0.42mm ~ 0.15mm (40 - 100 mesh size).
- viii. N/B: The reagents used were of technical grade with 95% purity

#### C. Procedure for separability number analysis

An appropriate amount of IFO 180 was weighed on a balance (usually close to 5g) and diluted with toluene, in a weight ratio of 1:9 then put in a bottle with cap and then shaken well. The oil-toluene solution was then stirred by a magnetic stirrer for about 1h 30minutes. The Near Infrared Optical Scanning Machine (NIR-OSM) was then turned on and set for automatic scanning every 12s for 15 minutes. Using a pipette 2ml of the oil/toluene mixture prepared above was added to the heptane and the mixture shaken briskly for about 6s. Using a pipette, 7ml of the oil-toluene-heptane mixture was immediately transferred into the cylindrical clear glass vial and the cap screwed tightly. The test glass vial was then secured between the NIR probe and the NIR detector. The sample was then scanned as per the procedure and the transmittance recorded for analysis. After the measurement was complete, the glass vial was removed from the NIR-OSM and cleaned with toluene in a fume hood.

#### D. Test procedure for SARA fractionation

The 250ml conical flask was weighed and re-weighed to a constant weight accuracy of +/- 0.01g. 60mL of n-heptane per gram of sample was injected in the conical flask. The flask was then connected to the condenser, using a hot plate or heating units and heated for between 0.5h-1hr, and cooled slightly (after removing the stopper) then allowed to stand in the dark for about 1.5 - 2hrs. The contents in (n-heptane solution) conical flask1 were slowly filtered into conical flask 2 using a filter paper. The 30ml conical flask was washed with hot n-heptane (60 ~ 70 °C) several times and filtering until the entire asphaltene residue were cleared. The filter paper and residue were removed after folding the filter paper into the extraction apparatus fitted with conical flask2 which had the filtrate. The system was then connected to the condenser with electric heating capability and extracted after 1hr. The asphaltenes on the filter paper were flushed and rinsed using

n-heptane until the dropping liquid was colorless. After cooling off conical flask2, the filter paper was extracted making sure it remained intact. 60ml of toluene was added into the conical flask1 and connected to the asphaltene extraction apparatus, allowed to filtrate for 1hr until the filtrate is colorless and the residue on the filter paper and the residual carbon is inorganic. After cooling conical flask (1) to room temperature, the toluene solution was recycled and placed in a vacuum at temperature of 105 °C +/- 5 °C, 93kPa +/-1kPa (700mmHg +/-10mmHg) for 1hr making sure the toluene is vaporized completely, then put in the dryer, cooled to room temperature and the mass measured to an accuracy of up to 0.1 mg. This is the mass of asphaltene in the oil sample.

The content of the conical flask2 was recovered (most of which is toluene) and then concentrated to about 10ml. The constant temperature water tank was started and the water temperature controlled to 50 °C +/- 1 °C. The adsorption column below the glass was washed and then dried using a small amount of cotton wool plug and a funnel was then used to load from the top, 40-50g (accuracy 0.1g) of activated alumina tapping gently with a glass rod to attain uniform packing. 30ml of n-heptane was added into the adsorption column with activated alumina and let to filter into flask (2) after adding the sample containing asphaltene. It was then washed 2-3 times with 10ml of n-heptane (The amount of n-heptane after the rinsing is saturated to 80mL of n-heptane) into the glass adsorption column. All the sample solution was put into the alumina column adding a small amount of alumina (0.3g) and covering the surface with a cotton wool. The glass measuring cylinder was set at the bottom of the absorption column and the filtrate collected until pure n-heptane began to flow.

Following the same steps, more alumina was put in the column and rinsed using n-heptane. The amount of solvent per gram of alumina was then calculated as follows;

Table 1: Amount of solvent per gram of alumina

Washing Solvent		Amount (mL / g, alumina)
1 <sup>st</sup>	N-heptane	80 (Should be deducted from the total amount of n-heptane that has been used for flushing)
2 <sup>nd</sup>	Toluene	80

Note: The first flushing for the aromatic recovery can be achieved by the petroleum ether instead of n-heptane but after saturation point is reached; n-heptane must be used.

The initial flow of pure heptane was 20 ml, and this volume was made available to repeated use as a part of the total 80 ml n-heptane. After numbering and weighing of the constant weight conical flasks used to receive the solution from the outlet of the absorption column, care was taken to make sure

that the volume of the recycled solution was not more than two-thirds of the flask capacity.

The flow rate was adjusted constantly by applying pressure of the duplex rubber ball. The flow was controlled (not so fast and also not too slow) to ensure sufficient adsorption. When the filtrate was no longer yellow, the flow rate was made slightly faster. The flow rate of the whole process was controlled to within 2-4ml/min.

The color of the filtrate changes every time a different kind of solution (toluene or n-heptane) is injected into the alumina column. The change in colors marks the boundary for the different fractions of the sample fuel. When different boundary colors of solvent reach the bottom of the chromatographic column, the constant weight receiving conical flask is replaced.

When n-heptane was used as the first washing solvent, the filtrate collected was the colorless saturates. When toluene was used as the second washing solvent, the filtrate collected was the aromatics and the color is yellow to dark brown.

After the basic recovery of solvents, the conical flasks containing the different components were placed in the vacuum drying oven and dried for 1 hour in vacuum with controlled temperature. The flasks were then taken out and cooled to the room temperature in a dryer and their masses were weighed to an accuracy of 0.1mg. The weights for saturates and aromatics were then recorded and the percentage composition. The percentage composition of resins was calculated using subtraction equation. A table was generated for the percentage compositions.

### III. RESULTS AND DISCUSSION

#### A. Separability Number

The results of the experiment on the six fuel oil samples as presented on a previous publication by J Otieno Odhiambo was used.

Table 2: Average % transmittance for the six oil samples and the separability numbers (Otieno Odhiambo John, 2013)

	Samples					
	1	2	3	4	5	6
Average % Transmittance	5.90	4.97	6.64	6.06	5.18	5.66
	5.93	5.11	7.07	6.02	5.23	5.59
	6.03	5.38	8.02	6.01	5.38	5.54
	6.21	5.69	9.86	6.00	5.55	5.51
	6.55	6.20	12.43	6.00	5.79	5.49
	7.02	7.04	14.90	6.01	6.10	5.49
	7.91	8.33	16.93	6.01	6.51	5.48
	9.57	10.02	18.29	6.04	7.01	5.48
	11.93	11.89	19.60	6.02	7.56	5.50
	14.79	13.74	20.45	6.04	8.05	5.49
	17.51	15.26	21.22	6.11	8.56	5.50
	19.79	16.47	21.95	6.16	9.01	5.52
	21.55	17.42	22.57	6.24	9.40	5.58
	22.98	18.43	23.21	6.36	9.82	5.67
	24.06	19.25	23.79	6.49	10.15	5.79
25.06	20.02	24.26	6.73	10.42	5.98	
Separability No.	<b>7.39</b>	<b>5.62</b>	<b>6.29</b>	<b>0.21</b>	<b>1.88</b>	<b>0.134</b>

The API gravity and SARA fraction results from the experiment were tabulated as in table 3

The Colloidal Instability Index (CII) and the Asphaltene/Resin Ratios were then calculated from the results of SARA fractions as follows;

$$CII = \frac{(Saturates + Asphaltenes)}{(Resins + Aromatics)}$$

and

$$A/R = \frac{Asphaltenes}{Resins}$$

Table 3: The API Gravity, SARA Fraction and Stability Indices for the six fuel oil Samples

	API GRAVITY	SATURATES (Wt. %)	AROMATICS (wt. %)	RESINS (Wt. %)	ASPHALTENES (Wt. %)	A/R	CII
OIL 1	13.23	46.27	29.74	14.236	11.674	0.820	1.272
OIL 2	12.67	47.50	32.69	12.236	7.634	0.619	1.225
OIL 3	13.98	42.85	38.17	14.567	4.176	<b>0.287</b>	<b>0.892</b>
OIL 4	14.27	41.19	35.93	17.351	5.226	<b>0.301</b>	<b>0.871</b>
OIL 5	14.38	32.48	48.72	14.486	4.276	<b>0.295</b>	<b>0.581</b>
OIL 6	14.65	37.04	43.91	16.849	3.039	<b>0.180</b>	<b>0.671</b>

### B. Colloidal instability index and asphaltene/resin ratios

For a given fuel oil sample, the lower the ratio; the more stable is the oil. The 0.35 value of A/R is considered to be the cut-off point below which oil samples are considered stable. The ratio is popular and widely used since the asphaltenes and resins form the non-volatile parts of fuel oil and hence can be measured accurately. Moreover, the ratio makes sense intuitively since the resins are the fractions that peptize asphaltenes and keep them in solution. However, the method has been known to incorrectly predict the stability of asphaltenes in some fuel oils.

From the experiment, A/R predicted oil samples 1 and sample 2 as unstable with A/R values greater than 0.35. The remaining four fuel oil samples were predicted by this method as stable.

The colloidal instability index measures relative stability in a given fuel oil sample. The lower the value; the more stable the asphaltenes in the oil. Empirical evidence over the years has shown that oils, has shown that values of 0.9 and more indicate an oil with unstable asphaltenes while values below 0.7 indicate an oil with stable asphaltenes. Fuel oils with CII values between 0.7 and 0.9 have uncertain stability conditions and more tests are recommended for accurate prediction. In this study, oil sample 1 and oil sample 2 are unstable. Oil sample 5 and oil sample 6 are stable while oil sample 4 and oil sample 3 are in the uncertain region. As can be seen, A/R predicted the stability of sample 3 and sample 4 incorrectly. It is only after applying the CII that we are able to know that these oil samples are neither stable nor unstable.

When these stability results are compared with the stability generated by the Separability number, it is found that both methods predict the stability of oil samples 1, 2, 4 and 5 correctly. The stability of oil sample 3 and oil sample 4 are in the uncertain region. The separability number analysis categorizes them as "moderately stable". Therefore, the results of stability as found by separability number are more superior, accurate and highly sensitive as is confirmed by the stability indices analysis.

### C. Relationship between Stability Indices, API Gravity and Asphaltene Content with Separability Number

The separability number results were used here to check for any relationship with the SARA fractions. The following are results from the comparisons;

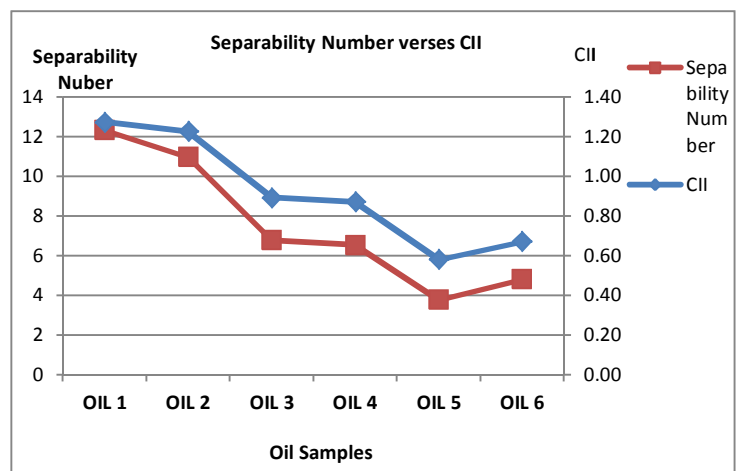

Fig. 2: Comparison between Separability Number and CII

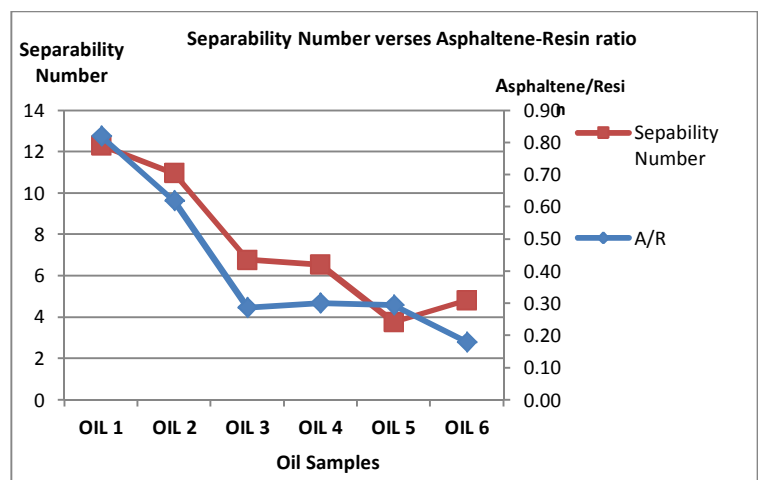

Fig. 3: Comparison between Separability Number and Asphaltene-Resin ratio



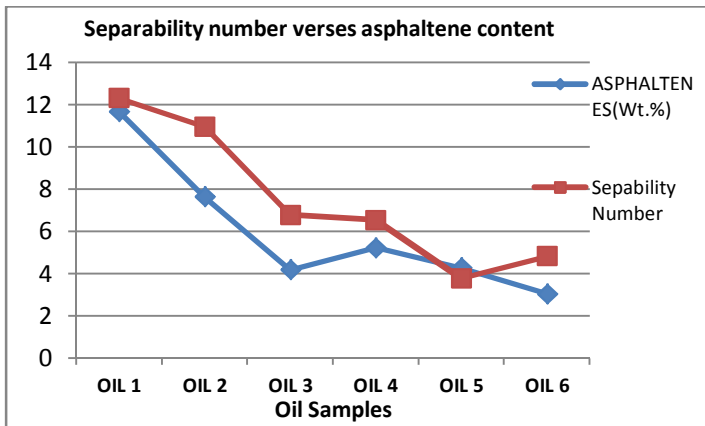

Fig. 4: Relationship between separability number and asphaltene content

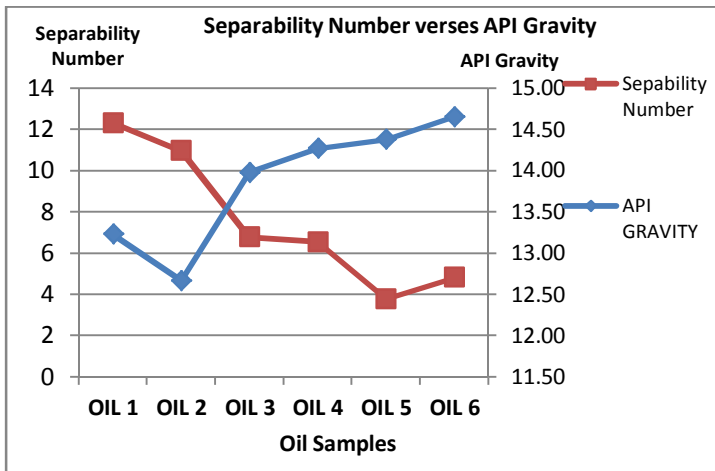

Fig. 5: Relationship between separability number and API gravity.

From the analysis, it can be seen that separability number is directly related to CII and Asphaltenes-Resin ratio. Since both the three methods are used in testing stability and they are expected concur. The concurrence implies that the separability number as a method of determining stability reserve is dependable and sensitive. The higher the separability number, the more unstable is the fuel and this is the same for CII and Asphaltene-Resin ratio. The graphs show a close relation between the methods of stability reserve determination in fuel oils. Consequently, the CII and Asphaltene-Resin ratios can be used accurately to confirm the results of stability reserve by separability number. All the stability reserve predictions done by the separability number were correctly confirmed by the CCI. The Asphaltene-Resin ratio also confirmed four out of six tests correctly.

Separability number is a measure of how fast the asphaltenes phase separate from an oil solution on addition of light alkanes. In this regard, we do not expect any meaningful relation between asphaltene content and separability number. The relationship has more meaning if the peptizer (resins) are also included in the analysis since the ratio of asphaltenes to

resins in a given oil sample determines the stability of that particular fuel oil. Therefore, even though we see the asphaltene content decreasing as separability number is decreasing, it is not all conclusive to ascertain a relationship.

The American Institute gravity commonly referred to as the API gravity, is a measure of how light or heavy is a petroleum fluid in comparison to water. API gravity is an inverse measure of the relative density of a petroleum liquid and the density of water, but it is used to compare the relative densities of petroleum fluids. The greater the API gravity; the less dense is the petroleum liquid. The samples in this study have API gravity ranges from 12°-15°. It is noted that the asphaltenes are the heaviest, followed by resins, aromatics and lastly saturates. Apart from other solid particles that can be present in the oil or structurally embedded in the asphaltenes molecules, the asphaltene content has a direct bearing on the API gravity. As the amount of both resins and asphaltenes increase, the API gravity should increase. However, there is no direct evidence to suggest this hypothesis. As a result, more research should be done on this area to correctly relate API gravity with SARA fractions.

The experiments show that there is slight relation between API gravity and separability number. The samples with high API gravity showed low separability number. This can make us attempt to conclude that the lighter samples are more stable. However, the sample space is too small to make final conclusion. More data points should be used to arrive at a better conclusion.

#### IV. CONCLUSION

The use of stability Indices (Colloidal Instability Index and Asphaltene-Resin ratio) are very important in predicting the stability of asphaltenes in a given fuel oil sample. All the CII results corresponded with the results by separability number analysis. Only four stability reserve results for the marine fuel oils under investigation by Asphaltene -Resin ratio analysis corresponded with the results from separability number. The stability indices results proved that the method of NIR scanning is more sensitive and easy to use. The stability results by CII and Asphaltene-Resin ratios are directly related to the stability results by separability number. The higher the separability number; the higher the CII and Asphaltene-Resin ratio. The results of the relationship between asphaltene content and API gravity with separability number is not conclusive enough, more data points are needed to arrive at a better conclusion.

#### ACKNOWLEDGEMENT

This study was subsidized by the National High Technology Research and Development Program of China (863 Program) No. 2013AA040203

## REFERENCES

- [1] Pfeiffer J P, Saal R N J. Asphaltic bitumen as colloid system [J]. The Journal of Physical Chemistry, 1940, 44(2): 139-149.
- [2] Speight J G, Yen T F, Chilingarian G V. Asphaltenes and asphalts, 1[J]. TF Yen and GV Chilingarian, Eds, 1994:
- [3] Belhaj H, Khalifeh H A. Asphaltene Stability in Crude Oil during Production Process [J]. J Pet Environ Biotechnol, 2013, 4(142): doi:10.4172/21577463.1000142.
- [4] Maria Marioli, Asphaltenes characterization by Non Aqueous Capillary Electrophoresis. Master Thesis, Universiteit van Amsterdam, 2011.
- [5] Oliensis, G. L. (1935). Proceedings of Association of Asphalt Paving Technology. Vol 6, Issue 88. (1992).In: Howe-Grant, M. ed. Kirk-Othmer Encyclopedia of Chemical Technology, Vol. 3. 4th ed. p. 700.
- [6] Asomaning, S., Yen, A., Weispfenning, K., "Reducing the Viscosity of heavy oils with naphtha and its impact on asphaltene stability" ACS Symposium Series, 46, 2: 117,(2001)
- [7] Asomaning S. Test methods for determining asphaltene stability in crude oils [J]. Petroleum Science and technology, 2003, 21(3-4): 581-590.
- [8] Fan T, Wang J, Buckley J S. Evaluating crude oils by SARA analysis[C]//SPE/DOE Improved Oil Recovery Symposium. Society of Petroleum Engineers, 2002.
- [9] Alkafeef S F, Al-Medhadi F, AL-Shammari A D. Asphaltene remedial technology using advanced deasphalted oil [J]. Middle East Oil Show, 2003.
- [10] Otieno Odhiambo John, Wei HaiJun, Li PinYou and Jia FengGuang, Understanding Asphaltene Stability in Marine Fuel Oil Through Separability Number, Information Technology Journal 12(24), 8510-8513, 2013.

# A Review On Voltage Stability Improvement Using Artificial Neural Network Controlled FACTS Devices

Mutegi A. M, Muriithi C. M, Saulo M. J

**Abstract**— Power System Voltage stability remains a major challenge for power utilities across the world. This research seeks to come up with an optimal approach on the use of Flexible Alternating Current Transmission Systems (FACTS) devices for voltage stability improvement by taking into account the twin objectives of system security as well as system economy. This is based on a need to come up with a way of replacing human system operators so as to improve on real time system control. For this reason, the use of Artificial Neural Networks controlled FACTS devices shall be used. Security constrained optimal load flow solution shall be used to determine the best placement of the FACTS devices by taking into account maximum voltage stability enhancement as well as minimal increase in the system costs. Finally, a FACTS devices control system that employs Artificial Neural Networks shall be developed. This will be done on the IEEE 10 Generator 39 Bus system.

**Keywords**—Artificial Neural Networks, Economy, FACTS devices, Optimal, Security, Voltage Stability.

## I. INTRODUCTION

The demand for clean, reliable and affordable energy is growing at unprecedented rates across the world. As we seek to increase the quantity of energy produced, the supply quality challenges will grow in tandem. The growing long distances between generation and load centers only serve to compound the voltage stability challenge.

This presents power system engineering practitioners with the challenge of coming up with ways and means of maintaining the required system voltage profiles. Voltage stability is the ability of a power system to maintain acceptable voltage levels under normal operating conditions and after being subjected to disturbances such as a sudden increase in load [1].

Conventional voltage stability improvement methods such as capacitor banks, reactors and transformers can be used to provide steady state voltage control. However, these devices are based on electro-mechanical control among other

drawbacks thus impeding high speed control. This in essence means that they lack the much sought after traits of operational flexibility and versatility [2][3][4].

Due to their inherent advantages over the conventional voltage control methods, FACTS-Flexible Alternating Current Transmission System- devices have been increasingly used as an alternative over the years.

Research on the location of the FACTS devices using such methods as small signal analysis, hopf bifurcation, time domain analysis, loss sensitivity factors, fuzzy index, voltage change index as well as voltage stability index has been well documented. This has been coupled with various FACTS devices control strategies such as genetic algorithm, particle swarm optimization, pulse width modulation and runge-Kutta method [5][6][7][8].

Based on the above research findings, there is need for a different approach on the use of FACTS devices for voltage stability improvement by taking into account the twin objectives of system security as well as system economy. This is inspired by a need to try and come up with a way of replacing human system control operators so as to improve on real time system control as opposed to time delays experienced in relaying and actioning of instructions. It is for this reason that the use of artificial neural networks control strategy is proposed here. Artificial Neural Networks (ANN) are built to mimic the way biological nervous systems such as the brain process and act on information. Their main advantages are parallel computing as well as the ability to synthesize complex mappings accurately and rapidly as is the case with a real power system due to the complex interdependence of various system operating parameters [9].

It is viewed that coupling this with fast acting and versatile FACTS devices such as the unified power flow controller will go a long way in solving the challenge of voltage stability improvement in power systems.

The paper starts with a general introduction followed by the Mathematical Modelling of the Unified Power Flow Controller as well as the Artificial Neural Networks and lastly a look at the expected results.

## II. UNIFIED POWER FLOW CONTROLLER (UPFC)

The basic operating principle of an UPFC is as shown in

Mutegi A.M, Department of Electrical Engineering, JKUAT (+254 720 92 35 35; arielmutegi@yahoo.com).

Muriithi C.M, Department of Electrical Engineering, TUK (cmmainamuriithi@gmail.com).

Saulo M.J, Department of Electrical Engineering, TUM (michaelsaulo@yahoo.com).

figure 1 below.

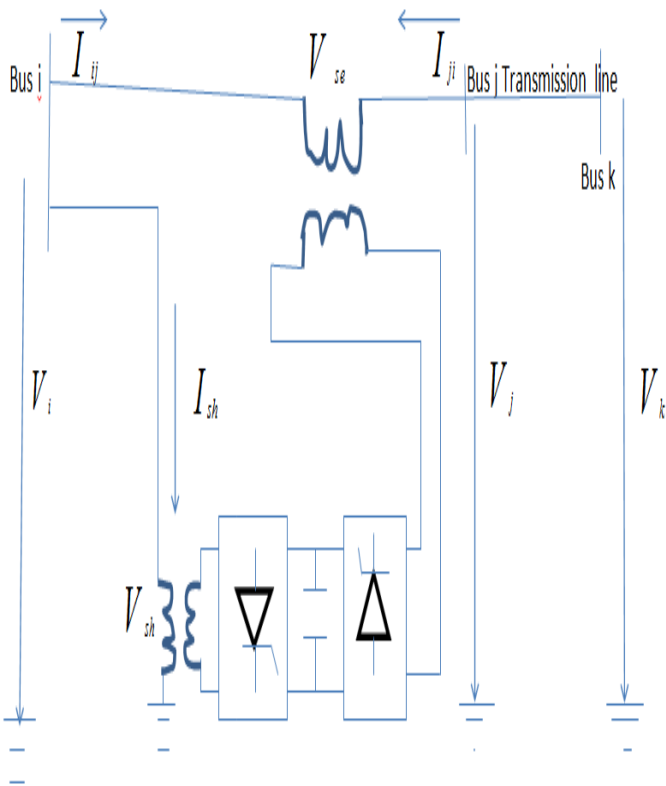

Fig.1 Operating Principle of UPFC

The UPFC consists of two switching converters based on Voltage Source Converter valves connected by a common DC link [10][11][12][13][14][15]. Based on Fig.1 above an equivalent circuit as shown in Fig.2 below can be established.

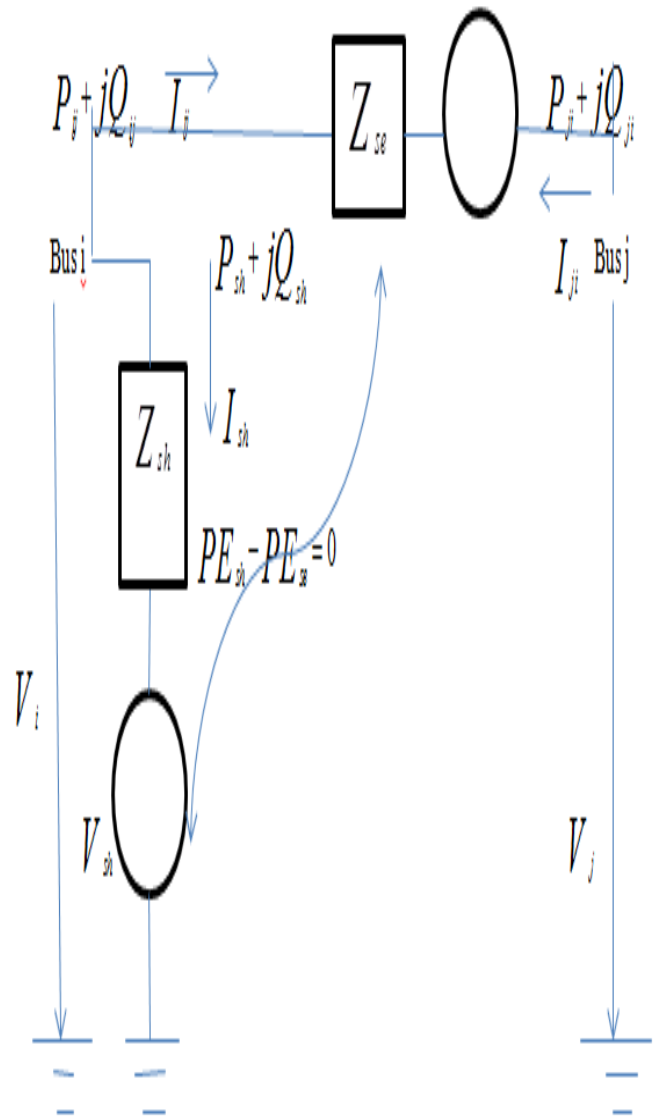

Fig.2 Equivalent circuit of UPFC

In Fig.2, the phasors  $V_{sh}$  and  $V_{se}$  represent the equivalent injected shunt and series voltages respectively and  $Z_{sh}$  and  $Z_{se}$  are the UPFC series and shunt coupling transformer impedances respectively.

$V_i$  and  $V_j$  are the voltages at buses  $i,j$  respectively while  $V_k$  is the voltage of bus  $k$  of the receiving-end of the line.  $I_{sh}$  is the current through the UPFC shunt converter.  $P_{sh}$  and  $Q_{sh}$  are the shunt converter branch active and reactive power flows respectively.  $I_{ij}$  and  $I_{ji}$  are the currents through the UPFC series converter.  $P_{ij}$  and  $Q_{ij}$  are the UPFC series active and reactive power flows respectively leaving bus  $i$ .  $P_{se}$  is the real power exchange of the series converter with the DC link.

For the equivalent circuit of UPFC in Fig.2,if

$$V_{sh} = V_{sh} < \theta_{sh}$$

$$V_{se} = V_{se} < \theta_{se}$$

$$V_i = V_i < \theta_i$$

$$V_j = V_j < \theta_j$$

then the power flow constraints of the UPFC shunt and series branches are:

$$P_{sh} = V_i^2 g_{sh} - V_i V_{sh} \{g_{sh} \cos(\theta_i - \theta_{sh}) + b_{sh} \sin(\theta_i - \theta_{sh})\} \quad (1)$$

$$Q_{sh} = -V_i^2 b_{sh} - V_i V_{sh} \{g_{sh} \sin(\theta_i - \theta_{sh}) - b_{sh} \cos(\theta_i - \theta_{sh})\} \quad (2)$$

$$P_{ij} = V_i^2 g_{ij} - V_i V_j (g_{ij} \cos \theta_{ij} + b_{ij} \sin \theta_{ij}) - V_i V_{se} \{g_{ij} \cos(\theta_i - \theta_{se}) + b_{ij} \sin(\theta_i - \theta_{se})\} \quad (3)$$

$$Q_{ij} = -V_i^2 b_{ij} - V_i V_j (g_{ij} \sin \theta_{ij} - b_{ij} \cos \theta_{ij}) - V_i V_{se} \{g_{ij} \sin(\theta_i - \theta_{se}) - b_{ij} \cos(\theta_i - \theta_{se})\} \quad (4)$$

$$P_{ji} = V_j^2 g_{ij} - V_i V_j (g_{ij} \cos \theta_{ji} + b_{ij} \sin \theta_{ji}) + V_j V_{se} \{g_{ij} \cos(\theta_j - \theta_{se}) + b_{ij} \sin(\theta_j - \theta_{se})\} \quad (5)$$

$$Q_{ji} = -V_j^2 b_{ij} - V_i V_j (g_{ij} \sin \theta_{ji} - b_{ij} \cos \theta_{ji}) + V_j V_{se} \{g_{ij} \sin(\theta_j - \theta_{se}) - b_{ij} \cos(\theta_j - \theta_{se})\} \quad (6)$$

where  $g_{sh} + jb_{sh} = 1/Z_{sh}$ ,  $g_{ij} + jb_{ij} = 1/Z_{se}$ ,  $\theta_{ij} = \theta_i - \theta_j$ ,  $\theta_{ji} = \theta_j - \theta_i$

### III. ARTIFICIAL NEURAL NETWORKS

Fig.3 below shows a schematic diagram of Artificial Neural Networks. The inputs are normally weighted against a given modifiable parameter so that one is able to control the output depending on the activation function [9][16].

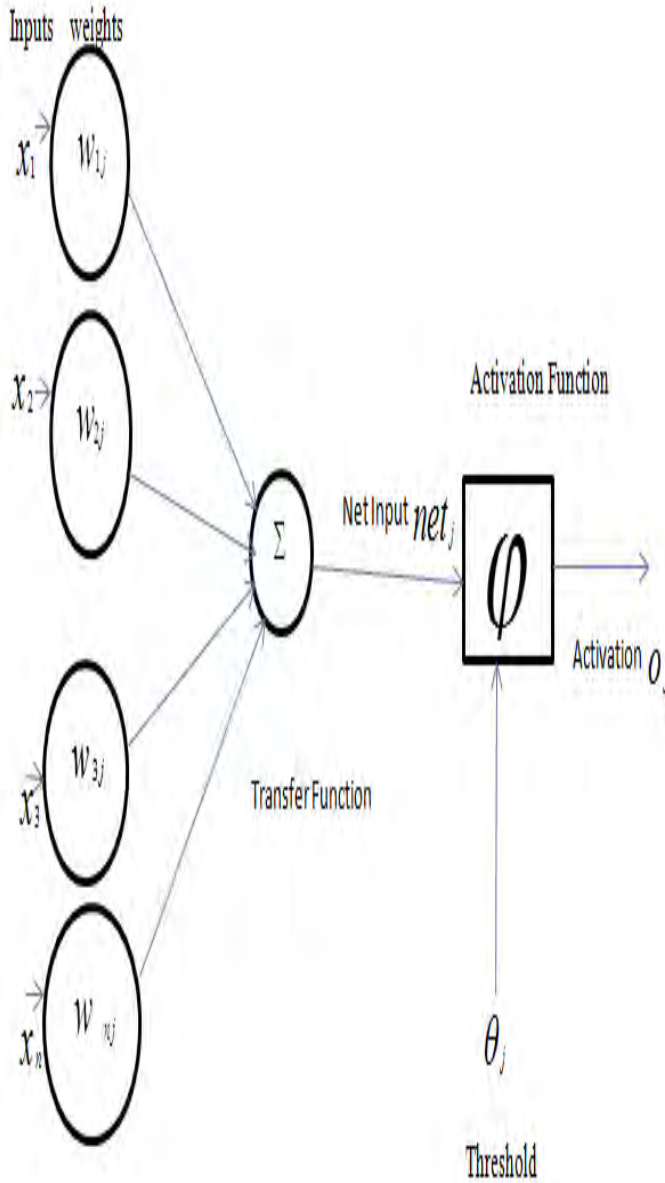

Fig.3: ANN schematic diagram

This allows for non-linear learning and noise tolerance, a great advantage when working with power systems which are inherently non-linear.

The ANN will be trained against a collection of possible ordered observations  $(x_1, x_2, \dots, x_t)$  whereas in this case, the observations will be various voltage levels and the action to take in terms of injection or absorption of reactive power. A time series model  $(\hat{x}_t)$  assumes that the observations are dependent. The aim of a forecasting model is to capture the behaviour of a complex phenomenon such as a power

system and not the cause-and-effect relationships of its main components.

We shall use the holt-winters forecasting technique, a function of the exponential smoothing techniques based on the four equations below:

$$F_t = \alpha \frac{x_t}{S_{t-k}} + (1-\alpha)(F_{t-1} + T_{t-1})$$

$$T_t = \beta(F_t - F_{t-1}) + (1-\beta)T_{t-1}$$

$$S_t = \gamma \frac{x_t}{F_t} + (1-\gamma)S_{t-k}$$

$$\hat{x}_t = (F_{t-1} + T_{t-1})S_{t-k}$$

(7)

Where  $F_t$ ,  $S_t$ , and  $T_t$  denote the smoothing, general trend and long range estimates,  $k$  the long range period and  $\alpha$ ,  $\beta$  and  $\gamma$  the model parameters set by trial and error procedures during the actual system training.

### IV. EXPECTED RESULTS

The security constrained optimal load flow solution on the IEEE 10 Generators 39 bus system as shown in Fig.A1 below shall be used to identify the most suitable location of the FACTS devices.

It is expected that the weak and heavily loaded buses for optimal FACTS devices placement using the set system security constraints will be identified using a ranking system for sensitivity indices on the buses.

This will assist to achieve the twin goals of economy and security of the power system. Here, the constraints will be minimization of real power losses, minimization of the cost of active power generation, minimization of reactive power losses for better voltage profiles, maximization of active power transfers and minimizing the cost of installation of the FACTS devices.

The flow chart below summarizes the work to be done:

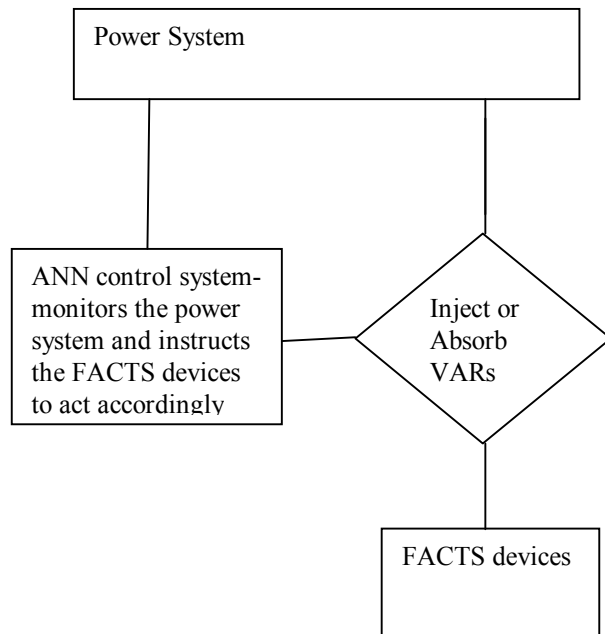

Fig.4 Proposed Research Block diagram

We expect to come up with a robust system to better control the operation of the FACTS devices as desired for better regulation of power system's voltage stability in real time. The trained ANN shall continuously monitor the system in real time and instruct the FACT device(s) to act accordingly as per the system conditions described above with the overall aim being to regulate the voltage within defined limits.

## REFERENCES

- [1] P.Kundur, "Control of Active Power and Reactive Power, "in Power System Stability and Control, 2nd ed. British Columbia, Canada: McGraw-Hill Inc., 1994, ch.14, sec.1, pp.959-969.
- [2] P.Kundur, "Control of Active Power and Reactive Power, "in Power System Stability and Control, 2nd ed. British Columbia, Canada: McGraw-Hill Inc., 1994, ch.11, sec.2, pp.628-639.
- [3] Reactive Power Management and Voltage Control in North Eastern Region, 4th ed., Power System Operation Co., Lalapang, Dongtiah-Lower Nongrah, India, 2012, pp.6-86.
- [4] Reactive Power Compensation of Transmission Lines, 2nd ed., Concordia University, Mequon, Wisconsin, 2009, pp.1-14.
- [5] Vibhor Gupta "Study and Effects of UPFC and its control system for Power Flow control and Voltage Injection in a Power System," Journal of Eng.Sc. and Tech., vol.2, no.7, pp. 2558-2566, Jul.2010.
- [6] Panumat Sanpoung, "Analysis and control of UPFC for voltage compensation using ATP/EMTP," Asian Journal on Energy and Environ., vol.10, no.4, pp.241-249, Jun.2009.
- [7] P.S.Venkataramu and T.Ananthapadmanabha "Installation of unified power flow controller for voltage stability margin enhancement under line outage contingencies," Iranian Journal of Elect. and Computer Eng., vol.5, no.2 pp. 90-96, Dec.2006.
- [8] K Manoz Kumar Reddy "Transmission Loss Minimization Using Advanced Unified Power Flow Controller-UPFC," IOSR Journal of Eng., vol.2, no.2, pp. 1049-1052, May 2012.
- [9] Juan Rabunal and Julian Dorado, Artificial Neural Networks in Real-life Applications (Book style). London:2006, ch.3.

- [10] K.R Padiyar and A.M Kulkarni, "Control Design and Simulation of UPFC," Proc. IEEE vol.13, pp.1348-1354, Oct.1998.
- [11] Sunil Kumar, "Transmission Loss Allocation and Loss Minimization by incorporating UPFC in LFA," Int. Journal of Mod. Eng. Res.vol.1, no. 1, pp.236-245, Apr.2011.
- [12] B.A Renz, "AEP Unified Power Flow Controller Performance," Proc.IEEE vol.14 No.4, pp. 1374-1380, Oct. 1999.
- [13] S.Tara Kalyani and G.Tulasiram Das "Simulation of real and reactive power flow control with UPFC connected to a Transmission Line," Journal of Theor. and Appl. Inf. Tech., pp. 16-22, Jul.2008.
- [14] Fundamentals of Power Engineering: Lecture 10-Power flow studies, 2nd ed., Lamar University, Beaumont, Texas, 2009, pp.1-14.
- [15] Xiao-Ping Zhang, Christian Rehtanz and Bikash Pal, Flexible AC Transmission Systems: Modelling and Control (Book style). Springer-Verlag, Germany: 2006, pp. 59-70.
- [16] Christos Stergiou and Dimitrios Siganos. (2009, April 15). Neural Networks (2nd ed.) [online]. Available: [http://www.doc.ic.ac.uk/~nd/surprise\\_96/journal/vol4/cs11/report.html](http://www.doc.ic.ac.uk/~nd/surprise_96/journal/vol4/cs11/report.html)

APPENDIX

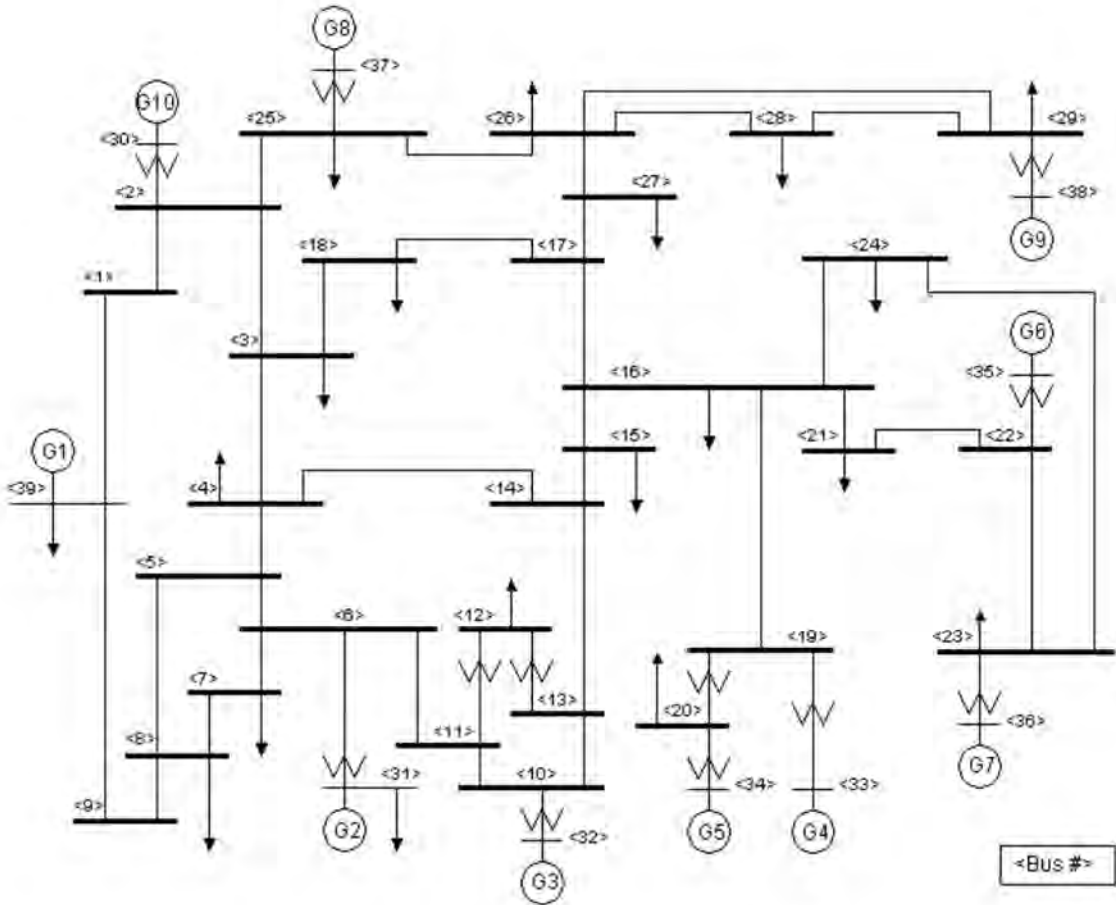



# Improved biogas production over immobilised methanogenic consortia.

A. Chirchir, A. Aoyi, K. Kiriamiti and A. Kumar

**Abstract**— Alcohol distilleries produce effluents which are strongly acidic, have high Chemical Oxygen Demand (COD) and Biochemical Oxygen Demand (BOD), contain strong odour and are dark brown in colour. They cause detrimental environmental effects if they are freely disposed off to the environment. Adopted anaerobic treatment techniques with associated biogas generation have not proved to be very efficient on high strength distillery effluents as substrates. The improvement on mean product yield, effluent stabilization and sterile air tolerance was explored through microbial immobilization on activated natural zeolite and calcium alginate supports. Three experimental set-ups were performed with the first acting as a control and having no support material whereas the second and third having microbial system immobilized unto activated natural zeolite and calcium alginate supports respectively. At the marginal organic loading of  $75 \text{ kg/m}^3$  (corresponding to undiluted waste water), the unsupported system showed a low yield of  $2.1 \times 10^{-3} \text{ m}^3/\text{kg COD}_t$  in biogas, whereas the calcium alginate system registered the highest yield of  $84.5 \times 10^{-3} \text{ m}^3/\text{kg COD}_t$ . Activated natural zeolite system on the other hand showed a yield of  $43.6 \times 10^{-3} \text{ m}^3/\text{kg COD}_t$ . Based on the effluent stabilization over the same initial marginal organic loading, activated natural zeolite system demonstrated the highest degree in effluent stabilization of 44.0 % as opposed to the unsupported and the calcium alginate system that registered 24.0 % and 41.3 % respectively. Finally, activated natural zeolite supported system showed the longest tolerance to sterile air exposures of 90 minutes. The unsupported system registered a tolerance of 30 minutes whereas the calcium alginate system demonstrated 60 minutes of oxygen tolerance.

**Keywords**— Consortia, effluent stabilization, immobilisation, initial organic loading ( $\text{COD}_t$ ), product yield and sterile air tolerance.

## I. INTRODUCTION

Sugar cane molasses are by-products of the sugar-extraction processes and are often used as raw materials in alcohol distilleries. The production of vinasses in a traditional alcohol factory is in the range of 8–15 litres of molasses wastewaters per litre of ethanol obtained [1]. These wastes are strongly acidic (pH 4–5), have a high-organic content, chemical

oxygen demand (COD in the range of 80–100 g/l) and biochemical oxygen demand (BOD) (40–50 g/l), strong odor and dark brown color [2]. Their free disposal presents a serious challenge to the natural ecosystem and can cause considerable environmental problems [1]. Apart from high organic content, distillery wastewater also contain nutrients in the form of nitrogen (1660–4200 mg/l), phosphorus (225–3038 mg/l) and potassium (9600–17,475 mg/l) that can lead to eutrophication of water bodies. Further, its dark color hinders photosynthesis by blocking sunlight and is therefore deleterious to aquatic life [2].

In the treatment of these wastes, anaerobic digestion is the most preferred because it utilizes low energy input, has high transformation of the organic matter by anaerobic bacteria into biogas, has minimal sludge formation and require low nutrient demands.

The production of biogas enables the process to generate energy in addition to the reduced energy uptake [3][4].

However, the dark color remains a problem after anaerobic treatment, which therefore requires a pre-treatment before its safe disposal into the environment [5]. The presence of inhibitory substances such as phenolic compounds severely hinders the anaerobic process. They slow down the kinetics, increases acclimatization periods and reduces mean rates of methane production, and yield coefficients [3]. These limitations then dictate the utilization of high hydraulic retention times (HRT). Many phenolic compounds are known to be toxic and interfere with the activity of methanogenic bacteria. In addition, the high salinity of this waste (average conductivity of 40 mS/cm) also causes osmotic pressure problem to the micro-organisms responsible for the anaerobic process [3].

Currently, there are no conventionally agreed design of a commercial process that is able to work on high strength waste water and effectively reduce both BOD and COD.

This project therefore, examined the possibilities of improving biogas production from molasses waste water via immobilized methanogens on zeolite and calcium alginate gel supports. This approach was designed so as to improve on the methane production volumes, facilitate high effluent stabilization, enhance the use of high strength influents, suppress salinity problems and impart high process tolerances to external disturbances like oxygen seepage into the process.

A. K. Chirchir and A. Kumar, Department of Chemical and Process Engineering, Moi University (corresponding author: Chirchir phone: +25407215235170; e-mail: tabokiat@yahoo.com).

A. Aoyi, Department of Chemical Engineering, Vaal University of Technology (aoyio@yahoo.com).

K. Kiriamiti, Deputy Principle, Garissa University College (kiriamiti@yahoo.com).

## II. MATERIALS AND METHODS

### A. Inoculum and Waste Water

The cultivation substrate used was collected from temperature stabilization lagoons in Agro-Chemicals Ltd., Muhoroni, Kenya. The samples were maintained at a temperature of about 4 °C throughout the transit period. It was then characterized for: pH, Dissolved oxygen (DO), Chemical oxygen demand (COD), Biological oxygen demand (BOD), Total solids (TS), Total suspended solids (TSS) and Total nitrogen (TN).

The determination of the pH was done by glass electrode apparatus, with hydrogen ion responsive electrode as the sensing element. The meter type used was Hanna, HI 2211 pH/ORP type. The COD was determined using closed reflux chrome colorimetric technique.

In the BOD measurements, the DO was determined instrumentally using, Hanna HI 9142 dissolved oxygen meter. 1.5 ml effluent of the Moi University aerobic biological lagoon was used for seeding. After the five days, the DO content of the incubated samples of the set were determined and following relation was used in the calculation:

$$BOD \text{ in mg per litre (5 days } 20^{\circ}C) = \frac{(DO_0 - DO_5 - B) \times 100}{\% \text{ of the sample used}}$$

Where:  $DO_0$  = was initial DO content in mg/l

$DO_5$  = DO content after 5 day incubation

$B$  = Blank correction determined by the difference in the DO contents of the blank at start of the incubation and after the 5 day incubation period.

In the total solids determination, samples were dried in an oven at 105 °C until there were no more changes in their weights. The differences in their weights were then determined.

Suspended solids content was measured through the filtration of samples followed by drying the cake at 105 °C until constant weights were obtained.

Total nitrogen was determined using potassium persulfate digestion under alkaline conditions. The persulfate oxidation technique for total nitrogen in waste water was performed under heated alkaline conditions in an autoclave at 120 °C. The digested sample was then analysed for nitrate using Shimadzu UV-VIS spectrophotometer. The obtained absorbance was then interpreted on a standard curve earlier prepared.

### B. Preparation and Characterization of the Immobilization Media.

The sodium alginate gel was purchased from Sigma Aldrich Co. Ltd as powder and no prior preparation was required as it was relatively in its pure form.

Clinoptilolite was purchased from Jax Industries, South Africa in its raw form. It was double washed, air dried, milled and sieved to particle size ranges of 150-300 µm.

The activation of cleaned clinoptilolite was done using 2 M NaCl solution. 100g of the cleaned and air-dried natural zeolite was measured and added to 2 M NaCl solution then stirred continuously at 250 rpm for 72 hours. The solution then vacuum filtered. The now conditioned natural zeolite was then double washed with distilled water to remove the residual NaCl. Finally, it was again vacuum filtered and air-dried for 24 hours.

However, adsorption capacity was determined in this study through experiments. The adsorption capacity of the activated natural zeolite was then carried out where batch experiments were carried out using 100 ml stoppered conical flasks containing 50 ml of the inoculum having a concentration of 10 g/L biomass peptides measured as amino acids in solution. To this solution, 5 g of the conditioned natural zeolite was added and stirred at 250 rpm for 24 hours.

The solution was then vacuum filtered and the cake re-suspended in 100 ml of distilled water. The suspension was once again vacuum filtered and the filtrates from the two stages were mixed and biomass amino acid concentration was again determined. The final mass of biomass peptide in the filtrate was then calculated and the carrying capacity of the activated clinoptilolite determined.

### C. Cultivation and Immobilization of the Mixed Methanogenic Consortium Inoculum

The mixed methanogenic culture used in the experiment was isolated from anaerobic digester sludge obtained from Agro-chemical Ltd. It was enriched and maintained in a fresh anaerobic growth medium containing the constituents shown in table I

TABLE I  
MICROBIAL GROWTH MEDIUM.

Component	Amount	Function of component
Vinasse	50 g	C and energy source
K <sub>2</sub> HPO <sub>4</sub>	25 g	pH buffer; P and K source
KH <sub>2</sub> PO <sub>4</sub>	20 g	pH buffer; P and K source
CaCl <sub>2</sub>	1.0 g	Ca <sup>2+</sup> source
MgSO <sub>4</sub> 7H <sub>2</sub> O	5.0 g	S and Mg <sup>++</sup> source
FeSO <sub>4</sub> 7H <sub>2</sub> O	0.1 g	Fe <sup>++</sup> source

MnSO <sub>4</sub> 7H <sub>2</sub> O	0.05 g	Mn <sup>++</sup> Source
CaCl <sub>2</sub> 6H <sub>2</sub> O	0.1 g	Ca <sup>2+</sup> source
AlK(SO <sub>4</sub> ) <sub>2</sub> 12H <sub>2</sub> O	0.01 g	Al <sup>3+</sup> and K <sup>+</sup> source
NH <sub>4</sub> Cl	1.0 g	N source
Water	Top up to 1 litre	Dissolving solution
pH	7.0	

Enrichment involved the collection of the cells by centrifugation at 5000 g for 20 minutes under anaerobic conditions. The enriched methanogenic culture was adapted to the substrate in a batch reactor under strict anaerobic conditions at 40°C.

The concentration and viability of the cells was monitored both by tracking the biogas produced and performing the biomass amino acid content test (6) using Lowry procedure.

The Lowry procedure involved the reaction of the peptide nitrogen with the copper (II) ions under alkaline conditions and the subsequent reduction of the Folin-Ciocalteayphosphomolybdciphotungstic acid to heteropolymolybdenum blue by the copper-catalyzed oxidation of aromatic acids.

This reaction was accompanied by colour change which corresponds to the amount of amino acids initially present. The absorbance of the reduced solution was then measured using Shimadzu Double Beam, UV-VIS spectrophotometer at a wavelength of 600 nm.

The final enriched methanogenic consortium was adjusted to a polypeptide concentration of 10 g/L and stored in a deep freezer at temperatures of below 4 °C.

The immobilization of the mixed methanogenic consortium onto an activated natural zeolite support involved batch processes. The enriched methanogenic population at a concentration of 10 g/L polypeptides was suspended and washed in an oxygen-free phosphate buffer, and its concentration adjusted using a buffer to 10 mg protein per ml. The obtained suspension was then added to the pre-activated natural zeolite support and stirred anaerobically for 24 hours at 25 °C. The immobilized biomass was then repeatedly washed with a sterilized nutrient solution until no free biomass in the washing waters was observed. Concentration of biomass before and after adsorption was monitored.

10 g of the now immobilized biomass obtained by centrifugation was then used to inoculate each of the batch reactors in the biomethanation stage.

The immobilization of the enriched and adapted methanogenic consortium into calcium alginate beads involved the cross-linkage formations that result into micro-porous micelles around the capsule surfaces. This process was

carried out by dissolving 9 g of sodium alginate powder in 300 ml of the enriched methanogenic consortium prepared to contain 10 mg/L of polypeptide biomass. The solution was then stirred anaerobically. The final solution contained about 3% alginate by weight. In an inert environment, the cell-sodium alginate mixture was dripped from a height of 20 cm using a syringe into 1000 ml 0.05M of CaCl<sub>2</sub> to allow the cross-linking formations to commence. The mixture was then stirred for 1 hour using a magnetic stirrer. Gel formation was achieved as soon as the sodium alginate drops come into direct contact with the calcium chloride solution but it took about 1 hour for the formed beads to case-harden. The beads were then washed with a fresh calcium chloride crosslinking solution. 20g of the calcium alginate immobilized mixed methanogenic consortium were then measured and inoculated into the batch reactors in the biomethanation stage.

#### *D. Batch Studies of the Biogas Generation*

Three experimental sets of batch processes were conducted in the biomethanation, where in each set, there were four individual runs. The first set contained the culture medium and the inoculum without the support material whereas the second and third sets contained activated natural zeolite and the calcium alginate material as supports respectively. The optimal parameters studied included the initial organic loading, the biomethanation time change and sterile air exposure intervals required to cause irreversible change in the biochemical activities. The first set acted as a control experiment. The dependant output variables of greatest importance were the levels of residual COD at equilibrium and the ultimate cumulative amount of biogas generated.

#### *Optimum Organic Loading*

To each set of experiment, variations of the organic loading measured in terms of COD was done over four intervals of 0, 25, 50 and 75 kg/m<sup>3</sup> (or g/L) at a mesophilic temperature range of 40 °C. The contact time was allowed to be constant at the maximum level where equilibrium of the slowest reaction was attained. The optimal pH of the mixture was also set at the initially pre-determined value of 7.0. The agitation rate was a moderate shaking for 10 minutes over intervals of 8 hours. The optimum initial organic loading was then calculated in terms two output variables: the highest yield realized and the highest percentage of waste water stabilization.

#### *Oxygen Tolerance Levels*

A second set of experiments having the pre-determined optimal organic loading was set up so as to test the system resilience to accidental or deliberate oxygen exposures. Each system was set at a pH of 7.0 over mesophilic temperature range of 40 °C. Eight experimental set ups were done in each factor chosen and the oxygen tolerance levels in each was performed. When the system attained the pseudo-steady state at the exponential phase of microbial growth, sterile air-bubbling was performed on each of the set-up at different exposure intervals. The intervals of exposure for eight experiments of the three sets were of: 15, 30, 45, 60, 75, 90, 105 and 120 minutes.

### E. Instrumental and Quantitative Chemical Analysis

The initial and residual COD levels were digested in a Hanna block digester and the resultant digestate was measured using UV-VIS Double Beam Spectrophotometer at a wavelength of 600 nm. The inferential relationship between organic load concentration and absorbance was predetermined by calibration using potassium hydrogen phthalate standard solution. The COD calibration curve was then therefore generated. The polypeptide content was measured using Lowry procedure whereby the incubated solution was tested for absorbance using a UV-VIS Double Beam Spectrophotometer at a wavelength of 600 nm. The inferential relationship between polypeptide concentration and absorbance was predetermined by calibration using bovine serum albumin standard at an alkaline environment.

## III. RESULTS AND DISCUSSION

### A. Batch Studies of Biogas Generation

Information on the batch studies of biomethanation was important in the evaluation of the net effects of using various support materials. The parameters targeted to point-out the performance of each supported system were the degree of substrate conversion, the biogas yield per unit organic loading and the oxygen tolerance levels.

### B. Kinetics of Biogas Production over Different Support Materials in a Batch System

Each support material was studied differently and comparisons were made with the unsupported system acting as the datum. The kinetics of biogas production in the unsupported system is shown in figure 1

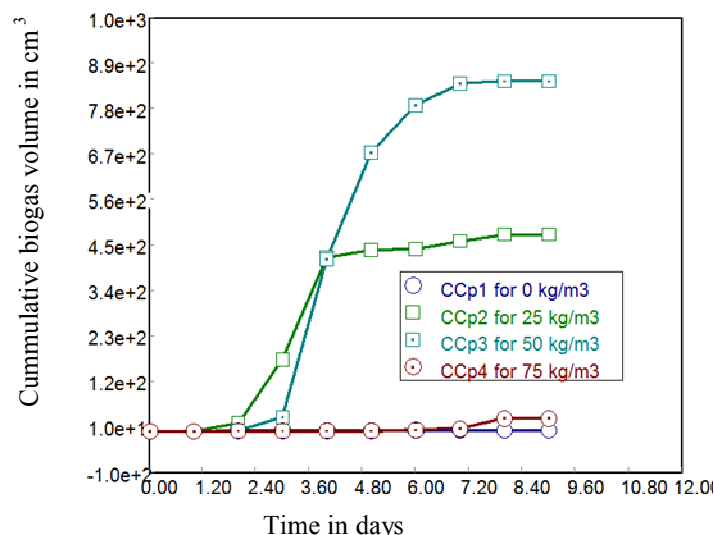

Fig. 1 Kinetics of biogas production over unsupported biomass

The cumulative biogas produced by the system having an initial COD of 0 kg/m<sup>3</sup> showed virtually no response as there were no carbon sources in the substrate to be converted to biogas. On the other hand, the system having initial organic loading of 25 kg/m<sup>3</sup> showed a quick response and also approached the equilibrium faster than the other systems. This could be attributed to the balanced state of the system whereby the driving forces were ideal for microbial growth. The forces in action in the system were the osmotic pressures controlled by the degree of electrolytes present in the system and the growth limiting substrates available. Other additional growth limiting parameters could involve inhibitors like the phenolic compounds, alcohols, quaternary ammonium compounds, aldehydes and bacteriocidal agents present [7] and [8]. The system with an initial COD of 50 kg/m<sup>3</sup> showed a moderate rate of response although it approached equilibrium slowly compared to that of COD 25 kg/m<sup>3</sup>. This behavior could have been due to a tolerable level of electrolytes as well as a stoichiometrically equivalent substrate that never limited the biomass growth. Lastly, the system containing initial COD levels of 75 kg/m<sup>3</sup> exhibited an almost zero response in terms of biogas generation. This could be as a result of the high salinity in the substrate posing osmotic pressure problems to the microbial system. According to [7], when the system has different electrolyte concentration from its environment, and is separated by a semi-permeable polymeric membrane, there will always be a flow of pure water in the direction of increasing concentration. The trend is towards equalizing the concentration of solutes on either side of the membrane. The microbial cells have a solute concentration of nearly 0.95% and anything higher on the external environment will make the microbial cells shrink

and cause plasmolysis. The system that was considered had a solute concentration of 7.2 % which was definitely higher than that inside the cells. Certainly, plasmolysis occurred and prevented the growth of methanogenic consortium. Besides that, the system could also have had growth limiting substrate concentrations being very high as to inhibit the normal growth. According to [7], microbial growth rate gets inhibited due to the high concentration of substrates. The substrate inhibition phenomenon can be competitive or non-competitive. If a single substrate enzyme catalysed reaction is the rate limiting step in the microbial growth, then the inhibition of the enzyme activity results in the inhibition microbial growth by the same pattern.

In the activated natural zeolite supported system, the phenomenon was almost similar to the unsupported system safe for a few variations shown in figure 3.2. The most predominant feature that showed a marked deviation from the unsupported system was the short lag phase in the system. This could be due to the reduced effect of inhibiting substances present in the medium due to the tortorosity of the pores. The narrow pores present in the zeolite structure created safe dens for microbial population to be shielded from the adverse surrounding environment. The solution surrounding the microbes would in-turn be diluted of inhibitory substances because of the diffusive interchange between the fresh substrate and the metabolic wastes of microbial excretion. This led to the high rates of product formation and generally shorter intervals of equilibrium establishment.

It was also noted from figure 2 that the regime of approach of equilibrium was rather sharp as opposed to the sluggish one witnessed in the unsupported system in figure 1. The rapid decline in the mean rates of biogas production could be attributed to the limiting substrate exhaustion in the culture

media [7]. A big observation was manifested in the system containing a high strength waste water of COD 75 kg/m<sup>3</sup> which in essence was barely undiluted. Unlike in the unsupported system, the set-up registered production of large volumes of biogas on the 9<sup>th</sup> day. These phenomena corroborated the fact that indeed the microbial system appeared to be more protected from the harsh environment of the culture media through porous supports. Validation of this phenomenon can be obtained by mass transfer studies of the known inhibitors present in the culture media across zeolite supported systems.

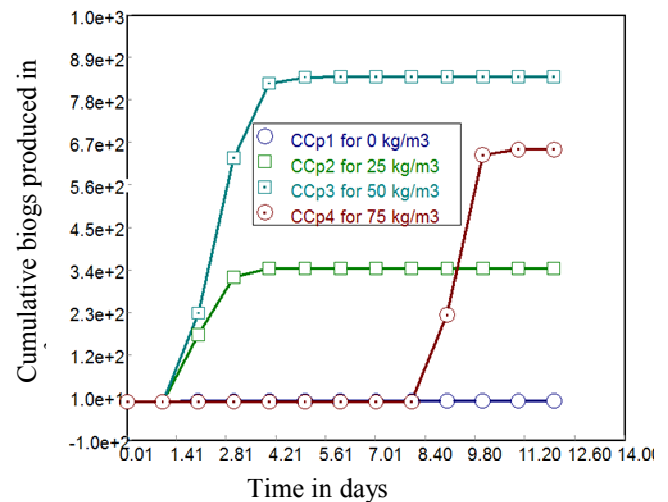

Fig.2 Kinetics of biogas production over activated natural zeolite supported system

With regards to the calcium alginate supported system, notable observations were made. There was a very rapid response time and almost zero lag phase in the low strength supported systems. This behavior signified high adaptability to the substrate by the consortium.

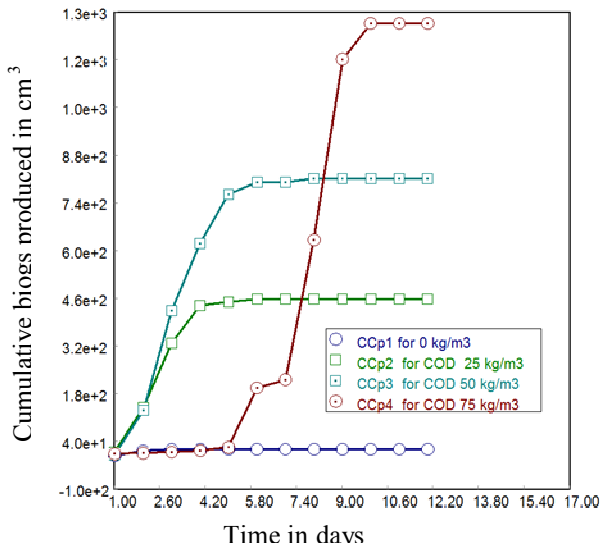

Fig. 3 Kinetics of biogas production over calcium alginate supported system

There was also a very sharp approach to the equilibrium state which could have been caused by the exhaustion of the growth limiting substrate. All the curves except the one having a COD of  $0 \text{ kg/m}^3$ , were observed to display discontinuous sections in which continuity of the curve was sharply distorted. This behaviour was in synchrony with the observed phenomenon whereby the calcium alginate beads dissolved in all the set-ups between the second and third days. Upon this occurrence, the microbial population was emptied into the surrounding culture media. Since the methanogenic consortium hadn't well adapted to the harsh external environment away from the capsules, their viability must have been disoriented and this fact could have occasioned the rapid changes in the product generation kinetics. In comparison with the unsupported system, there appeared to be an enhanced biochemical activity in the calcium alginate supported system. This behavior could be explained by consideration of the bead structure and their microbial immobilization mechanism. In this immobilization technique, microbial population are entrapped inside capsule-like balls formed by a semi-permeable polymeric membrane in which the walls are cross-linked by active joint sodium metal ion displacement reaction with ionized calcium in solution. The calcium ion replaces the sodium ion in the joint to form a non-soluble cross-linked mesh at the bead case that is permeable to most substrates. The membrane must have offered resistance to mass transport across it. The free movement and intimate mixing between the substrates and the microbial system was slowed down and most of the processes inside the balls took place in an unsteady state

regime. The kinetics of this unsteady state operation depended on a number of factors that included the pore structure of the beads, the thickness of the membrane, strength of the substrates, residual pore charges, and biochemical kinetics inside the beads among other factors. The overall mass transfer behavior with respect to the biochemical reaction kinetics should be studied in order to explain some of the observed unclear phenomenon.

### C. Kinetics of Substrate Utilization over Different Support Materials in a Batch System

The kinetic substrate utilisation in the unsupported system is shown in figure 4. Since the system containing initial COD of  $0 \text{ kg/m}^3$  had no organic matter, there was no decline in the COD levels. The set-up with an initial COD level of  $50 \text{ kg/m}^3$  exhibited a drastic decline in the residual levels in synchrony with the biogas volumes that was generated. The reason for the drastic decline was due to the balanced growth requirements which the system had. The symbiotic relationship between the hydrolytic, acetogenic, acidogenic and methanogenic microbial systems was at balance and therefore the result was a synergistic display of the consortium interaction.

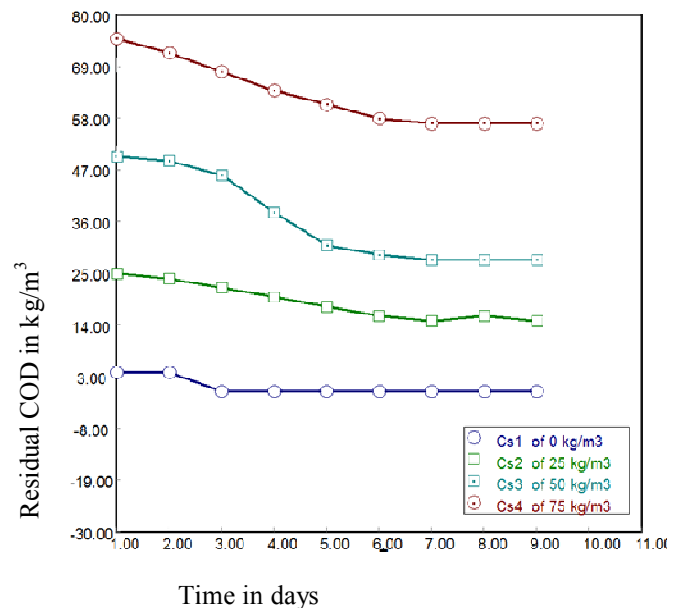

Fig. 4 kinetics of substrate utilization over unsupported system

In the case of the system with initial COD of  $75 \text{ kg/m}^3$ , there was an anomalous display of reduction in the residual COD, which was out of synchrony with the respective biogas produced. This could be explained by consideration of the biomass growth. The utilization of substrate was directed

towards endogenic respiration of the microbial population and cell complexation, a process that was not directly associated with the product formation [7]. It is also not worthy that the residual COD reduction in this case was not at a very high percentage.

In the case of the activated natural zeolite supported system, the system exhibited a similar trend with a few variations. The systems containing initial COD 50 and 75 kg/m<sup>3</sup> demonstrated a more pronounced reduction in the COD. Also the response to this substrate utilization was sharper than the unsupported system.

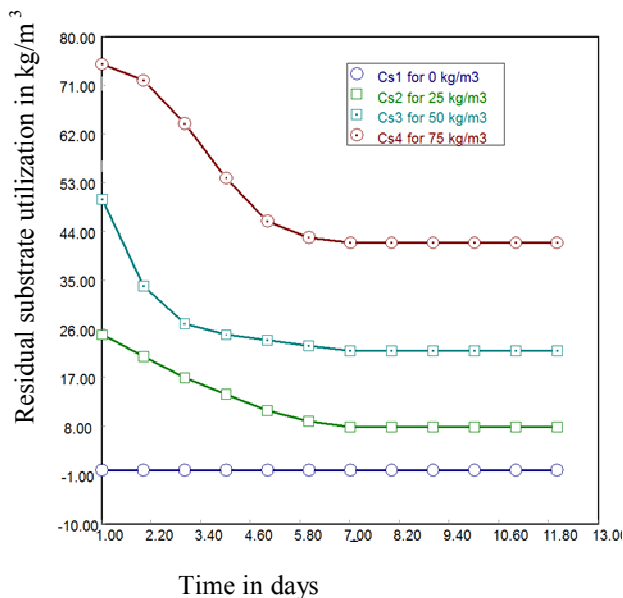

Fig.5 Kinetics of substrate reduction on activated natural zeolite supported system

This could only be possible with the reduced effects of inhibitors and a proper symbiotic relationship between microbial systems just as discussed in section B.

The most predominant variation between the two systems is the big slump in the activated natural zeolite supported system containing the initial COD of 75 kg/m<sup>3</sup>. This is corroborated by the high volume of biogas generated in this set-up amidst the long lag phase. Most of the substrate consumed went into the formation of the product besides some going into the endogenic respiration. The long lag phase was due to the initial harsh environments surrounding the microbes before the eventual dilution of toxins and substrates by the diffusive interchange between the excreted and fresh products. The diffusional resistances imparted great effects on the final kinetics of biomethanation. Adsorbents tend to increase the size of the stagnant layer

around the immobilized system. The rate of mixing may not easily interfere with this stagnant film, thereby promoting a good endurance of micro-organisms to the diluted environment as opposed to the unsupported system which is adversely affected by mixing [7].

In calcium alginate supported system, the substrate utilization showed a generally sharp decline from the first day the set-up was made. This is attributed to the protection of the microbial population by the membrane from the harsh environment. The adaptation of micro-organisms to the substrate was sequential due to the bit-wise permeation of substrates into the bead nucleus.

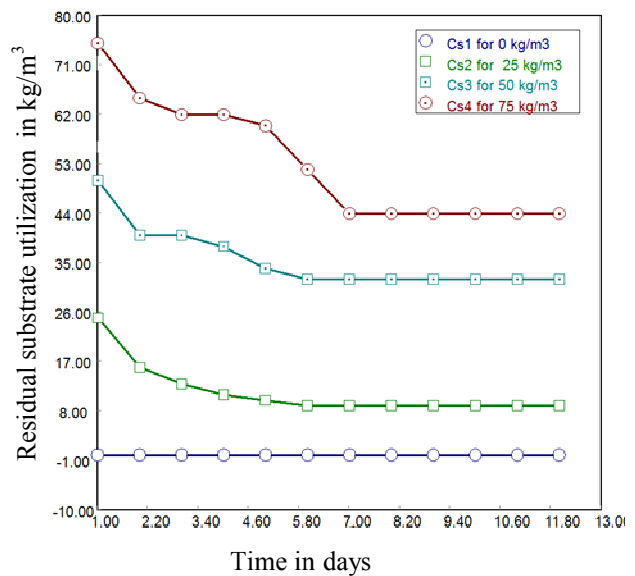

Fig.6 Kinetics of substrate reduction on calcium alginate supported system

The system also exhibited a discontinuous curve between day 2 and day 4 as shown by the figure 6. The dissolution of the alginate beads could have resulted into this phenomenon as it appeared in synchrony with exact times in which the bead dissolution was observed. There was also a big utilization of substrate in the system containing 75 kg/m<sup>3</sup> because of the same reasons discussed in section B

#### D. Kinetics of Oxygen Inhibition over Different Support Materials in a Batch System.

In the second set of experiments performed, the set-ups had a common initial organic loading of COD 50 kg/m<sup>3</sup> each and vortexed moderately for 10 minutes at intervals of 8 hours. Each system set was treated separately where the factors

tested were the immobilization regime of the system. In the case of unsupported system, the biochemical process was able to tolerate oxygen exposure levels for up to 30 minutes. Any exposures beyond the 30 minutes inhibited the system. This could be because of the thin boundary layer between the microbes and the injected air. The permeation of oxygen into the microbial cells was faster than in the other cases and therefore the system could be easily upset.

The system having biomass immobilized unto activated natural zeolite showed a more robust tolerance to oxygen inhibition. It tolerated air bubbling for periods upto 90 minutes. This behavior could be explained by consideration of the boundary layer and intra-particulate adsorption scenarios which shielded the microbes as explained in section B

Lastly, the system having immobilized biomass on calcium alginate gel was able to withstand oxygen exposure levels upto 60 minutes. The resilience of this system could have been due to the explanation earlier given in section C. The period of tolerance was lower than that of activated natural zeolite system, which gave the most robust, but doubles that of the unsupported system. The lesser value realized in the calcium alginate supported system also, could have been occasioned by the observed dissolution of the beads due to the presence of monovalent cations and phosphate buffers in the culture media used.

Therefore it can be concluded that, immobilization of the methanogenic consortium unto activated natural zeolite supports and calcium alginate beads increases the system tolerance to oxygen inhibition by more than two times that tolerated by free methanogenic consortia. This corroborates the data obtained by [9] where it was found that, free system showed almost irreversible loss of biological activity at exposure levels of 45 minutes whereas the methanogenic consortium immobilized unto poly(acrylonitrile-acrylamide) co-polymer support, regained its biological activity after 45 minutes of oxygen exposure.

#### E. Determination of the Optimal Organic Loading of the System

The output variables of concern were biogas produced per unit initial COD and the percentage reduced COD of the system. These output variables were each studied with respect to the initial COD and the optimal level was then determined.

#### DETERMINATION OF THE OPTIMAL ORGANIC LOADING BASED ON THE PRODUCT YIELD.

In all the three systems, the cumulative volume of biogas produced was evaluated and listed corresponding to respective initial organic loading of every system. The product yield was then evaluated and a presentation of the relationship between the product yield and the initial COD was computed and presented in figure 3.7.

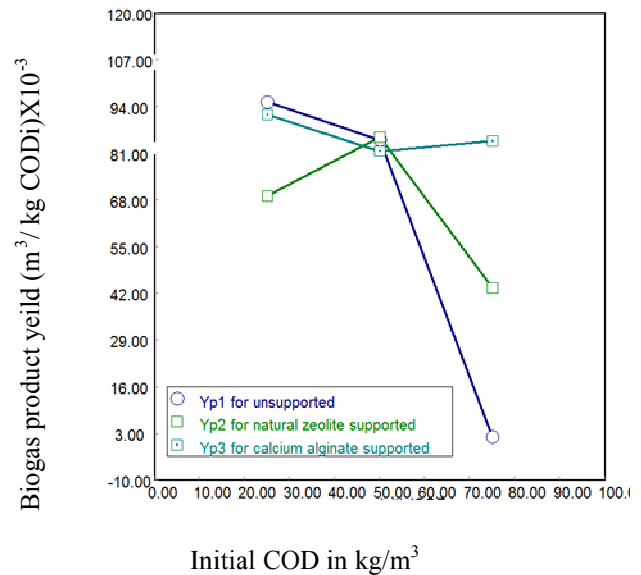

Fig. 7 Relationship between the biogas yield and initial organic loading

Since the focus of the research was to investigate a system that offered the highest organic stabilization and biogas at high organic loading, figure 3.7 shows that the system which had calcium alginate support gave the optimal biogas yield of  $84.5 \times 10^{-3} \text{ m}^3/\text{kg COD}_i$  at the marginal organic loading of  $75 \text{ kg/m}^3$ . This corresponded to a total COD reduction of  $33 \text{ kg/m}^3$

Although the calcium alginate registered the highest biogas yield, the beads dissolved on the second day due to the presence of the phosphates as buffer and excess of monovalent ions originating from the sodium hydroxide that was used to adjust the pH.

Therefore, based on the biogas yield, the calcium alginate supported system registered the optimal value at maximum organic loading.

#### DETERMINATION OF THE OPTIMAL ORGANIC LOADING BASED ON THE DEGREE OF WASTE WATER STABILIZATION.

In all the three systems, the residual COD of the system at both the start and the end of the run was evaluated and listed corresponding to respective initial organic loading of every



system. The percentage COD reduction was then evaluated and a presentation of the relationship between the percentage organic loading reduction and the initial COD was computed and presented in figure 3.8. In this case, Chemical Oxygen Demand was the quantity used as the inferential factor of the degree of stabilization of the organics.

Since the overall research goal was focused on the investigation of a system that could offer the highest organic stabilization at high organic loading, the analysis in the figure 3.8 were made so that optimal values of parameters could be established. From the analysis, the system containing biomass immobilized on activated natural zeolite support registered an effluent stabilization of 44% at the marginal organic loading of 75 kg/ m<sup>3</sup>. This corresponded to a total COD reduction of 33 kg/ m<sup>3</sup>

Although the natural zeolite registered the highest COD reduction, the beads in the calcium alginate supported system had dissolved due to the presence of the phosphates and excess of sodium ions. This dissolution also resulted into the addition of COD to the system since structurally, the calcium alginate gels are organic polymers. This system, by speculation, could have registered the highest COD reduction had the beads been stable. The calcium alginate system showed a general decline in the COD reduced until it reached the lowest value at 50 kg/m<sup>3</sup> then it again began to increase as the initial COD of the system was increased towards the marginal high. The small slumping behavior of the system might have been due to the liberation of more Ca<sup>2+</sup> which in turn increased the electrolytes into the solution and thereby causing osmotic pressure problems to the microbes upon the hydrolysis of the two uronic constituting the alginate polymer.

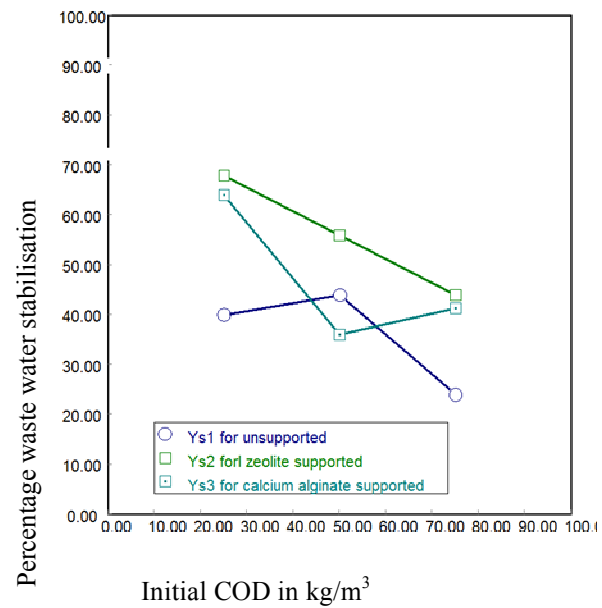

Fig.8 Relationship between the percentage waste water stabilisation and initial organic loading

Therefore, based on the organic stabilization, the activated natural zeolite supported system registered the highest value of 44% at maximum organic loading better than the other two systems.

#### IV. CONCLUSION AND RECOMMENDATION

##### A. Conclusions

From the results based on effluent stabilization, the system containing biomass immobilized on activated natural zeolite support registered the highest effluent stabilization of 44% at the marginal organic loading of 75 kg/ m<sup>3</sup>. This corresponded to a total COD reduction of 33 kg/ m<sup>3</sup>

Based on the product yield, the system which had calcium alginate support registered the highest biogas yield of  $84.5 \times 10^{-3} \text{ m}^3/\text{kg COD}_i$  at the marginal organic loading of 75 kg/ m<sup>3</sup>. However, in this system, the calcium alginate beads dissolved before the experiment came to conclusion.

Finally, in consideration of the system resilience to inhibitor seepage, the unsupported, the activated natural zeolite and the calcium alginate supported systems demonstrated sterile air bubbling tolerances for upto 30, 90 and 60 minutes respectively. The activated natural zeolite supported system showed the highest oxygen tolerance permeation than the other two systems. The unsupported system on the other hand is more susceptible to oxygen poisoning than the rest. Therefore, immobilization of the methanogenic consortia offers some protection to the microbes from oxygen poisoning.

### *B. Recommendation*

Although the natural zeolite registered the highest COD reduction, the beads in the calcium alginate supported system dissolved due to the presence of the phosphates and excess of sodium ions. Therefore, the true picture of how the system would have behaved if the beads hadn't dissolved need to be established. It is therefore recommended that further experiments that avoid the use of antagonistic agents like phosphates and sodium salts be set-up so as to give clear behavior.

### ACKNOWLEDGEMENT

We thank the National Council of Science and Technology for their financial support towards this project. Also, we are thanking the Department of Chemical and Process Engineering, Moi University for availing the equipments we used in the experiments involving this work.

### REFERENCES

- [1]. Mohana, Saraya. Chirayu Desai. Datta Madamwar. Biodegradation and decolourization of anaerobically treated distillery spent wash by a novel bacterial consortium. 2005, *Bioresource Technology*, pp. 333-339.
- [2]. Y. Satyawali, M. Balakrishnan, Wastewater treatment in molasses-based alcohol distilleries for COD and color removal: A review. *Journal of Environmental Management*, pp. 481-497, 2007
- [3]. Ye Chen, Jay J. Cheng, Kurt S. Creamer. Inhibition of anaerobic digestion process: A review. *Bioresource Technology* 99, pp. 4044-4064, 2007.
- [4]. Van Staikenburg, W. Anaerobic treatment of wastewater: state of the art, *Microbiology* 66, pp. 589-596, 1997
- [5]. Dahiya, Jagroop et al. Decolourisation of molasses wastewater by cells of *Pseudomonas Fluorescens* immobilised on porous cellulose carrier. *Bioresource Technology*, pp. 112-114, 2000.
- [6]. Lee, James M. *Biochemical Engineering*. New Jersey : Prentice Hall Inc, 1992.
- [7]. Inamdar, Syed Tanveer. *Biochemical Engineering, Principles and Concepts* 2nd Edition. New Delhi : Asoke K. Ghosh, PHI Learning Private Ltd, 2009.
- [8]. Asgari, Mohammad Javad. *Biogas Production Technology*, Applied Science Reports, pp. 57-60. 2013.
- [9] Lalov Ivo et al. Improvement of Biogas production from Vinasse via Covalently Immobilised Methanogens, 2001, *Biosource Technology*, 83-85.

# Comparing the Performance of Linksys and D-Link under LOS Conditions

Omae M. O, Ndungu E. N and Kibet P. L.

**Abstract-** The use of WIFI routers has currently had very high growth in the corporate and domestic applications. Because of this high demand, research need to be undertaken to understand the devices to be used to enable one make informed decision on which to select. The research looked into the performance of the routers in line of sight (LOS) of conditions. This was done by setting up the routers and a mobile phone as transmitters and a receiver respectively. The routers used in the experiment were stationary while the mobile phone was placed at increments of 1 metre distance. From the results it was found out that the D-link router performed better than the linksys. This is supported by the results obtained from the data collected and analyzed.

Keywords: D-link, Linksys, WIFI, LOS

## I. INTRODUCTION

The use of wireless telecommunication technologies is a field that is currently growing at tremendous strides more so the wireless local area networks (WLANs) and mobile phone besides others like radar, satellite, radio and TV [1]. These technologies have been researched on since the fathers of the same like Maxwell, Hertz and Macon worked on the basics in the late 19th and early 20th century. Currently the wireless technologies have found their way into most households in terms of myriad applications. The WLANs more so the WIFI technology is a hit for most wireless applications.

### A. Statement of the problem

Wireless telecommunication technologies are currently becoming a very important concept in our lives. Many scientists have done various studies in regard to this technology and continue doing the same to ensure quality of service to the ever growing number of users. In view of this the idea of also adding to the progressing research in this field was conceived by performing an experiment to evaluate the performance of some of the most commonly used routers specifically D-link and Cisco Linksys.

### B. Research objectives

1. To analyze how signal strength varies with increase in distance in LOS.

Omae M. O, Ndungu E. N, Kibet P. L. School of Electrical, Electronic and Information Engineering, Department of Telecommunication & Information Engineering, JKUAT (phone: +2540722805012; +2540721366349, +2540724833749 fax: +2546752711; e-mail: m\_oteri@yahoo.com, ndunguen@yahoo.com, kibetlp@yahoo.com).

2. To analyze the effect of distance on power received from two routers
3. To compare the signal power received at similar distances from two routers
4. To compare the actual values of power received from the two routers to the theoretical values

## II. LITERATURE REVIEW

### A. Linksys Router

The Linksys router has four 10/100 Fast Ethernet ports on the rear panel, antennas fixed to the chassis operating at 2.4 GHz to 2.4835GHz and 802.11n standard. Its theoretical throughput is up to 300 Mbps with this router [2].

### B. D-link Router

The DIR-605L also has four 10/100 Fast Ethernet ports on the rear panel, two external 5dBi antennas fixed to the chassis operating at 2.4 GHz to 2.4835GHz and 802.11n standard. Theoretical throughput is up to 300 Mbps, Internal components include Realtek's RTL8196C chip. The chassis also features reset and WPS buttons. The device is small, with a plastic, black housing. There are seven LEDs on the top representing power, WAN activity, wireless status, and LAN port activity [2]. The cost of the two is the same in the Kenyan market.

### C. Free space path loss

Free space path loss (FSPL) is the loss in signal strength that occurs when an electromagnetic wave travels over a line of sight (LOS) path in free space. In such a circumstance, there are no obstacles that might cause the signal to be reflected, refracted or that might cause additional attenuation. [3]

When calculating thus, factors relating to the transmitter power, antenna gains or the receiver sensitivity levels are not considered and only the loss along the path itself is considered.

As a signal moves away from the transmitter, it keeps spreading out in the form of a sphere increasing the sphere's surface area with increase in distance thus, the intensity of the signal decreases. It can be deduced that the signal decreases in a manner that is inversely proportional to the square of the distance from the source of the radio signal in free space.

Losses are experienced in radiowave communication links as the signal is sent from the source to the destination. One type of such losses is path losses. These occur due to effects along the transmission media. Under path losses we have free space losses among others [4]. These are highly affected by variation of distance and frequency.

The received power at the destination in dB is given by:-

$$P_R = P_t G_t G_R / \left[ (4\pi d/\lambda)^2 \right] \dots \dots \dots (1)$$

$$P_R = P_t + G_t + G_R - FSL \text{ dB} \dots \dots \dots (2)$$

$P_R$  is received power  
 $P_t$  is the transmitted power  
 $G_t$  is the transmitter gain  
 $G_R$  is receiver gain  
 This is referred to as Friis equation which is the link equation.  
 Free space losses (FSL) is given by:-  
 $FSL = 32.44 + 20 \log d + 20 \log f \dots \dots \dots (3)$

Where;  
 FSL= free space losses in dB  
 d= distance between the source and destination in kms  
 f= frequency

In our experiment, the apparatus used have the following specifications:

**Mobile Phone Receiver**

$$G(r) = +4\text{dB}$$

**Cisco LinksysE900 router (Transmitter)**

$$P(t) = +14\text{dBm}; G(t) = +4\text{dBi}$$

Therefore,  $P(\text{Cisco}) = 14 + 4 + 4 = +22\text{dB}$ .

**D-Link DIR 605L router (Transmitter)**

$$P(t) = +15\text{dBm}; G(t) = +4\text{dBi}$$

Therefore,  $P(\text{D-Link}) = 15 + 4 + 4 = +23\text{dB}$ .

The fundamental design of and plan of indoor wireless network depends on the measurement and analysis of the WI-FI signal. Distance is one of the major contributors of the attenuation of the radio signal propagation known as the path loss [5]. The signal received by the user reduces in power with the distance it traverses following an inverse square law. For an ideal condition the power of the signal is given by

$$P_R = P_t + G_t + G_R - FSL \text{ in dB}$$

Where  $P_R$  is the power transmitted  
 $P_t$  is power of the router  
 $G_t$  is the gain of the router  
 $G_R$  is the antennae gain for the mobile device/laptop

FSL is given by  $32.44 + 20 \log d + 20 \log f$  where d is the distance in km and f is the frequency in MHz [3].

III. RESEARCH METHODOLOGY

A. Practical Measurement of  $P_R$

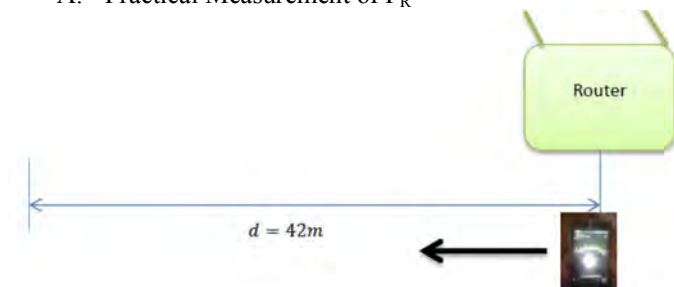

Figure 1: Diagram of the experimental Set up



Figure 2: Image of the experimental Set up

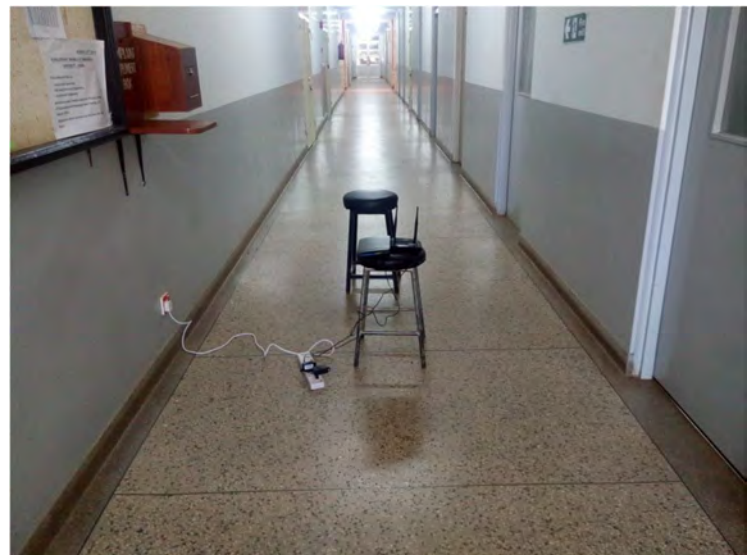

Figure 3: Image for the experimental Set up in a corridor

The steps for carrying out the experiment are as follows;

- i. A tape measure was used to measure a distance of 42m that was subdivided into 42 points each 1m apart.
- ii. The Techno R7 mobile device was moved metre by metre away for the D-link router and took the readings for every 1m from the router in table 1.
- iii. Procedures (i) and (ii) were repeated for the Cisco linksys router and the data recorded as well in table 2.

B. Data analysis

For this study, the content analysis technique was employed to analyze the data. Matlab graphical representation techniques were used to analyze quantitative data. The full report on the key findings of this study by the researcher is presented in section below.

#### IV. FINDINGS AND DISCUSSIONS

##### A. Results

For the D-link router, the results were as shown in the table below

TABLE I: D-LINK RECEIVED POWER MEASUREMENTS

Distance (m)	$P_R$ Value (dBm)
1	-38
2	-42
3	-47
4	-44
5	-48
6	-52
7	-51
8	-48
9	-53
10	-49
11	-58
12	-53
13	-57
14	-54
15	-49
16	-54
17	-53
18	-53
19	-55
20	-54
21	-62
22	-55
23	-56
24	-54
25	-52
26	-55
27	-56
28	-52
29	-55
30	-56
31	-57
32	-58
33	-53
34	-48
35	-51
36	-50
37	-51
38	-53
39	-52
40	-54
41	-54
42	-52

For the Cisco router (XYZ), the results were as in the table below

TABLE II: LINKSYS RECEIVED POWER MEASUREMENTS

Distance (m)	$P_R$ Value (dBm)
1	-39
2	-42
3	-45
4	-48
5	-50
6	-53
7	-54
8	-52
9	-52
10	-54
11	-60
12	-59
13	-64
14	-58
15	-53
16	-59
17	-59
18	-57
19	-62
20	-61
21	-64
22	-62
23	-64
24	-63
25	-60
26	-61
27	-59
28	-58
29	-60
30	-60
31	-59
32	-60
33	-57
34	-57
35	-60
36	-57
37	-60
38	-59
39	-60
40	-60
41	-60
42	-57

Based on the measurement Matlab analysis, the following graphs were generated.

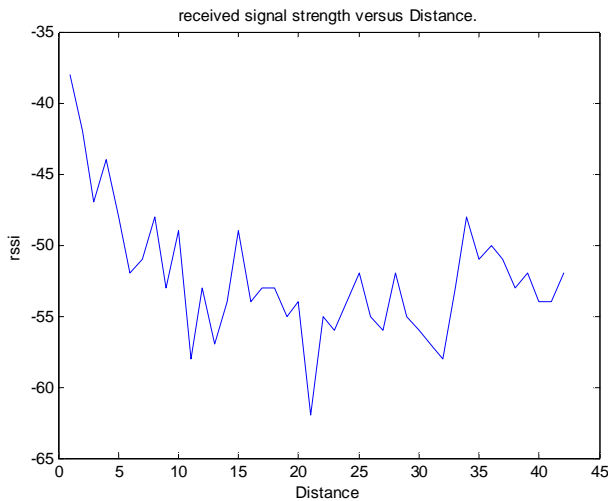

Figure 4: D-link received signal variation with distance

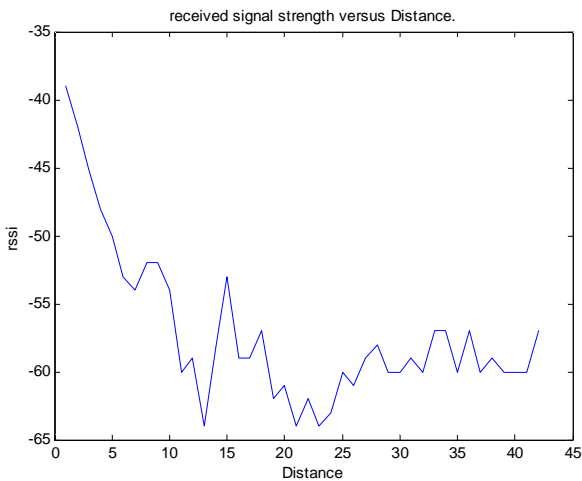

Figure 5: Linksys received signal variation with distance

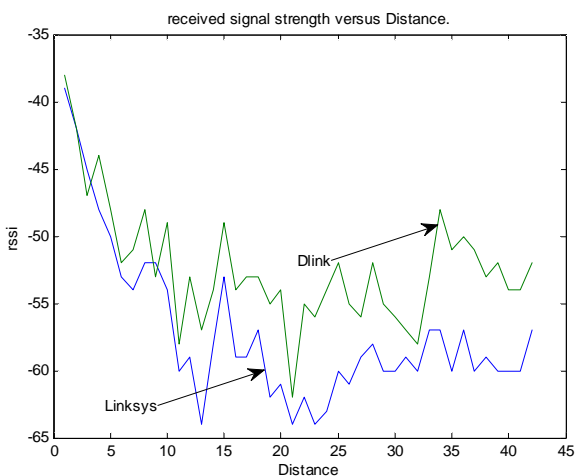

Figure 6: D-link and Linksys received signal variation with distance

The graphs generated using the values obtained during the experiment are comparable as shown above. The signal strength is expected to reduce gradually due to the increase in distance between the transmitter and the receiver. However, from the practical analysis, it was observed that the reduction in signal strength is not smooth/gradual as expected. This could be due to several factors for instance the presence of some obstacles like people and walls. The other reason could be due to the random nature of radiowave signals. The nature of the obstacles determined whether the signal would be affected constructively or destructively. Some obstacles would absorb the signal; others reflect, diffract, scatter or cause it to fade.

According to the combined graph we note that the signal strength for Linksys router is less than that of D-link router indicating that in terms of received signal strength D-link performs slightly better than Cisco Linksys. The main reason could be due to the use of the external antennas which have a better gain than those used with Cisco.

## V. SUMMARY, CONCLUSIONS AND RECOMMENDATIONS

### A. Conclusion

From experimentation and calculations performed as a result thereof, it can be stated that the power of a signal transmitted in free space decreases with an increase in distance from the source.

It can also be concluded from the experimentation that the Cisco – Linksys E900 router is no match for the D-link – DIR 605L router as the D-link – DIR 605L router transmits higher strength signals.

### B. Limitations of the study

The major limitation of the study was random behavior of the received signal resulting to unsteady measurements.

### C. Areas of further study

Future research should include the overall performance of the two routers including other performance parameters like security and speeds.

## REFERENCES:

- [1] Chapre, Yogita, et al. "Received signal strength indicator and its analysis in a typical WLAN system (short paper)." Local Computer Networks (LCN), 2013 IEEE 38th Conference on. IEEE, 2013.
- [2] <http://www.pcmag.com/article2/0,2817,2404391,00.asp>
- [3] Kennedy G & Davis B. (1999), Electronic Communication Systems, Tata McGraw Hill, 4th Ed.
- [4] Gordon G. D. & Morgan W. L (1993), Principles of Communication Satellites, John Wiley & Sons.
- [5] Turner, Daniel, Stefan Savage, and Alex C. Snoeren. "On the empirical performance of self-calibrating wifi location systems." Local Computer Networks (LCN), 2011 IEEE 36th Conference on. IEEE, 2011.

# Comparison of Wi-Fi Signal Indoor LOS Coverage and Propagation through Walls

Omae M. O, Ndungu E. N and Kibet P. L.

**Abstract-** Wireless local area networks (WLANS) are becoming very important in our daily communications applications. This has necessitated their study to improve on the quality of service (QoS). This study is aimed at comparing the Wi-Fi signal propagation along a corridor and through walls as obstacles. It was found that the signal was highly attenuated when passing through the walls as opposed to along the corridor. The study was undertaken using Wi-Fi router and a mobile phone as the receiver.

**Key words;** Wi-Fi, QoS, WLANS

## I. INTRODUCTION

Wi-Fi networks form one of the largest market segments of wireless networks. Coverage in outdoor environments is limited both by physical obstacles and structural barriers, while in built environments, the main obstacles are walls. What is common for both is interference in the wireless spectrum. The most commonly used ISM bands for Wi-Fi networks are at 2.4 GHz and 5 GHz, and the signals at such high frequencies do not easily pass through the obstacles. To increase connectivity and extend coverage, Wi-Fi networks use limited transmission powers, typically up to 100 mW. This gives connectivity of a few tens of meters, even through walls. At the same time, line-of-sight connectivity may reach significantly greater distances, causing far away nodes to interfere in very unusual patterns. This experiment investigated the coverage of Wi-Fi networks through walls.

### A. Statement of the problem

Wireless telecommunication technologies are currently becoming a very important concept in our lives. Many scientists have done various studies in regard to this technology and continue doing the same to ensure quality of service to the ever growing number of users. In view of this the idea of also adding to the progressing research in this field was conceived by performing an experiment to evaluate the performance of some of the most commonly used routers specifically D-link and Cisco Linksys.

### B. Research objectives

Main objective;

Omae M. O, Ndungu E. N, Kibet P. L. School of Electrical, Electronic and Information Engineering, Department of Telecommunication & Information Engineering, JKUAT (phone: +2540722805012; +2540721366349, +2540724833749 fax: +25467527111; e-mail: m\_oteri@yahoo.com, ndunguen@yahoo.com, kibetlp@yahoo.com).

To compare signal propagation along a corridor and through walls.

Specific objectives

1. To analyze how signal strength varies with increase in distance in LOS.
2. To analyze how signal strength varies with propagation through walls.
3. To compare the two above.

## II. LITERATURE REVIEW

### A. Introduction

Wireless networking works by sending radio transmissions on specific frequencies where listening devices can receive them. The necessary radio transmitters and receivers are built into Wi-Fi enabled equipment like routers, laptops and phones. Antennas are also key components of these radio communication systems, picking up incoming signals or radiating outgoing Wi-Fi signals. Some Wi-Fi antennas, particularly on routers, may be mounted externally while others are embedded inside the device's hardware enclosure [1].

Cisco-Linksys router's antenna and that of the phone used are embedded inside while the D-Link routers have two external antennas.

### Antenna Power Gain

The connection range of a Wi-Fi device depends greatly on its antenna's power gain. A numeric quantity measured in relative decibels (dB), gain represents the maximum effectiveness of an antenna compared to a standard reference antenna. Industry manufacturers use one of two different standards when quoting gain measures for radio antennas:

dBi - decibels relative to an isotropic reference antenna

dBd - decibels relative to a dipole reference antenna

Most Wi-Fi antennas have dBi as their standard measure rather than dBd. Higher values of gain indicate an antenna capable of working at higher levels of power, which usually results in greater range.

Wireless signal strength is measured in dBm (the power ratio in decibels of the measured power referenced to one milliwatt). The WiFi Analysis tools used in the experiments display the signal strength in dBm [1].

### Omnidirectional Wi-Fi Antennas

Some radio antennas are designed to work with signals in any direction. These omnidirectional antennas are commonly used

on Wi-Fi routers and mobile adapters as such devices must support connections from multiple directions.

**Isotropic Antenna**

An isotropic antenna is defined as "a hypothetical lossless antenna having equal radiation in all directions." Clearly, an isotropic antenna is a fictitious entity, since even the simplest antenna has some degree of directivity. Although hypothetical and not physically realizable, an isotropic radiator is taken as a reference for expressing the directional properties of actual antennas.

**Outdoor Wireless RF Channels**

There are several causes of signal corruption in an outdoor wireless channel. The primary causes are signal attenuation due to distance, obstacles like foliage and multipath propagation.

**Indoor Wireless RF Channels**

There are several causes of signal corruption in an indoor wireless channel. The primary causes are signal attenuation due to distance, obstacles like walls, furniture, people and multipath propagation.

**B. Effect of distance**

Signal attenuation over distance is observed when the mean received signal power is attenuated as a function of the distance from the transmitter. The most common form of this is often called free space loss and is due to the signal power being spread out over the surface area of an increasing sphere as the receiver moves farther from the transmitter.

In addition to free space loss effects, the signal experiences decay due to ground wave loss although this typically only comes into play for very large distances (on the order of kilometers). For outdoor propagation this mechanism is important thus needs to be investigated [2].

**C. Multipath Propagation**

Multipath results from the fact that the propagation channel consists of several obstacles and reflectors. Thus, the received signal arrives as an unpredictable set of reflections and/or direct waves each with its own degree of attenuation and delay. The delay spread is a parameter commonly used to quantify multipath effects. Multipath leads to variations in the received signal strength over frequency and antenna location.

**D. Rate of fading**

Time variation of the channel occurs if the communicating device (antenna) and components of its environment are in motion. Closely related to Doppler shifting, time variation in conjunction with multipath transmission leads to variation of the instantaneous received signal strength about the mean power level as the receiver moves over distances on the order of less than a single carrier wavelength.

The degree of time variation in an outdoor system is much more than that of an indoor system. One manifestation of time variation is as spreading in the frequency domain (Doppler

spreading). The frequency in our case varied from 2412 to 2467 MHz.

**E. Free space path loss**

Free space path loss (FSPL) is the loss in signal strength that occurs when an electromagnetic wave travels over a line of sight (LOS) path in free space. In such a circumstance, there are no obstacles that might cause the signal to be reflected, refracted or that might cause additional attenuation. [3]

When calculating thus, factors relating to the transmitter power, antenna gains or the receiver sensitivity levels are not considered and only the loss along the path itself is considered.

As a signal moves away from the transmitter, it keeps spreading out in the form of a sphere increasing the sphere's surface area with increase in distance thus, the intensity of the signal decreases. It can be deduced that the signal decreases in a manner that is inversely proportional to the square of the distance from the source of the radio signal in free space.

Losses are experienced in radiowave communication links as the signal is sent from the source to the destination. One type of such losses is path losses. These occur due to effects along the transmission media. Under path losses we have free space losses among others [4]. These are highly affected by variation of distance and frequency.

The received power at the destination in dB is given by:-

$$P_r = P_t + G_t + G_r - FSL \tag{1}$$

$$P_r = P_t \text{ dB} + G_t \text{ dB} + G_r \text{ dB} - FSL \text{ dB} \tag{2}$$

$P_r$  is received power

$P_t$  is the transmitted power

$G_t$  is the transmitter gain

$G_r$  is receiver gain

This is referred to as Friis equation which is the link equation. Most RF comparisons and measurements are performed in decibels. This gives an easy and consistent method to compare the signal levels present at various points. Accordingly it is very convenient to express the free space path loss formula, FSPL, in terms of decibels. It is easy to take the basic free space path loss equation and manipulate into a form that can be expressed in a logarithmic format.

Free space losses (FSL) is given by:-

$$FSL = 32.44 + 20 \log d + 20 \log f \tag{3}$$

Where;

FSL= free space losses in dB

d= distance between the source and destination in kms

f= frequency

In our experiment, the apparatus used have the following specifications:

**Mobile Phone Receiver**

$$G(r) = +4\text{dB}$$

**D-Link DIR 605L router (Transmitter)**

$$P(t) = +15\text{dBm}; G(t) = +4\text{dB}$$



Therefore,  $P(D\text{-Link}) = 15 + 4 + 4 = +23\text{dB}$ .

The fundamental design of and plan of indoor wireless network depends on the measurement and analysis of the Wi-Fi signal. Distance is one of the major contributors of the attenuation of the radio signal propagation known as the path loss [5]. The signal received by the user reduces in power with the distance it traverses following an inverse square law. For an ideal condition the power of the signal is given by

Where  $P_R$  is the power transmitted  
 $P_t$  is power of the router  
 $G_t$  is the gain of the router

$G_R$  is the antennae gain for the mobile device/laptop  
FSL is given by  $32.44 - 20 \log_{10} d - 20 \log_{10} f$  where  $d$  is the distance in km and  $f$  is the frequency in MHz [6].

### III. RESEARCH METHODOLOGY

#### A. Practical Measurement of $P_R$

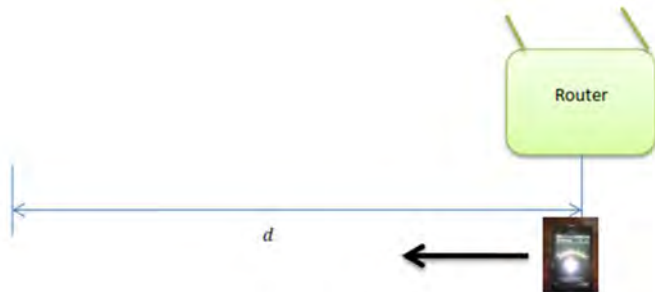

Figure 1: Diagram of the experimental Set up



Figure 2: Image for the experimental Set up



Figure 3: Image for the experimental Set up in a corridor

The steps for carrying out the experiment are as follows;

- i. A tape measure was used to measure a distance of 42m that was subdivided into 42 points each 1m apart.
- ii. The Techno R7 mobile device was moved metre by metre for the D-link router and took the readings for every 1m from the router in table 1.
- iii. Procedures (i) and (ii) were repeated for the indoor and the data recorded as well in table 2.

#### B. Data analysis

For this study, the content analysis technique was employed to analyze the data. Matlab graphical representation techniques were used to analyze quantitative data. The full analysis on the key findings of this study is presented in section below.

IV. FINDINGS AND DISCUSSIONS

A. Results

For the LOS case, the results were as shown in the table below;

TABLE I: D-LINK RECEIVED POWER MEASUREMENTS

Distance (m)	P <sub>R</sub> Value (dBm)
1	-38
2	-42
3	-47
4	-44
5	-48
6	-52
7	-51
8	-48
9	-53
10	-49
11	-58
12	-53
13	-57
14	-54
15	-49
16	-54
17	-53
18	-53
19	-55
20	-54
21	-62
22	-55
23	-56
24	-54
25	-52
26	-55
27	-56
28	-52
29	-55
30	-56
31	-57
32	-58
33	-53
34	-48
35	-51
36	-50
37	-51
38	-53
39	-52
40	-54
41	-54
42	-52

For indoor, the results were as in the table below;

TABLE II: LINKSYS RECEIVED POWER MEASUREMENTS

Distance (m)	P <sub>R</sub> Value (dBm)
1	-44
2	-41
2.4	-47
2.6	-56
3.6	-52
4.6	-57
5.3	-57
5.5	-67
8.2	-67
8.4	-75
10.5	-88

Based on the measurement Matlab analysis, the following graphs were generated.

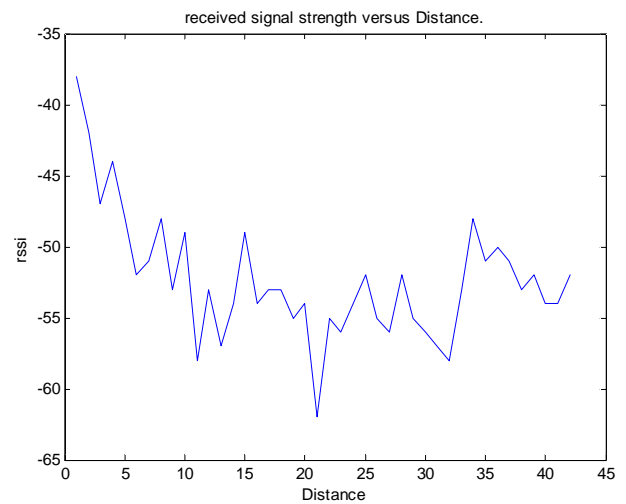

Figure 4: LOS received signal variation with distance

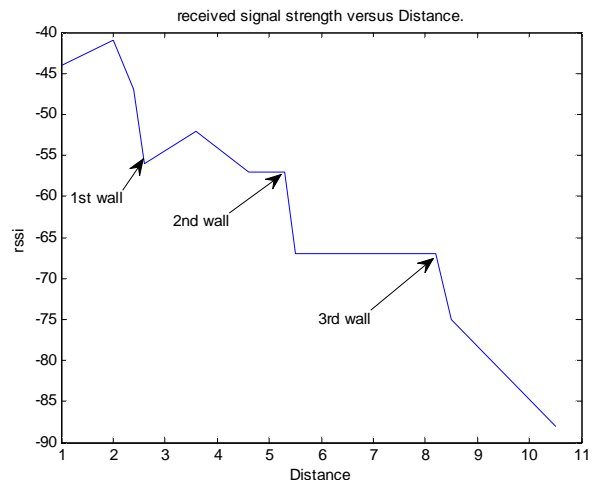

Figure 5: Indoor received signal variation with distance

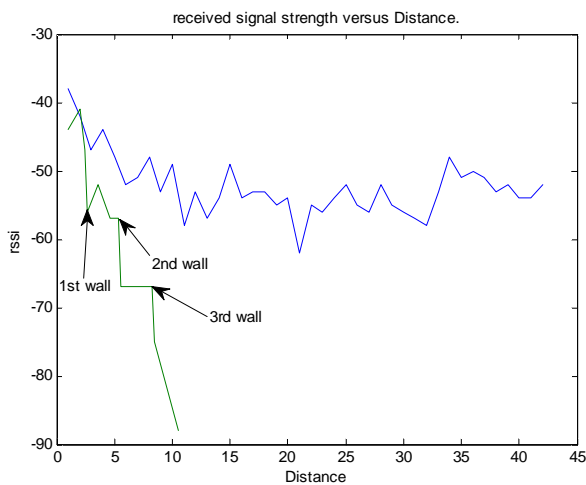

Figure 6: LOS and indoor received signal variation with distance

The graphs generated using the values obtained during the experiment are as shown above. The signal strength reduces gradually as expected due to the increase in distance between the transmitter and the receiver. For LOS propagation, it is seen that for each router, at the same measurement location, the time graphs show a variation in signal strength. This is due to variations in the channel conditions. The channel's transfer characteristics may vary due to movements of the transmitter, receiver or other objects like people and cars in the outdoor environment. The transmitted signal may reach the receiver through multiple reflected paths. These reflected signals may add up to strengthen each other or they may add up to cancel each other. Also, presence of objects in the path between the transmitter and the receiver also reduces the signal power arriving at the receiver. All this manifest themselves in the fluctuations in the power levels of different received signals.

While measuring signal propagation through walls, it is seen that the strength of the signals reduce drastically as they penetrate through the walls. In fact, the signal could only pass through three of the walls in the set up environment, and the signal was lost at a quarter of the distance covered in the case of LOS propagation.

Therefore, even though the Wi-Fi signals can pass through walls, they are better suited to be used in areas with preferably no obstacles between the access point and the receiver.

## V. CONCLUSIONS AND RECOMMENDATIONS

### A. Conclusion

From experimentation and calculations performed as a result thereof, it can be stated that the power of a signal transmitted in free space decreases with increase in distance from the source.

It can also be concluded from the experiment that the signal through walls was attenuated to the extent that very low signal is received after the third wall.

### B. Limitations of the study

The major limitation of the study was random behavior of the received signal and lack of measurements of the walls in the building under study.

### C. Areas of further study

Future research should include the study of other routers in the same environments.

## REFERENCES

- [1] Scholz, Dipl Ing Peter, and K. G. KATHREIN-Werke. "Basic Antenna Principles for Mobile Communications." Polarization 45.45 (2000): 12.
- [2] Sohail, Ahsan, Zeeshan Ahmad, and Ifikhar Ali. "ANALYSIS AND MEASUREMENT OF WI-FI SIGNALS IN INDOOR ENVIRONMENT 1." (2013).
- [3] Kennedy G & Davis B. (1999), Electronic Communication Systems, Tata McGraw Hill, 4th Ed.
- [4] Gordon G. D. & Morgan W. L (1993), Principles of Communication Satellites, John Wiley & Sons.
- [5] Turner, Daniel, Stefan Savage, and Alex C. Snoeren. "On the empirical performance of self-calibrating wifi location systems." Local Computer Networks (LCN), 2011 IEEE 36th Conference on. IEEE, 2011.
- [6] Mongia, Puneet Kumar, and B. J. Singh. "Planning and Optimization of Wireless LANs through Field Measurements." arXiv preprint arXiv:1309.1184 (2013).

# The distribution and reproductive patterns of the *Epinephelus* genera groupers off Kenyan South Coast inshore marine waters

Ogongo B. Ochieng and Orembo B. Okeyo

**Abstract**— The distribution and reproductive patterns of the *Epinephelus* genera groupers was investigated from December, 2013 to July, 2014 at Msambweni, Shimoni, and Vanga within the Kenyan south coast inshore marine waters. Data was obtained from both experimental underwater visual surveys and artisanal fishery landings for species composition, abundance, proportions, and gonadal maturity stage determinations. The results showed that 30 *Epinephelus* genus grouper species of near similar proportions existed within the Kenyan south coast inshore marine waters. The genus is dominated by *Epinephelus fasciatus* which accounts for 13.5% of the total landings. Eleven (11) species; *E. fasciatus*, *E. malabaricus*, *E. longispinis*, *E. chlorostigma*, *E. coeruleopunctatus*, *E. multinotatus*, *E. merra*, *E. melanostigma*, *E. tukula*, *E. fuscoguttatus*, and *E. tauvina* had dominantly wide coastal distribution patterns. Conversely, *E. flavocaeruleus*, *E. chabaudi*, *E. (l)<sup>1</sup>socialis*, *E. undulosus*, and *E. morrhua* were commonly distributed only to Msambweni. *Epinephelus polyphekadion* in Shimoni and the single specimen of *Epinephelus acanthistus* was observed only in Vanga. All maturity stage fishes involving (18) of the total (30) landed species were also encountered only in June and July indicating that peak reproductive patterns for most species fall within this southeast monsoon (SEM) season.

**Keywords**— Distribution, *Epinephelus* genera, Kenyan south coast fisheries, Reproduction patterns.

## I. INTRODUCTION

Aquatic resources are being increasingly exploited globally for food, ornamental display, curios and medicine making valuable marine food fishes such as *Epinephelus* genera groupers exploitation to continue playing important economic and food security roles [1]-[3].

The species belong to the Epinephelinae subfamily within the Serranidae family in the perciformes order. Most are highly sedentary K-strategist slow growers with delayed reproductions, reduced spawnings, long life-spans and large sizes (>100 cm total length, TL) that make them vulnerable to

over-exploitation. Many also form spawning aggregations that are (l)<sup>2</sup>predictable in space and time making them easy targets to even small scale spear fishers [4]-[6]. These small scale multi-gear species fishes play important economic roles within the tropical and sub-tropical coral reef fisheries and heavy fishing pressure affects their population dynamics globally [7]-[11]. Consequently, their sustainable management can only be achieved by availing and using their basic life history parameters, various population dynamics, and stock assessment aspects research information [12], [13] as they are widely distributed in Indo-west Pacific, Red Sea, Philippines, Southern Japan, Hawaii waters, and in Eastern Africa where they are locally known as “Tewa” (Rock cods) [14], [15].

These *Epinephelus* genera groupers are typically stout with compressed bodies and brown spots or blotches in addition to having slightly elongate and very large mouths with protruding lower jaws that make them to be slow swimmers (Figure 1). They are mostly solitary predatory fishes that occur on continental or insular shelves on coral reefs and rocky substrates in areas with less than 200 m depth. Some are quite large, with lengths of over a metre and weights of even 100 kg. They mainly feed on invertebrates (crustaceans and cephalopods) and fishes while those with long numerous gill rakers feed on zooplankton.



Fig 1: *Epinephelus* genera groupers (Photo taken during sampling).

B. Ogongo, Department of Natural Product and Post-Harvest Technology, Coastal and Marine Fisheries Programme, KMFRI HQ, P.O.BOX 81651-80100, Mombasa-Kenya (Office Telephone Numbers: +254208021560 / 1; Mobile: +254733852287; Fax: +254202353226). [bogongo@yahoo.co.uk](mailto:bogongo@yahoo.co.uk) / [bogongo@kmfri.co.ke](mailto:bogongo@kmfri.co.ke)

B. Okeyo, Fisheries Taxonomy Department, Coastal and Marine Fisheries Programme, KMFRI HQ, P.O.BOX 81651-80100, Mombasa-Kenya

Although most species reproduction is yet to be studied, those already studied are protogynous hermaphroditic and have sequential female to male reproductive development change [16]. Therefore, they mature first as females and after one or more spawning, change sex and spawn as males when growing older; or when in populations with very low male: female sex ratios; or when in large spawning aggregations with male: female sex ratios of less than 1:1 [17]. Generally, most attain sexual maturity within 2–6 years and exhibit aggregation spawning behaviors including sharing of the spawning sites [18]. However, some larger species like *Epinephelus fuscoguttatus*, takes up to even 9 years to reach sexual maturity. Such reproductive biology and distribution pattern studies of the *Epinephelus* genera groupers off Kenyan coastal waters are scanty. References [19] and [20] remain among the few who have provided some biological literature on the spawning seasonality of *Epinephelus fuscoguttatus* and the groupers lunar reproductive activities within the East African region. The distribution and reproductive patterns of these key lagoon reef fishes therefore remains largely unknown despite being exploited by over 8000 Kenyan artisanal fishermen [21].

Therefore, taking into consideration that some 18 reef fish species including *Epinephelus fuscoguttatus* Forsskål, 1775 have been suspected of forming spawning aggregations along the Kenyan continental shelf [11], [22] and the absence of such *Epinephelus* genera groupers distribution and reproductive patterns information; the study aimed at determining the species distribution and reproductive patterns off Kenyan south coast marine waters for future management, restoration, and conservation implications..

## II. MATERIALS AND METHODS

### A. The Study Sites

The study was conducted within the inshore small-scale marine fishing areas of Msambweni (S 03°65'8", E 038°48'8"); Shimoni (S 04°44'54.2", E 039°21'58.8"); and Vanga (S 05°14'4", E 039°38'1") in south coast of Kenya. Msambweni fishing village lies about 70 km south of Mombasa city and currently experiences gradual urbanization. Shimoni with part of its fishing grounds having been hived from the fishing villages of Mpunguti and Mipwa on the mainland, Mwamba Mkuu in the adjacent Wasini Island and gazetted as a marine protected area (Kisite-Mpunguti Marine National Park and Reserve) is a major tourist attraction in south coast of Kenya encompassing the Pemba channel. Vanga fishing grounds and village is situated on the southern tip of Kenya-Tanzanian border (Fig. 2).

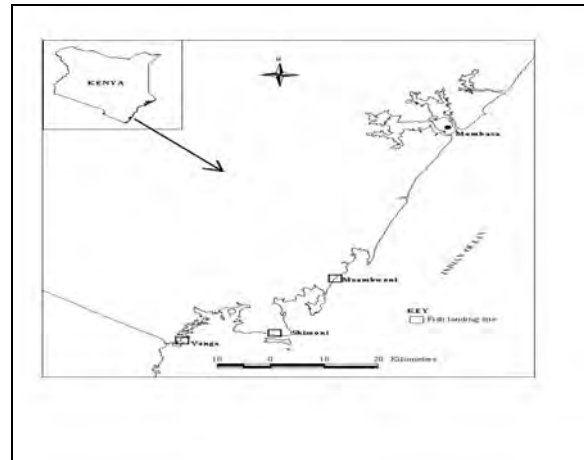

Fig. 2: The study sites map of Vanga, Shimoni, and Msambweni (Adopted from Agembe, 2009).

The sites were selected due to the existence of previous grouper studies undertaken from there; high grouper fishers and fisheries activity coefficient within Kenyan south coast; and lastly, for being the most pristine and sheltered reefs on the Kenyan coast making them key grouper fishing areas according to [23].

### B. Data Collection

Monthly field sampling and laboratory work involving inspection of the landed and visually observed *Epinephelus* serranids was conducted from December, 2013 to July, 2014. Data was obtained from both the small-scale fisheries landings and underwater visual surveys from the site's inshore waters where longitudinal swim surveys were carried out for three consecutive days in each sampling site for the collection of visual survey data.

A long-swim transect method protocol adopted from [24] involving surveying of transect lengths was developed and employed for the longitudinal swim surveys. Here, timed, unidirectional 100 metres transect belt underwater visual survey transect swims in depths of 2-15 metres of water was undertaken at each study site. Multiple transects surveyed within the same study site were separated by tens of metres and the *Epinephelus* serranid counts undertaken by a diving swimming observer at the species-level of resolution for abundance analysis. The transect lengths and swim-speed of 30 m<sup>2</sup> per minute were regularly checked and re-checked at the start of each sampling using GPS readings. The protocol involved detailed searches of buoy marked transect length substrata with slow timed swims of 45 minutes duration and fixed average search speed of 30 m<sup>2</sup> per minute. An estimated 5 metres transect width band was searched for cryptic and roving *Epinephelus* serranids due to their flighty

nature. Observations of the larger sized mobile *Epinephelus* serranids were made over a 10 metres estimated width band on either side of the central swim line. Each transect portion was viewed only once for each target species, and all encountered species individuals of 6 cm Total Length (TL) or greater, estimated using wooden fish models from a distance of 2 metres earlier compared with measured lengths; identified to species-level by the same observer, counted and data recorded onto a prepared water proof data slate to ensure consistency.

Landed *Epinephelus* serranids were also purchased from the small-scale grouper fishery operators at the landing sites for abundance, length, weight, and gonad maturity staging analysis. The landings were sorted and identified to species level using keys and guides from [25], [15], and [26]. Each groupers' total length was measured to the nearest 0.1 cm using a vernier calliper and also weighed to the nearest 0.01g on a top loading Salter digital balance model 2010 for small fishes (< 2.0 kg), or on a hanging Salter balance model 235 (100kg by 100g) for bigger individuals.

Each specimen was then dissected, sexed, and assigned a gonadal maturity stage based on macroscopic examination of the gonad following the scheme for *Epinephelus polyphkaidon* Bleeker, 1849 grouper described by [18]. Additional features used in staging as key indicators of prior spawning as illustrated by [27] included gonad vascularisation and gonad walls' relative thickness. The ovaries and testes were then classified into developmental stages with adaptations from [28] and [29] and the obtained reproductive information matched with fishing season.

### C. Gonad processing and analysis

Each individual's gonads were removed and reserved in 10% phosphate buffered formalin, or immediately frozen whole for processing back in the laboratory. At the laboratory, each gonad pair was thawed, dried of excess fixative, and their weights measured to the nearest 0.01 g. Where only one gonad lobe was available due to damage during processing, the gonad weight was estimated by multiplying the mass of the single complete lobe by two considering that the lobes are always equal in size for groupers as observed and recorded by [29]. They were then classified into developmental stages with adaptations from [28] and [29] (Table 1).

TABLE I  
MACROSCOPIC CRITERIA USED IN THE DETERMINATION OF MATURITY STAGES  
OF THE GROUPER SPECIES (SCHEME ADOPTED FROM FERREIRA [1995] &  
ADAMS [2003]).

a) Ovaries	
Maturity Stage	Macroscopic features
I=Immature	Ovary small, strand-like, compact, pink or cream; oocytes (eggs) not clearly distinct; not obviously different from immature or inactive males.

II=Maturing	Ovary relatively small but rounded, less strand-like in appearance, grayish with thickened gonad wall; eggs not clearly distinct and small; Not clearly different from mature males prior to the development of yolk within the eggs.
III=Mature, active	Ovary large and grayish with transparent gonad wall; large yolky eggs becoming clearly visible and tightly packed.
IV-V=Mature, ripe	Ovary relatively large, clear, watery (hydrated) eggs visible through wall; typical of individuals just prior to spawning; egg release possible with application of light abdominal pressure.
VI=Post-spawn (Spent)	Ovary flaccid with obvious capillaries (small blood vessels); few eggs still visible.
<b>b) Testes</b>	
I=Immature / inactive	Testes not obviously different from immature females (see the description of immature females).
II= Maturing	Early Male II individuals are indistinguishable from Female II. Single blood vessel on ventral side. No sperm extricable when pressed lightly.
III= Mature, active	Testes expanding and becoming rounded and large; grayish in appearance; early maturing individuals are not clearly different from maturing females until milt (sperm) becomes evident in the sperm sinus along the gonad wall.
IV-V= Mature, ripe	Testes large and white with sperm visible in sinuses along the gonad wall; milt release with light abdominal pressure.
VI= Post-spawn (Spent)	Testes flaccid and bloody; sperm release still possible on application of abdominal pressure.

#### D. Statistical data analyses

The non parametric Chi-square test (goodness-of-fit test) was used to test for significant deviations from the expected male to female ratio of 1:1, and also to compare numbers within the study sites. Comparison of the landed and visually observed *Epinephelus* genus grouper species proportions was also undertaken using  $\chi^2$  comparison of proportions test using MINITAB release 14 software. The species GSI percentage contributions was also done using the computer MS-Excel spreadsheet package. Dominance, diversity, evenness, spatial, and temporal distribution pattern variations of the visually observed *Epinephelus* genus grouper species off the Kenyan south coast marine water inshore fisheries were determined through Ward's linkage and Squared Pearson Distance cluster method using PAST (Paleontological Statistics version 2.17 programme) software. All statistical tests of significance were determined at  $\alpha = 0.05$ .

### III. RESULTS

#### A. The species composition, dominance, proportions, diversity and distribution patterns

During the study; thirty species comprising of *E. areolatus*, *E. bentoides*, *E. chlorostigma*, *E. coeruleopunctatus*, *E. coioides*, *E. diacanthus*, *E. fasciatus*, *E. fuscoguttatus*, *E. hexagonatus*, *E. lanceolatus*, *E. longispinis*, *E. macrospilos*, *E. malabaricus*, *E. melanostigma*, *E. merra*, *E. miliaris*, *E. multinotatus*, *E. poecilonus*, *E. polyphkadion*, *E. rivulatus*, *E. spilotoceps*, *E. tauvina*, *E. tukula*, *E. chabaudi*, *E. epistictus*, *E. flavocaeruleus*, *E. morrhua*, *E. socialis*, *E. undulosus*, and *E. acanthistus* were landed whereas (28) comprising *E. areolatus*, *E. bentoides*, *E. chlorostigma*, *E. coeruleopunctatus*, *E. coioides*, *E. diacanthus*, *E. fasciatus*, *E. fuscoguttatus*, *E. hexagonatus*, *E. lanceolatus*, *E. longispinis*, *E. macrospilos*, *E. malabaricus*, *E. melanostigma*, *E. merra*, *E. miliaris*, *E. multinotatus*, *E. poecilonus*, *E. polyphkadion*, *E. rivulatus*, *E. spilotoceps*, *E. tauvina*, *E. tukula*, *E. epistictus*, *E. flavocaeruleus*, *E. socialis*, *E. undulosus*, and *E. acanthistus* were visually observed off the Kenyan south coast marine waters. Only two species, *Epinephelus chabaudi*, and *Epinephelus morrhua* were not visually observed during the surveys.

*Epinephelus fasciatus* dominated the landings with 54 individuals followed by *E. malabaricus* (36), and *E. coeruleopunctatus* (31). In the visual surveys; only two species *Epinephelus fasciatus* (64), and *E. coeruleopunctatus* (43) registered counts above (31) individuals. *Epinephelus fasciatus* was still the most dominant species amongst the visual observations. The two groups proportion using  $\chi^2$  test of proportions (Table 2) was found generally not differing

with Msambweni ( $p=0.339$ ) and Shimoni ( $p=0.067$ ). Vanga however had a slight difference ( $p=0.030$ ) similar to that observed when Total Landings and Total Visual Observations were compared ( $p=0.011$ ).

TABLE II:  
THE LANDED AND VISUALLY OBSERVED EPINEPHELUS SERRANID PROPORTIONS (N=NUMBERS) AT THE STUDY SITES; P-VALUE (PROBABILITY OF SIGNIFICANCE AT  $\alpha = 0.05$ ).

Sites / Locations	Landed	Visually observed	N	$\chi^2$	p-value
Msambweni	77	55	132	0.913	<b>0.339</b>
Shimoni	223	224	447	3.331	<b>0.067</b>
Vanga	101	60	161	4.734	<b>0.030</b>
<b>TOTAL</b>	<b>401</b>	<b>339</b>	<b>740</b>	<b>8.978</b>	<b>0.011</b>

In species diversity using Shannon-Wiener diversity index analysis (Table III); Shimoni had the highest diversity index (2.916) in respect to the 223 total landings involving 23 landed species. Vanga with 101 landings involving 18 species was second with (2.627) whereas Msambweni was last with an index of 2.769.

TABLE III  
THE EPINEPHELUS SERRANIDS DIVERSITY OFF KENYA'S SOUTH COAST MARINE WATERS

Landed <i>Epinephelus</i> genera groupers	Msambweni	Shimoni	Vanga
Species	20	23	18
Individuals	77	223	101
Dominance_D	0.07303	0.06308	0.08832
Shannon-Wiener H'	2.769	2.916	2.627
Evenness_e^H/S	0.7969	0.8031	0.7686

The species abundances were generally lower and had varying distribution patterns. Eleven were coastally distributed, (5) common mainly to Msambweni whereas Shimoni and Vanga had common distribution of one species each. This made some species not to be landed in certain areas, or where landed, were less than five individuals. This made the distribution approximation using the  $\chi^2$  p-value invalid and the samples had to be pooled into two categories

to attain the  $\chi^2$  approximation threshold (Table IV). The first consisted of small and medium sized species growing to 31-76cm adult growth lengths whereas the second consisted of the larger bodied and mobile species growing to 80-234cm. The analysis results revealed no significant distribution pattern differences within the study sites between the two categories with small and medium sized species (p-value = 0.416) and the large sized and mobile species (p-value = 0.085). A slight significant difference (p-value = 0.030) however existed on the distribution of the pooled total landings within the sites.

TABLE IV  
POOLED SPECIES DISTRIBUTION PATTERNS DURING THE STUDY; MSAM = MSAMBWENI, SHIM = SHIMONI, VANG = VANGA, N = LANDED NUMBERS, P-VAL = P-VALUE (PROBABILITY OF SIGNIFICANCE AT A = 0.05).

Pooled species landings	Msam	Shim	Vang	N	$\chi^2$	p-val
Small and medium sized	45	162	76	283	2.055	<b>0.416</b>
Large sized and mobile	32	61	25	118	4.926	<b>0.085</b>
<b>TOTAL</b>	<b>77</b>	<b>223</b>	<b>101</b>	<b>401</b>	<b>6.981</b>	<b>0.030</b>

#### B. The species sex ratios and reproductive patterns

A total of 401 individuals were examined and the encountered monthly gonadal maturity stage contributions for the landed *Epinephelus* genera groupers off the Kenyan south coast inshore marine water fisheries during the entire study period. The overall monthly reproductive patterns depicted by fish maturity stages for the encountered *Epinephelus* genera grouper species varied throughout the entire study period.

Inactive fishes (stages I-II) dominated in the first 6 months of study (December, 2013 to May, 2014). Active, ripe, and spent fishes (stages III, IV, V, and VI) were mostly encountered as from April to July, 2014 (SEM season). The inactive fishes with 248 individual landings contributed approximately 61.85% of the total landings. Active fishes with 79 individual landings-19.70%; ripe fishes with 67 individuals-16.71%; and spent fishes of 7 individuals-1.75%. Therefore, taken from the analyzed 401 samples, the gradual increase in the active and ripe stage fishes indicate that the period of highest reproductive activity is from April - July that falls within the SEM season.

## IV. CONCLUSIONS AND RECOMMENDATIONS

### A. Conclusions

The study established the existence of 30 *Epinephelus* genera groupers with varied site distribution patterns with no significant species differences within the Kenyan south coast inshore fisheries. Shimoni with 23 species had the most abundant distribution of *E. rivulatus*, *E. poecilonatus*, *E. bentoides*, and *E. polyphkadion*. Msambweni's 20 species had abundance distribution of *E. flavocaeruleus*, *E. chabaudi*, *E. socialis*, *E. undulosus*, and *E. Morrhuia*. Vanga's 18 species had only one (1) abundance distribution of *E. acanthistus*. Conversely, *E. fasciatus*, *E. malabaricus*, *E. longispinis*, *E. chlorostigma*, *E. coeruleopunctatus*, *E. multinotatus*, *E. merra*, *E. melanostigma*, *E. tukula*, *E. fuscoguttatus*, and *E. tauvina* were found exhibiting coastal-wide abundance distribution patterns. However, when the landing proportions were compared to visual observation proportions where two species (*E. chabaudi* and *E. morrhua*) were not witnessed, the species landing and visual distribution proportions did not significantly differ in Shimoni and Msambweni. Vanga had a slight significant difference similar to that noted between the total landings, and visual observation proportions amongst the 3 study sites. The overall species sex ratios also deviated from unity in favour of females and their size distributions showed high proportions of juvenile fishes suggesting growth overfishing. Mature species were also only landed between April-July, 2014 during the SEM season. Overall, the species catches and abundance were also on the decline with no clear determination of the cause. However, increases in fishing effects and effort due to increased demand for food are suspected to have played important roles.

### B. Recommendations

We recommend that:-

1. The Kenyan State Department of Fisheries (SDF) should encourage the fisher communities to embrace community conservation of spawning stock species.
2. More studies should be undertaken to determine factors leading to the respective species abundance decreases.
3. More multi-scale spatial and temporal movement studies for the larger coral reef fishes should be undertaken for determining how they vary and structure the populations.

## ACKNOWLEDGEMENTS

Ogongo thanks Kenya Coastal Development Project (KCDP) for supporting the work through Kenya Marine &



Fisheries Research Institute (KMFRI) programmes and is indebted also to Joseph Kilonzo, and Sammy Kadhengi for assisting with sampling and laboratory analyses. Boaz also appreciates the Beach management unit (BMU) officials and fishery managers for excellent logistical work, connections, and assistance during data collection..

#### REFERENCES

- [1] Pauly, D., Christensen, V., Guénette, S., Pitcher, T. J., Sumaila, U. R., Walters, C. J., Watson, R. & Zeller, D. (2002). Towards sustainability in world fisheries. *Nature* 418: 689-695.
- [2] Pauly, D., Alder, J., Bakun, A., Heileman, S., Kock, K. H., Mace, P., Perrin, W., Stergiou, K., Sumaila, U. R., Vierros, M., Freire, S., Christensen, V., Kaschner, K., Palomares, M. L., Tyedmers, P., Wabnitz, C., Watson, R. & Worm B. (2005). Marine fisheries systems. In: *Ecosystems and Human Well-being: Current State and Trends, Volume 1* (Eds R. Hassan, R. Scholes and N. Ash). Island Press, U.S.A., pp. 477-511.
- [3] Vincent, A. C. J. (2006). Live food and non-food fisheries on coral reefs, and their potential management. In: *Coral Reef Conservation* (Eds I. M. Côté and J. D. Reynolds). Cambridge University Press, U.K., pp. 183-236.
- [4] Floater, S. R., Halpern, B. S. & Ferreira, C. E. L. (2006). Effects of fishing and protection on Brazilian reef fishes. *Biological Conservation* 128: 391-402.
- [5] Gillett, R. & Moy, W. (2006). Spear fishing in the Pacific Islands current status and management issues. *FAO / Fish Code Review No. 19*, 72pp.
- [6] Chan, T., Sadovy, Y. & To, A. (2007). IUCN Red List of Threatened Species *Epinephelus bruneus*. <http://www.iucnredlist.org/search/details.php/646/su> m Accessed 10th May, 2013.
- [7] Pears, R. J., Choat, J. H., Mapstone, B. D. & Begg, G. A. (2006). Demography of a large grouper, *Epinephelus fuscoguttatus*, from Australia's Great Barrier Reef: Implications for fishery management. *Marine Ecology Progress Series* 307: 259-272.
- [8] Dulvy, N. K., Polunin, N. V. C., Mill, A. C. & Graham, N. A. J. (2004). Size structural change in lightly exploited coral reef fish communities: evidence for weak indirect effects. *Canadian Journal of Fisheries and Aquatic Sciences* 61: 466-475.
- [9] Sadovy, Y. & Domeier, M. (2005). Are aggregation-fisheries sustainable? Reef fish fisheries as a case study. *Coral Reef* 24, 254-262.
- [10] Sadovy, Y. (2005). Trouble on the reef: the imperative for managing vulnerable and valuable fisheries. *Fish and Fisheries* 6, 167-185.
- [11] Robinson, J. M., Samoily, M. A. & Kimani, P. (2008). Reef Fish Spawning Aggregations in the Western Indian Ocean: Current knowledge and implications for management. In: *Ten Years after bleaching: Facing the consequences of climate change in the Indian Ocean*, Obura, D. O., Tاملander, J. and Linden, O. (eds.). CORDIO, Mombasa, Kenya. Pp: 263-276.
- [12] Sale, P. F. (2002). Introduction. In: Sale, P. F. (ed.). *The ecology of fishes on coral reefs*. Academic Press, San Diego, pp.3-25.
- [13] Munday P. L., Buston P. M. & Warner R. R. (2006). Diversity and flexibility of sex change strategies in animals. *Trends in Ecology and Evolution* 21, 89-95.
- [14] Aguilar-Perera A. (2006). Disappearance of a Nassau grouper spawning aggregation off the Southern Mexican Caribbean coast. *Marine Ecology Progress Series* 327: 289-296.
- [15] Heemstra P. C. & Randall J. E. (1993). Vol. 16 Groupers of the World (Family Serranidae, Subfamily Epinephelinae). An Annotated and Illustrated Catalogue of the Groupers, Rock cod, Hind, Coral Grouper and Lyre tail Species Known to Date. *FAO Fisheries Synopsis, No. 125, Vol.16*. FAO, Rome. 382pp.
- [16] Erisman, B. E., Rosales-Csian, J. A. and Hastings, P. L. (2008). Evidence of gonochorism in a grouper, *Mycterperca rosacea*, from the Gulf of California, Mexico. *Environmental Biology of Fishes* 82: 23-33.
- [17] Avise J. C. & Mank, J. E. (2008). Evolutionary Perspectives on Hermaphroditism in Fishes. *Sexual Development* 3: 152-163.
- [18] Rhodes, K. L. & Tupper, M. H. (2007). A preliminary market-based analysis of the Pohnpei, Micronesia, grouper (Serranidae: Epinephelinae) fishery reveals unsustainable fishing practices. *Coral Reefs* 26, 335-344.
- [19] [Nzioka, R. M. (1979). Observation on the spawning seasons of East African reef fishes. *Journal of Fish Biology* 14: 329-342.
- [20] Agembe, S. W. (2009). Some aspects of the biology and fishery of groupers (teleostei: serranidae) in the inshore waters of south coast, Kenya. MSc.Thesis. Moi University.
- [21] McClanahan, T. R. & Graham, N. A. J. (2005). Recovery trajectories of coral reef fish assemblages within Kenyan Marine protected areas. *Marine Ecology Progress Series* 294: 241-248.
- [22] Church, J., Samoily, M., Alidina, H., Waweru, G., Agembe, S. & Kimani, P. (2005). Coral reef fish spawning aggregations in Southern Kenya. In *Western Indian Ocean Proceedings, Mauritius*. 40 pp.
- [23] McClanahan, T. R., Graham, N. A., Calnan, J. M. & MacNeil, M. A. (2007). Toward pristine biomass: reef fish recovery in coral reef marine protected areas in Kenya. *Ecological Applications* 17, 1055-1067.
- [24] Pears, R. J. (2009): Comparative demography and Assemblage structure of Serranid fishes: Implications for conservation and fisheries management. PhD Thesis. James Cook University, Australia.
- [25] Smith, M. M. & Heemstra, P. C. (1986). *Smith's Sea Fishes*. Macmillan South Africa. Johannesburg, 1047 pp.
- [26] Anam, R. & Mostarda, E. (2012). *Field Identification Guide to the Living Marine Resources of Kenya*. FAO Species Identification Guide for Fishery Purposes. Rome, FAO.
- [27] Ramadan, A. M. & El-Halfawy, M. M. (2007). Common forms of Atresia in the ovary of some red sea fishes during reproductive cycle. *Pak Journal of Biological Science* 10: 3120-3125.
- [28] Ferreira, B. P. (1995). Reproduction of the common coral trout *Plectropomus leopardus* (Serranidae: Epinephelinae) from the central and southern Great Barrier Reef, Australia. *Bulletin of Marine Sciences* 56: 653-669.
- [29] Adams, S. (2003). Morphological ontogeny of the gonad of three plectropomid species through sex differentiation and transition. *Journal of Fish Biology* 63: 22-36.

# Analysis of Wind Power Integration for Power System Transient Stability

J. K. Muriuki, C. M. Muriithi and L. M. Ngoo

**Abstract**— Many developing nations are currently undertaking huge electric power generation and transmission expansion to meet the modern consumer power demand. This has been necessitated by the increased power activities and the need for stable power supply. In this paper, Doubly-Fed Induction Generators (DFIGs) are utilized to analyze wind power integration on power system transient stability. Short-circuit fault and intermittent wind power characteristics can be ruinous especially with diverse mix of power being injected to the electricity grid. Wind power is the fastest growing source of renewable energy after hydro generation. As such, wind power integration to the grid has raised concern as to how much more wind power can the grid accommodate and ensure that system transient stability is maintained. This concern has also extended to power system operators and regulators thereby necessitating further analysis. The aim of this paper is to draw some conclusions on what would happen with large-scale wind penetration to the grid on transient stability. The results indicate that as the wind energy integration increases, transient stability improves. However, the level of wind power penetration is only possible to a limit before the system goes unstable.

**Keywords**— Doubly-fed induction generator, Short-circuit fault, Power system transient stability, Wind power integration.

## I. INTRODUCTION

WIND energy generation has been in existence since the ancient times; however its penetration into the conventional grid has continued to attract a lot of interest from researchers worldwide. Currently, many developing countries have a huge energy capacity deficit whereby at peak periods especially when most industrial plants are running, there is insufficient power generation necessary to meet the users demand and retain the reserve capacity. As such, the power system is at risk of collapse especially under fault when the energy reserve is inadequate to maintain the power system transient stability.

The situation is made worse by the generation mix that includes the hydro power, geothermal, nuclear, thermal and the wind power which all have different characteristics. The

latter is there today and tomorrow is unavailable.

Wind power integration to the grid has been there for a long time and researchers have been trying to unravel what amount of wind energy can be integrated to the electricity grid without negatively affecting the power system transient stability. Some of the factors that determine wind integration to the utility electricity grid are: The national energy mix (availability of flexible generation sources -hydro, geothermal), demand for electricity in the country, distribution of wind generation sources, capacity of the grid and wind regime of the different sites contribute to a great role in ensuring there is higher wind penetration in the grid. Further, for greater wind penetration it is important that further studies be carried out to understand the technical challenges that might arise when integrating large wind power to the grid.

Wind integration studies have advanced from whether it is possible to add wind generation to focussing on how it will be done and at what cost [1]. The wind energy generated will address the power shortage capacity, the cost of power and maintain the desired energy reserve. This will in turn stabilize the power system. However, concerns have been raised as to how much wind power should be integrated to the power grid and maintain the power system stability. Many countries have focussed on wind power generation and integration to their conventional generation because it is cheap and environmentally friendly even so, some countries are reluctant to integrate large wind energy to their grid due to shortage of adequate knowledge of large wind power plants. Therefore, it is crucial to achieve a balance between environmental effects and power performance on grid. Further, it is important to study these new aspects that the integration wind power brought to the conventional system, including the aspects of the transient stability and the maximum amount of wind power that can be utilized to a given system [2]. Several researchers have carried out work on the impacts of wind energy on power system stability based on real systems. We can learn from countries with large-scale wind integration experience such as Tasmania, Iberian Peninsula, South Australia, Ireland and US which are at an advanced stage of wind integration into their electricity grid. According to the report on large scale wind integration,

J. K. Muriuki, Department of Electrical and Electronic Engineering, JKUAT (e-mail: jmsmuriuki4@gmail.com).

C. M. Muriithi, Department of Electrical and Power Engineering, TUK

L. M. Ngoo, Department of Electrical and Electronic Engineering, Multimedia University.

an improved forecasting, reduced perception of wind variability and better understanding of the requirements for frequency balancing is crucial [3]. The report further indicates that greater wind penetration is possible with better system control, good government policies and enhanced network. The extent to which the wind power can be integrated into the power system without affecting the overall stable operation also depends on the technology available to mitigate the possible negative impacts such as loss of generation, voltage flicker, and voltage and power variations due to variation in speed of the wind design [4].

## II. EFFECTS OF WIND ENERGY INTEGRATION ON TRANSIENT STABILITY

A stable grid integrated with wind energy should be able to respond to abnormal conditions such as voltage disturbance and faults. Wind farms play a crucial role in voltage stability of the electricity grid under faults because they have better management for reactive and active power. Wind farms have the potential to absorb and supply reactive power on demand. Researchers such as Ch. Eping et al [5] focused on transient stability issues and analyze the impact of various aspects like location of wind generators, connection points and distributed generation. The actual generator technology has a considerable impact on transient stability.

In this study, DFIGs with various penetration levels were analyzed. The results show that this technology improves transient stability margins, when being equipped with low voltage ride-through capability, reactive current boosting and ideally with fast voltage control. In terms of connection point it was shown that integration of wind generation into sub-transmission and distribution systems has a negative impact on transient stability, because the reactive contribution is highly limited due to reactive losses in sub-transmission and distribution systems. They concluded that, in actual cases, there will always be a superposition of the above mentioned aspects, including a variety of generator types and voltage levels to which wind generators are connected. So, there is no general statement possible that state with certainty, if wind generation improves transient stability margins or if the impact is rather negative.

M. El-Sayed and Effat Moussa [6] investigated the effects of wind farms of different sizes on the Egyptian power system. For simplicity and accuracy of the Egyptian system analysis, the wind farm was aggregated into minimal set of equivalent wind generator models combining all turbines with the same mechanical nature frequency into single equivalent turbine. Power system dynamics simulation software is used to study the impact of increasing wind turbine penetration on system performance. The study was also carried out considering different contingencies i.e. transmission line outages, loss of generation units and finally a combination loss of generation and transmission lines. The result shows that the Egyptian system with a total installed capacity of

20400MW can withstand wind farms of size up to 900 MW.

Clemens Jauch et al [7] looked at the effect of wind power on the transient fault behaviour of the Nordic power system. The Nordic power system is the interconnected power system of the countries Norway, Sweden, Finland and Denmark. Here the wind turbines installed in eastern Denmark were used in the investigation. The simulations yielded the information such as how the faults impact on the wind turbines and how the response of the wind turbines influences the post fault behaviour of the Nordic power system.

## III. METHODOLOGY

As per our earlier discussion, concerns have been raised as to how much wind energy should be integrated to the conventional grid without negatively affecting the transient stability. To address the above, this study analyzed a standard IEEE 9 bus of which the results can be extended to any power system depending on the stability of the existing network, location of the wind farm and capacity of the grid.

The fig. 1 shows an IEEE 9 bus system used for the analysis while figure 2 shows a one line diagram of figure 1 connected with a wind farm. The IEEE 9 bus has 3 generators; the generators are replaced with a wind power plant at various levels. A short circuit fault is initiated in a transmission line and the effects of wind integration to the power system are investigated.

Critical clearing time is used to study system stability under initiated system fault. In this paper, critical clearing time is used to determine the longest fault duration allowable for power system transient stability to be maintained. It is the measure used in this paper to analyse the effectiveness of greater wind penetration to the grid. Many questions have been raised about whether greater wind penetration to the grid is secure. This depends on many factors such as the control of the central power plants and on the control applied to other units connected to the grid and also on the topology and the strength of the transmission system itself [8]. The integration levels also depends on generation and demand balance, both real and reactive power through an electricity grid and must be maintained on an almost instantaneous basis to ensure system reliability [9]. This almost real time balance is at the heart of the challenges that exist when integrating any form of generation or demand into an electricity grid.

## IV. SIMULATION RESULTS

In this study two scenarios were looked at. The first involves the study of the effects of transient stability with conventional generation. The 2nd involves analysis of a system with both the conventional generation and wind power plant at different wind integration levels. The two cases are detailed below:



B. With Wind Farm Integration

With wind farm integration at 22%

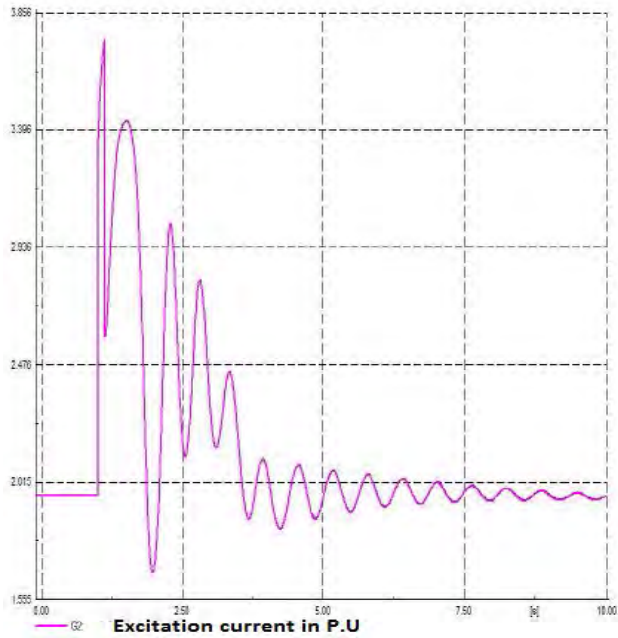

Fig. 5. Behaviour of excitation current parameter for a fault at 1 s cleared at 1.123s.

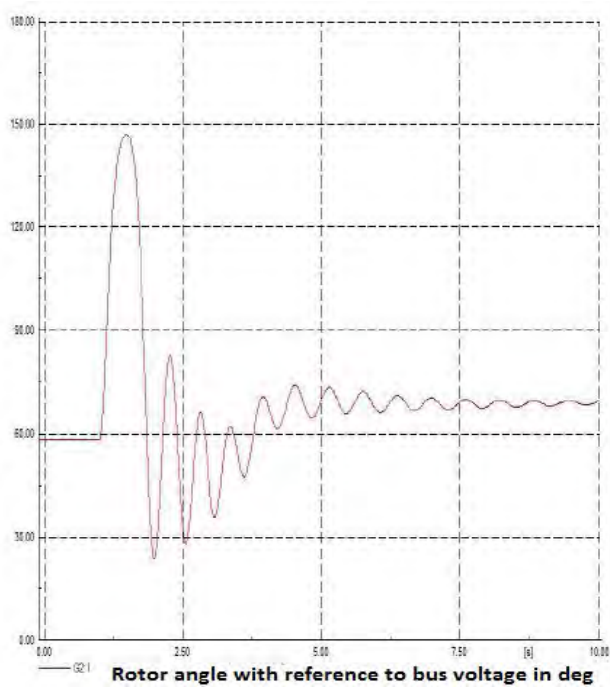

Fig. 6. Behaviour of rotor angle parameter for a fault at 1 s cleared at 1.123s

With wind farm integration at 44%

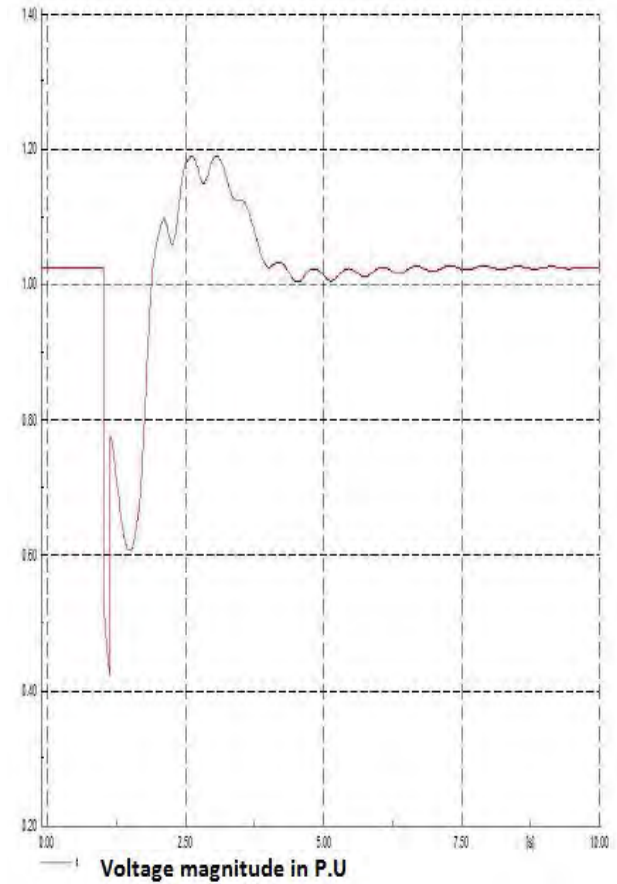

Fig. 7. Behaviour of voltage magnitude parameter for a fault at 1 s cleared at 1.123s.

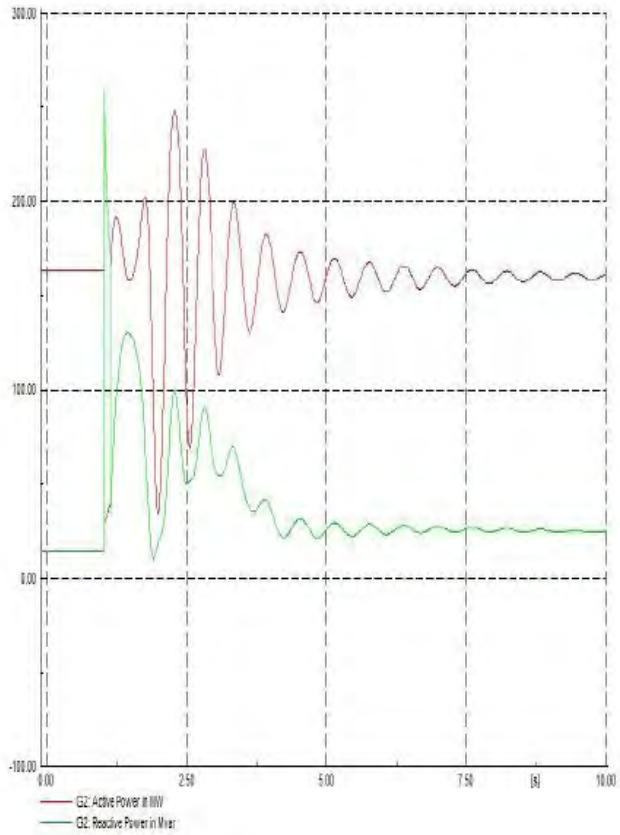

Fig. 8. Behaviour of various SG parameters for a fault at 1 s cleared at 1.123s

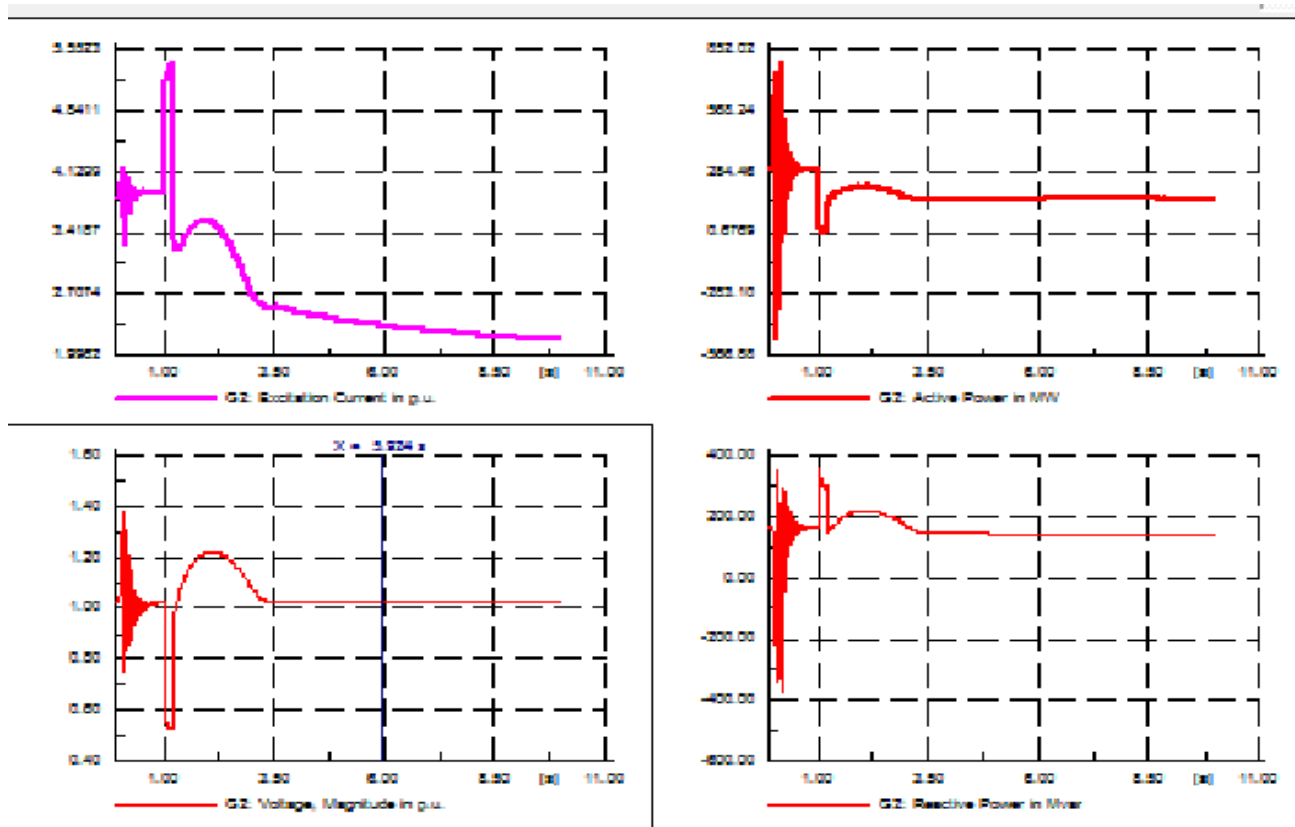

Fig 9. Behaviour of voltage magnitude parameter for a fault at 1 s cleared at 1.12s.

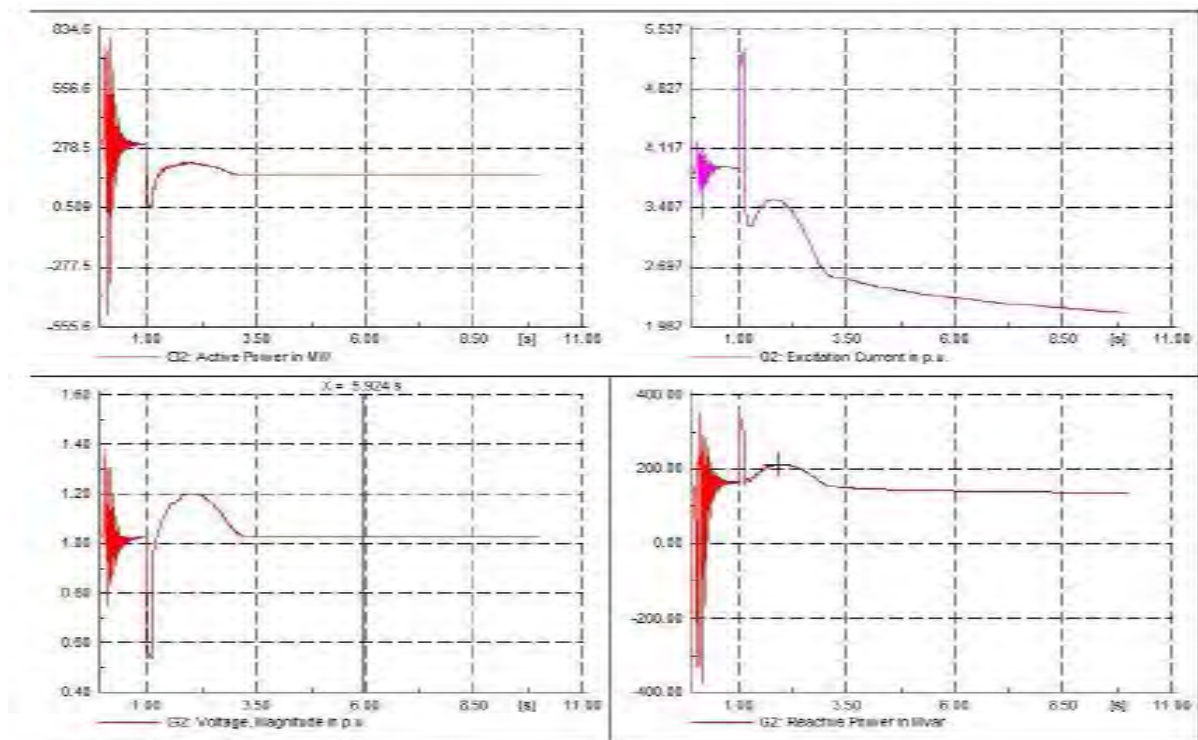

Fig. 10 Behaviour of various SG parameters for a fault at 1 s cleared at 1.12s.

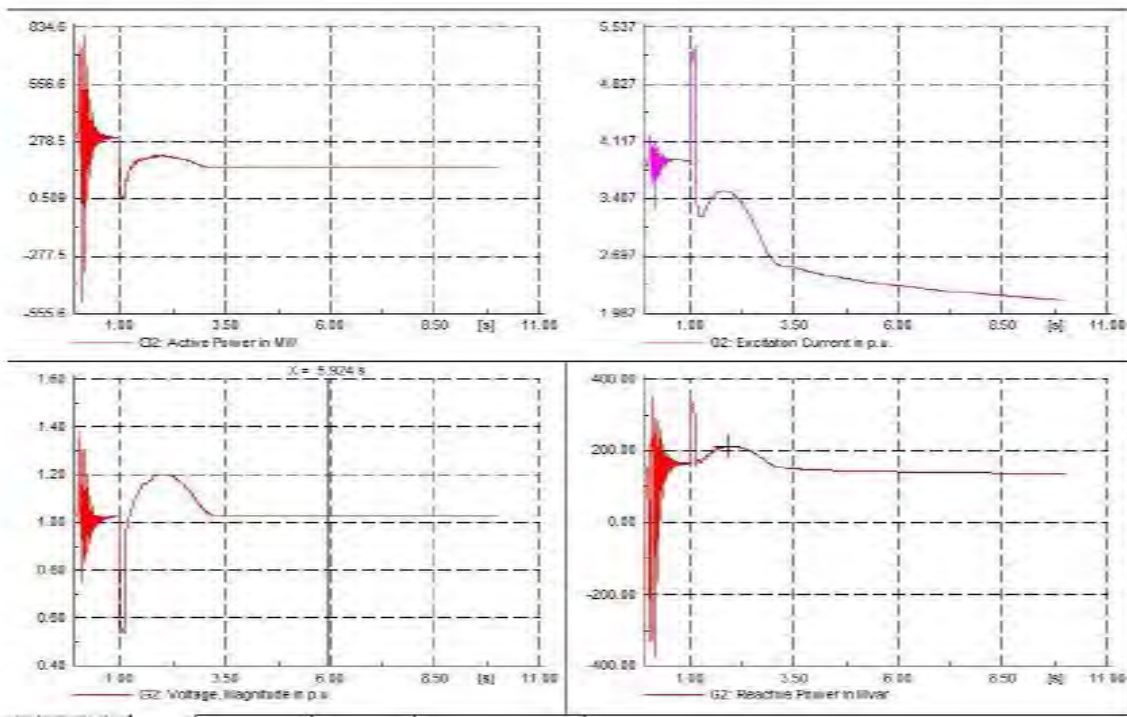

Fig. 11 Behaviour of various SG parameters for a fault at 1 s cleared at 1.118s.

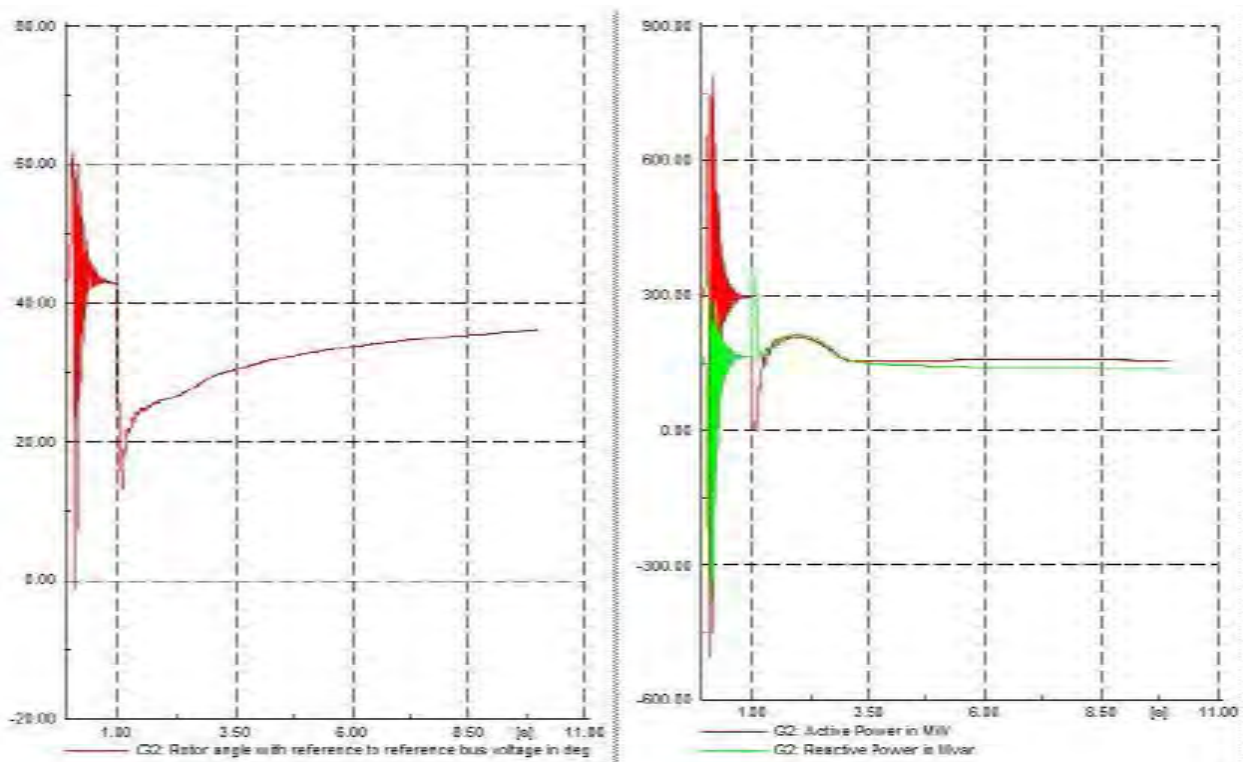

Fig. 12 Behaviour of various SG parameters for a fault at 1 s cleared at 1.118s



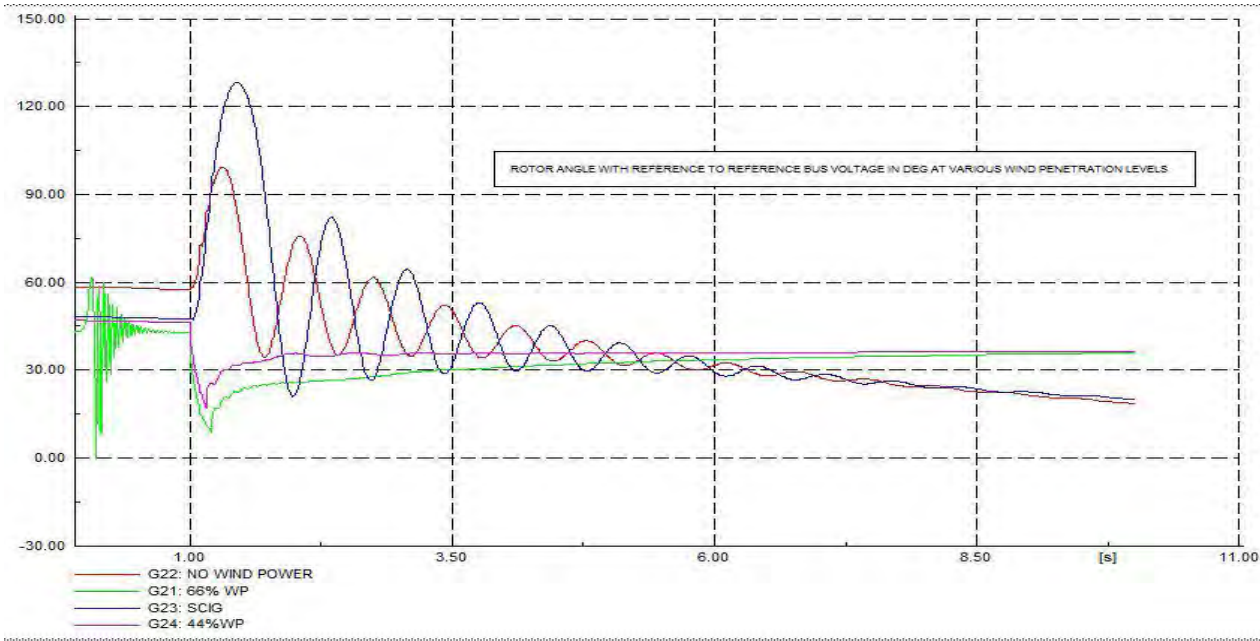

Fig. 13 Effects of wind integration at different levels

## V. DISCUSSION

The figures 3-13 shows the effects of wind power integration. They clearly indicate that as the amount of wind power to the grid is increased, the transient stability improves however; this is only possible to a certain limit before the system goes unstable. It should be noted that wind integration to the conventional generation is crucial and has been a success in other countries where wind penetration is enormous. The same can be replicated in other power system. However, it will depend on the following factors:

- i. The design limits of the transmission line
- ii. Infrastructure standard-this deal with power quality issues.
- iii. The firm capacity of the wind farm and the associated wind power dispatch issues.
- iv. Fast response to abnormal conditions
- v. Active and reactive power management to keep the frequency and voltage within the stable limit
- vi. The energy mix. The distribution sources

Therefore, the degree of success and the level of wind penetration to the system greatly depends on the implementation of the above five factors. Further, more benefits of greater wind penetration can be accrued by investing in the state of the art forecasting equipment thereby improving the reliability of wind.

## VI. CONCLUSION

It has been shown that it is possible to integrate large amount of wind power successfully to the power grid. The degree of this success and the level of wind penetration vary

largely on various factors such as those highlighted earlier. Also, knowing what will happen in the future will make it easier to operate power system and even be more economical. Therefore, investment in reliable wind forecasting devices is crucial in wind integration levels. The results also indicate that as the wind energy integration increases, the transient stability improves. The critical clearing time reduced from 1.123s to 1.118s as the wind power is integrated to the grid. This is a confirmation that greater wind integration is possible if the power network is stable.

It is also crucial to point out that if the grid connection is weak there are possibilities that it will limit the wind power penetration levels. Therefore, for proper planning and operation of the grid with wind farm and to accrue more benefits of greater wind penetration it is vital to ensure that the key factors discussed are implemented in the network.

Similarly, for greater power system transient stability, the conventional generation should be increased significantly to caution against the variability and intermittent wind characteristics. Under such scenario the wind energy is used as the base load supplying large load as compared to conventional generation. However, the controls for both the wind farm and the conventional generation shall be automatic so that under wind variation the latter can automatically be switched on and continue to supply the load with no noticeable interruption. By so doing the power grid will stand a better prospect of allowing greater wind power integration and transient stability improvement.

## REFERENCES

- [1] Jenifer Decesaro and Kevin porter, “, wind energy and power system operations: a review of wind integration studies to date,” subcontract report NREL/SR-550-47256, December 2009.
- [2] Y. Chen and Z. Liu, “Effect of large scale wind farm on transient stability,” International Conference on Electrical and Control Engineering, p. 3680, 2010.
- [3] “Wind integration report in Tasmania,” tech. rep., 2008.
- [4] B. K. N.A.Mutha, S.Arthi, “Improving critical clearing time of grid connected squirrel cage induction generator based on wind generation using DVR,” department of electrical engineering, Indian institute of technology madras, 2012.
- [5] M. P. C h . Eping, J. Stenzel and H. Muller, “Impact of large scale wind power on power system stability,” Institute of Electrical Power Systems (IEPS), 2008.
- [6] M. El-SAYED and E. MOUSSA, “Effect of large scale wind farms on the Egyptian power system dynamics,” 2007.
- [7] I. N. Clemens Jauch, Poul Srensen and C. Rasmussen 2009.
- [8] V.Aichmatov and A. Nielsen, “a small test model of the transmission grid with a large offshore wind farm for education research at technical university of Denmark,” Center for electric technology, 2006.
- [9] A. E. M. Operator, “Wind integration in electricity grids: International practice and experience,” tech. rep., Ecar Energy, 2011

# Fracture Mechanics Approach to Pressure Vessel Failures: A Review

Joseph Mutava<sup>A</sup>, Mutuku Muvengi<sup>B</sup>, Kenneth Njoroge<sup>B</sup>, John Kihiu<sup>B</sup>

**Abstract**— Pressure vessel accidents happen more frequently than they should and cracking is said to be one of the main causes of failure where most of the failures have been traced to surface cracks. To successfully prevent any possible failure of a pressure vessel, one must be able to accurately predict the crack growth behaviour. A lot of studies have been done to provide solution for a range of internal and external surface cracks in pressure vessels. Under normal analysis, linear elastic fracture mechanics (LEFM) approach is mostly applied and therefore majority of these studies have used this approach. This method is not suitable for elasto-plastic fracture behaviour normally exhibited by the highly tough and ductile material from which pressure vessels should be made from. The branch of fracture mechanics applied to a particular problem depends on the mechanics of fracture of the material and therefore, any wrong assumption of the material's fracture behaviour during fracture analysis would lead to some inaccuracies in the final analysis results. Therefore, the actual fracture behaviour of the material is usually overlooked when LEFM and its assumptions is applied in the analysis of elasto-plastic failure of a pressure vessel. Consequently, the review done in this paper describes some fundamental concepts that are commonly missed in the application of fracture mechanics approach to the structural design and failure analysis of pressure vessels. This presents an important subject that requires a serious investigation to be carried out. This is an aspect of knowledge gap that seems not to have been addressed so far by any research study in the available literature work.

**Keywords**— Elasto-plastic failure, Pressure vessel, Linear elastic fracture mechanics.

## I. INTRODUCTION

A pressure vessel may be defined as a closed container designed to hold gases or liquids at a pressure substantially different from the ambient pressure. The inside pressure is usually higher than the outside, except for some isolated cases, such as in submarine vessels, vacuum pump vessels and vessels containing condensing gas or steam. Pressure vessels are of common use in industrial field where they are used as compressed air receivers, heat exchangers, evaporators, autoclaves, nuclear reactor vessels, steam boiler vessels, pneumatic reservoir, hydraulic reservoir under pressure, rail vehicle air brake reservoir, road vehicle airbrake reservoir and storage vessels for liquefied gases such as ammonia, chlorine, propane, butane and liquefied petroleum gas (LPG) [1, 2]. Pressure vessel accidents happen more frequently than they should, in spite of the rigorous efforts put in attempting to enhance their structural integrity. Fracture is said to be one of

the main causes of the failures where most of them have been traced to surface cracks [2].

Pressure vessels are designed to operate safely at a specific pressure and temperature technically referred to as the “Design Pressure” and “Design Temperature”. A pressure vessel has to be able to sustain the stresses imposed on it due to the design pressure, which is the maximum possible pressure the vessel would be subjected to. For most pressure vessels, design temperature is the temperature that corresponds to the design pressure. However, there is a maximum design temperature and a minimum design temperature for any pressure vessel [2, 6]. The most commonly used factor in the design of pressure vessels is that of maintaining the induced stresses within the elastic region of the material of construction in order to avoid excessive plastic deformation or rupture when the yield point is exceeded [2]. An acceptable design and safe operating pressure are achieved when the maximum stress that exists is less than the strength of the material, suitably reduced by a safety factor. All the same, the presence of undetected cracks on the walls of a pressure vessel can severely reduce the strength of the structure and can cause sudden failure at nominal tensile stresses less than the material's yield strength.

Crack appearance and growth can seriously endanger the reliability of structures and components in operation [4]. Therefore, it is important to assess their influence on the structural integrity. To ensure the integrity of a structure when a flaw is present, the designer should understand and adequately apply the mechanics of fracture, particularly the relation between structure loading (applied stress), the flaw size and the fracture toughness. Fracture mechanics quantifies the critical combination of these three variables [3]. Therefore the term “fracture mechanics” refers to a branch of solid mechanics in which the presence of a crack in a solid is assumed and a relationship between the crack length (flaw size), the material's inherent resistance to crack growth (fracture toughness) and the stress at which the crack propagates at high speed to cause structural failure is established. Fracture mechanics can be divided into linear elastic fracture mechanics (LEFM) and elasto-plastic fracture mechanics (EPFM). LEFM gives excellent results for brittle-elastic materials such as high-strength steel, glass, ice and concrete among others. However, EPFM gives excellent results for ductile materials such as low carbon materials, for example steel, stainless steel, certain aluminum alloys and polymers where plasticity will always precede fracture [4]. However, it is not sometimes possible to set clear boundaries between brittle and ductile (plastic) materials, as one and the same material under certain circumstances may behave as brittle one, while under some other circumstances it may behave as plastic one [33]. All in all, the branch of fracture

<sup>A</sup>Department of Mechanical & Automotive Engineering, TUM (phone: +2540723907307; e-mail: jsphkioko@yahoo.com).

<sup>B</sup>Department of Mechanical Engineering, JKUAT

mechanics applied to a particular problem depends on the mechanics of fracture of a material.

## II. THEORETICAL BACKGROUND

### A. Pressure Vessel Construction Material

Generally, almost any material with good tensile properties that is chemically stable in the chosen application can be employed in the construction of a pressure vessel [23]. Besides high yield strength, materials for pressure vessels must be tough and ductile, or in other words its resistance to crack growth should be as high as possible. In addition, ductile materials are used in the construction of pressure vessels and piping because their plastic behaviour provides a warning before crack initiation and some amount of stability in crack growth [20, 21]. Therefore, ductile fracture behaviour results in slow and stable crack growth, which will make it possible for the growing cracks to be detected during routine maintenance by non-destructive testing (NDT) so that corrective measures can be taken before crack growth moves into a high risk regime [24]. More so, slow and stable crack growth can enable a steady crack growth through the wall of the pressure vessel, to form a stable through crack in what is normally referred as leak before break (LBB) methodology [24]. LBB behaviour is an important requirement for the design and re-assessment of pressure vessels, since it provides a good chance for damage to be detected or for the internal pressure to be relieved before sudden catastrophic failure of the vessel [24].

Many pressure vessels are made of steel [5, 23]. From a micro-mechanical point of view, ductile fracture in common structural and pressure vessel steel is generally characterized by the initiation, growth and coalescence of micro voids from impurities such as inclusions and second phase particles, for instance carbide. Ductile crack initiation is preceded by crack blunting occasioned by large scale plastic deformations [3]. EPFM applies to materials that exhibit such kind of plastic deformation before fracture. On the other hand, LEFM is applicable to brittle fracture, whose fracture behaviour results in the development of rapid and unstable crack growth [12] that can easily lead to sudden catastrophic failure of a pressure vessel. Therefore, EPFM must be applied to elasto-plastic failure analysis of pressure vessels for any reasonable results to be realized. The application of LEFM to deal with the elasto-plastic failure would lead to some inaccuracies in the final analysis results.

### B. Elasto-plastic Failure of Pressure Vessels

Highly tough and ductile materials are recommended for the construction of pressure vessels [20, 21]. The failure process (elasto-plastic) of these materials is characterized by a phenomenon of crack faces moving apart prior to fracture [3] as illustrated in Figure 1.

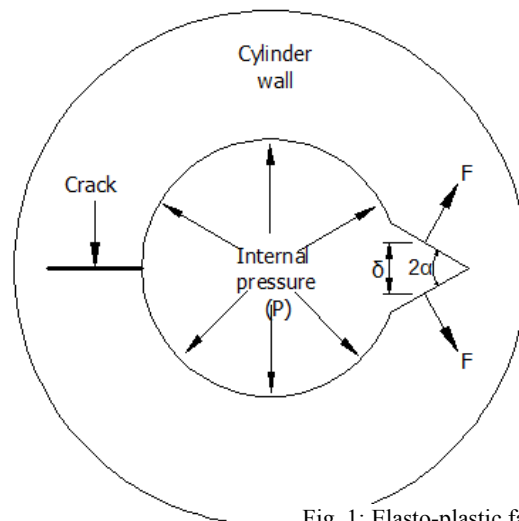

Fig. 1: Elasto-plastic failure

where:  $2\alpha$  - Crack tip opening angle (CTOA)  
 $\delta$  - Crack tip opening displacement (CTOD)  
 $F$  - Force normal to crack surfaces

An initially sharp crack is normally blunted by plastic deformation to enable a significant opening of the crack [3]. Consequently, CTOD and CTOA increase from a value of zero to a maximum critical value before fracture occurs. Similarly, the energy absorbed as the crack opening increases is also proportionally increased to a critical value before fracture occurs. This is the energy required to extend the plastic deformation where an insignificant amount of energy is released when the crack grows [9].  $J$ -integral is the most appropriate parameter to describe this energy requirement during elasto-plastic failure [22]. The  $J$ -integral may be defined as a contour integral characterizing strain energy release rate for a material that exhibits plastic deformation or non-linear elasticity during fracture process [3, 12]. The contour describing the  $J$ -integral is a path-independent line integral which can be drawn around the crack tip and viewed as an energy release rate parameter and sometimes as SIF [3]. When the material behaviour is linear elastic, calculation of  $J$ -integral is relatively straightforward because  $J$ -integral is equal to the strain energy release rate ( $G$ ), and  $G$  is uniquely related to the stress intensity factor (SIF). Computing  $J$ -integral is somewhat difficult when the material is nonlinear or elasto-plastic. In this case, one option for determining  $J$ -integral is to apply the line integral definition, where its value is evaluated by mathematical integration along the arbitrary contour around the crack tip [3].

As the pressure increases and the crack opening proportionally increases, the direction of forces ( $F$ ) normal to the crack surfaces changes continuously. In normal analysis (LEFM approach), it is assumed that no plastic deformation takes place and therefore no blunting occurs of the initially sharp crack. LEFM applies in the limit of small scale yielding of low toughness materials [3], where a slight blunting of the sharp crack tip occurs and causes a relatively small crack opening that does not significantly alter the initial direction of  $F$  as the crack grows. For low toughness materials, brittle

fracture is the governing failure mechanism and critical failure stress varies linearly with the fracture toughness of the material [3]. At high fracture toughness, LEFM is no longer valid and it requires the application of EPFM which is a nonlinear fracture mechanics approach, where failure is governed by the flow properties of the material [3]. Some inaccuracies or errors must therefore occur from the solutions obtained from LEFM application in solving elasto-plastic failures in pressure vessels.

### C. Modes of Failure of Pressure Vessels

Two basic modes of failure are assumed for the design of pressure vessels [5]. These are: Elastic failure, which is governed by the theory of elasticity; and Plastic failure, which is governed by the theory of plasticity. Except for thick-walled pressure vessels, elastic failure is assumed for the design of pressure vessels [5]. When the material is stretched beyond the elastic limit, excessive plastic deformation or rupture is expected.

In a thick-walled pressure vessel, circumferential and radial stresses are initially both maximum on the inner surface. However, failure of the shell does not begin at the bore but in sections on the outer surface of the shell [6]. Although parts on the inner surface reach yield point first, they are incapable of failing because they are restricted by the outer portions of the shell [6]. At a pressure above the elastic-breakdown, the region of plastic flow or "overstrain" moves radially outward and causes the circumferential stress to reduce at the inner layers and to increase at the outer layers resulting to the eventual failure beginning from the outer surface of the vessel where the maximum hoop stress is finally reached [6]. Therefore, plastic failure is assumed for the design of a thick-walled pressure vessel. Two types of analysis are commonly applied to the design of pressure vessels [1]. The most common method is based on a simple mechanics approach and is applicable to thin-walled pressure vessels. The second method is based on elasticity solution and is always applicable to both the thin and the thick-walled pressure vessels [1].

The two modes of failure explained above are related to the traditional approach of structural design where the anticipated design stress is normally compared to the flow properties of the material, where the material is assumed to be adequate if its strength is greater than the expected applied stress [3]. This implies that, the most commonly used factor in the design of pressure vessels is that of maintaining the induced stresses within the elastic region of the material of construction [2]. This is done in order to avoid excessive plastic deformation or failure of the material when the yield point is exceeded. However, the presence of undetected cracks on the walls of a pressure vessel can severely reduce the strength of the structure and that is why there have been incidences of failure of pressure vessels that could not be attributed to strength but to brittle and ductile fracture [7]. Therefore, the fracture mechanics approach to the structural design of engineering components such as a pressure vessel must be applied in order to ensure the structural integrity of the component is guaranteed where there is a real possibility of fracture of the component in service.

### D. Approaches to Fracture Analysis

There are two alternative approaches to fracture analysis: the stress intensity approach and the energy criterion [6]. The stress intensity approach applies an important parameter for the intensity of stresses close to the crack tip called stress intensity factor (SIF or  $K$ ). This parameter completely characterizes the crack tip conditions in LEFM [8], where fracture will occur at a critical stress intensity factor ( $K_{IC}$ ) which is normally a measure of the material fracture toughness. Therefore, the SIF is compared with the  $K_{IC}$  (material fracture toughness value) to determine whether or not the crack will propagate. On the other hand, the energy approach states that, fracture occurs when the energy available for crack growth is sufficient to overcome the resistance of the material. The material resistance may include the surface energy, plastic work, or other types of energy dissipation associated with propagating crack. This approach normally applies the strain energy release rate parameter,  $G$ , where fracture will occur at a critical energy release rate,  $G_C$ , which is a measure of material fracture toughness just as  $K_{IC}$  in LEFM [3, 8]. When dealing with elasto-plastic materials,  $J$ -integral is the suitable alternative parameter to apply, where similarly, fracture (fracture initiation) will occur at a critical  $J$ -integral value,  $J_C$ . However, for the special case of a linear elastic material,  $J$ -integral is equal to  $G$  where the same definition given for energy release rate ( $G$ ) for linear elastic materials still holds. That is, strain energy release rate is the energy that is released from a structure when the crack grows in an elastic material. But when applying  $J$ -integral to elasto-plastic material, it is important to note that, much of the strain energy absorbed by the material is not recovered when the crack grows or the specimen is unloaded [3, 12]. Therefore, the energy release rate concept has a somewhat different interpretation for elasto-plastic materials. Rather than defining the energy released from the body when the crack grows, in this case, the energy required to extend the crack is dominated by the requirement to extend the plastic zone as the crack grows. The surface energy of the new crack faces is negligible in comparison [3, 9].

Since fracture analysis of pressure vessels commonly applies the determination of SIF [10]-[11], it therefore follows that the stress intensity approach to fracture analysis is widely used. However, this approach is not applicable to fracture analysis and testing of the highly tough and ductile material recommended for the design and construction of pressure vessels.

### E. Effect of Plasticity on Fracture Mechanics Approach

Figure 2 illustrates the effect of material plasticity on the crack tip stresses that will also influence the fracture mechanics approach to be applied. Figure 1(a) shows small scale yielding case, where SIF and  $J$ -integral characterize the crack tip conditions [3]. At a short distance from the crack tip, relative to the size of the structure, occurs a  $K$ -dominated region. Assuming monotonic, quasistatic loading, a  $J$ -integral-dominated region occurs in the plastic zone, where the SIF criterion no longer applies [3]. In small scale yielding, SIF uniquely characterizes crack tip conditions, despite the fact

that it does not apply all the way to the crack tip. Similarly,  $J$ -integral uniquely characterizes crack tip conditions even though it does not apply within the finite strain region [3].  $K$ -dominated region definitely implies a zone where LEFM is applicable. Simple corrections to LEFM are available to make it applicable in cases where small scale crack tip yielding occurs [3].

strain zone becomes significant relative to the structure size, and there is no longer a region uniquely characterized by  $J$ -integral. This implies that, a single-parameter fracture mechanics breaks down in the presence of excessive plasticity and fracture toughness will now depend on the size and geometry of the test specimen [3]. Therefore, critical  $J$ -integral values will exhibit a size and geometry dependence.

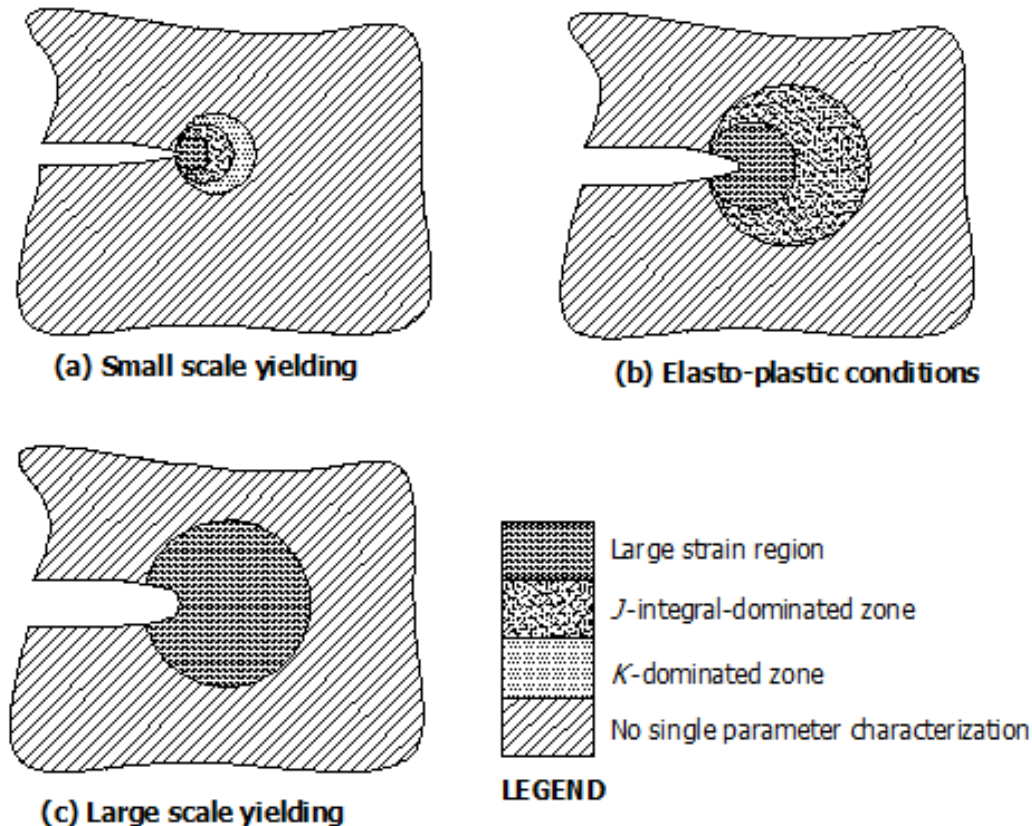

Fig. 2. Effect of material plasticity

For increased plasticity leading to elasto-plastic failure conditions, LEFM criterion is completely not applicable since the  $K$ -dominated region no longer exists as observed from Figure 1(b). The Figure illustrates elasto-plastic conditions, where  $J$ -integral is still approximately valid, but there is no longer a  $K$ -dominated field. As the plastic zone increases in size, relative to the structure size, the  $K$ -dominated zone disappears, but  $J$ -integral-dominated region persists in some geometries. Therefore, although SIF has no meaning in this case, the  $J$ -integral is still an appropriate fracture criterion. Since  $J$ -integral-dominance implies CTOD-dominance, it follows that; CTOD can also be applied to replace the  $J$ -integral in dealing with elasto-plastic fracture behaviour [3]. With large scale yielding (Figure 1(c)), the size of the finite

Since  $J$ -integral deals with both elastic and elasto-plastic material fracture behaviour to some extent; consequently, it makes it a widely acceptable criterion for fracture behaviour comparison of different materials [13].

#### F. Crack Growth Shape Sequence in a Pressure Vessel

Most of the failures of pressure vessel are said to have been traced to surface cracks occurring on the walls of the vessel. A surface crack with any arbitrary shape becomes semi-elliptical after its formation [14, 15]. An axial crack will experience the maximum stress present in the vessel. Therefore, an axially oriented crack becomes more critical than a circumferential crack.

Most of the pressure vessels are cylindrical in shape with 2:1 semi-elliptical heads or end caps on each end [1, 23]. For the purpose of fracture analysis of cylindrical geometries, such as cylindrical pressure vessels, large diameter structures may be generally regarded as “Pipes” while small diameter structures may be called “Tubes” [30]. The failure pressure of a cracked pipe against elasto-plastic failure may be assessed based on the relationship between fracture toughness of the material and the  $J$ -integral, which represents the driving force for elasto-plastic failure [34]. The energy  $J$ -integral distribution along the presumed semi-elliptical crack front can be applied for the assessment of the internal surface crack propagation behaviour in a thick-walled pressure vessel. The initial semi-elliptical crack geometry is as shown in Figure 3

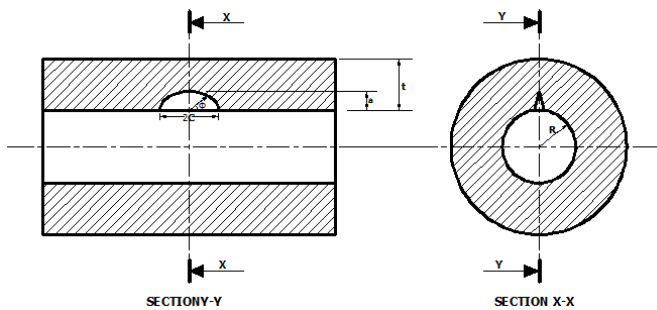

Fig. 3. Geometry of Semi-elliptical Crack

where:  $a$  is the crack depth and  $2c$  is the crack length.

In general, the  $J$ -integral is expected to be a function of the non-dimensional quantities [30]:  $R/t$ ,  $a/t$ ,  $\rho$  and material parameters.  $R$  and  $t$  are the inner radius and wall thickness of the cylinder respectively and  $\rho$  is given by the following equation:

$$\rho = \frac{2c}{\sqrt{Rt}} \quad (1)$$

Equation 2 [16] can be used to provide the required  $J$ -integral distribution along the crack front during elasto-plastic failure of the pressure vessel.

$$J(\phi) = \alpha \frac{\sigma_y}{E} (t-a) h_1 \left( \frac{R}{t}, \frac{a}{t}, \rho, \phi; n \right) \left( \frac{P}{P_L} \right)^{n+1} \quad (2)$$

Where:  $\sigma_y$  – Yield stress of the material

$E$  – Material young’s modulus

$\alpha$  – Dimensionless material constant

$P$  – Internal pressure

$P_L$  – Limit pressure

$h_1$  – Dimensionless function of geometry and material conditions

$n$  – Strain hardening exponent

In the normal analysis, LEFM is applied mostly in the determination of SIFs [17]. The distribution of SIFs along the semi-elliptical surface crack front can be obtained by using the equation given in general form as [18]:

$$K(\phi) = \frac{PR}{t} \sqrt{\frac{\pi a}{Q}} F_e \left( \frac{a}{c}, \frac{a}{t}, \frac{t}{R}, \phi \right) \quad (3)$$

Where,  $Q$  is given by:

$$Q = 1 + 1.464(a/c)^{1.65} \quad (4)$$

An expanded expression for  $F_e$  is obtained from SIFs handbook [18]. Equation 3 is valid for  $5 \leq R/t \leq 20$ ;  $2c/a \leq 12$  and  $a/t \leq 0.8$  [3] and therefore it can be applied for both thin ( $R/t > 10$ ) and thick-walled ( $R/t < 10$ ) pressure vessels to some extent.

In the case of linear elasticity where small scale yielding prevails, the energy release rate  $G$  can be equated to the energy  $J$ -integral and related to the SIF as shown in Equation 5 [18, 19].

$$J = G = \frac{K_I^2}{E'} \quad (5)$$

Where:  $E'$  is equal to Young’s Modulus ( $E$ ) of the material for plane stress and for plane strain,  $E'$  is given by Equation 6 [18, 19].

$$E' = \frac{E}{1-\nu^2} \quad (6)$$

The characteristics of the material properties, stress-strain state and fracture would vary continuously along the semi-elliptical crack front from plane strain conditions at the free surface to the plane stress conditions at the deepest point of the crack [18]. Therefore, the critically stressed point which normally occurs at the crack deepest point is characterized by plane stress conditions.

A numerical analysis of the semi-elliptical surface crack that applies Equation 2 and 3 can be carried out to give results of the respective  $J$ -integral and SIF distribution along the crack front (defined by the elliptic angle  $\phi$ ), as a parameter for different crack extensions. The results for  $J$ -integral distribution to be obtained can be used in predicting crack growth shape sequence during elasto-plastic failure of a pressure vessel. On the other hand, SIF distribution results obtained would be suitable in predicting the same crack growth behaviour, but for linear elastic failure of a pressure vessel.

### III. RESEARCH STUDIES

From the available literature work, it is evident that considerable efforts have been put in the analysis of fracture susceptibility and failure of flawed pressure vessels. Different methods and approaches have been applied in a very rigorous attempt to provide the necessary solutions. Osama *et al.* [20] studied the behaviour of ductile crack growth in surface cracked pressure vessels. In the study, non-dimensional results were presented and it was observed that a vastly different crack sequence develops under ductile tearing conditions compared to fatigue and the stress intensity dominated crack growth. The conclusion was that, the crack shapes developed under LEFM conditions would therefore no longer be applicable to ductile tearing scenarios. However, the authors did not establish the magnitude of inaccuracies bound to occur due to the application of LEFM in solving elasto-plastic failure in pressure vessels. In addition, the authors did not take into account the effect of the high internal pressure on the crack face, which must have some influence on the crack growth behaviour.

Margolin *et al.* [26] studied modelling of ductile crack growth in reactor pressure vessel steels and presented a method for predicting  $J_R$  curves for reactor pressure vessel steels. According to the authors, the  $J_R$  curves are used to assess the integrity of reactor pressure vessels in the ductile fracture region. Generally,  $J_R$  curves are used for characterizing ductile fracture behaviour of metallic components, where the entire curve can be used to describe the ductile fracture. However,  $J_R$  curve alone cannot be used to predict a complete crack growth shape sequence which tells how a crack evolves to clearly define crack growth behaviour. Mundhe and Utpat [8] performed analysis of a cracked cylindrical pressure vessel by using experimental approach. The study applied LEFM approach in determination of SIF of cracked cylindrical pressure vessel made of brittle epoxy. The authors observed that, the strain gauges they used in the experiment gave good results to calculate the required SIFs. The pressure vessel material used was brittle in nature and therefore it is not recommended for the construction of pressure vessels.

Salam *et al.* [27] carried out a study on crack growth prediction in a thick cylinder under fatigue loading by finite element analysis (FEA) and presented a numerical analysis to predict crack growth under fatigue loading in a thick cylinder made of an aluminium alloy. In the study, experimental crack growth data on middle tension (MT) samples available was applied to simulate and predict crack growth process. It was observed that, in crack growth analysis, FE model provides results optimized for the stress levels of 25 to 40% of the yield stress, but for the stress levels of 15 to 20% the model provides more conservative results. The fatigue crack propagation was simulated based on LEFM determination of SIF method, which is considered unsuitable for the analysis of pressure vessel ductile material fracture behaviour.

Emina *et al.* [28] carried out structural integrity analysis of cracked cylindrical pressure vessel by determining its crack tip stress field state and evaluating the resulting total  $J$ -integral. It was noted that, acknowledgement of material fracture behaviour was not only important in order to avoid failures,

but also to enable maximum economy of material choice and amount used. For enhanced assessment of structural integrity of a pressure vessel, the complete shape variation of the advancing crack during fracture process needs to be understood. Total  $J$ -integral alone is not capable of providing this but it would require a criterion that can present the energy  $J$ -integral distribution along the crack front. This is something that the study failed to address.

Iftikhar [29] carried out analysis of crack propagation in a thick-walled extruded cylinder of an aluminium alloy (AA 6061 T6) under fatigue loading. The fatigue crack propagation was analysed through detailed experimental work and FEA where fatigue crack growth life of the cylinder with a crack at the bore surface was predicted. The FEA, based on LEFM combined with Paris's law, suitably predicted the fatigue life. The authors found out that, for a stable crack growth prediction under constant amplitude loading, an element size of 0.05mm along the crack propagation was sufficient to produce optimized results. However, slow and stable crack growth is a characteristic behaviour commonly demonstrated by ductile fracture process, which cannot be addressed by the technique applied in the study.

Guerrero *et al.* [26] carried out fracture analysis of pressure vessel made of high strength steel P500 (yield strength: 500MPa) assuming the existence of the "worst case" crack allowed by the European Standards in order to demonstrate the safe use of these steels and the too conservative design which was being applied by the pressure vessel manufacturing codes. The three principal stress distributions along the crack tip were presented and it was observed that, the axial stress acted normal to the surface of the crack and was therefore the one that caused the crack to open. A fracture mechanics analysis was conducted to determine the magnitude and distribution of the SIF along the tip of the crack under the design loads. However, to avoid spontaneous fracture, the structural steel recommended for the construction of pressure vessels need to be a ductile material whose failure cannot be analysed by the LEFM method applied in the study. In addition, a significant crack opening during fracture process is something identifiable with elasto-plastic failure and cannot be appropriately described by SIF distribution along the crack front, which is a LEFM technique.

Salam *et al.* [30] did experimental and numerical study of fatigue crack propagation in a thick-walled cylinder under cyclic hoop stress. After finding the anisotropy resulting in dissimilar properties in different orientations of thick-walled cylinder, experimental and numerical study was performed to reveal the fatigue crack growth behaviour of the cylinder under cyclic hoop stress. Fatigue crack growth experiments were conducted on MT samples prepared in an orientation to simulate the hoop stress on the cylinder. The fatigue life analysis results obtained from both the techniques showed that, the fatigue lifetime increased as the stress range decreased. The fatigue crack propagation was simulated, based on LEFM determination of SIF at the crack tip. All the same, for a better description of crack growth behaviour, the determination of SIF at the crack tip cannot solely be relied upon, but its distribution along the crack front can possibly assist a lot in the LEFM approach.



Adnan *et al.* [31] did estimation of the life of a thick cylinder subjected to internal pressure using FEM with  $J$ -integral approach. In the study, numerical strain energy release rate was evaluated for the thick cylinder and the resulting SIFs were determined. The authors attempted to demonstrate the proficiency of 2-dimensional (2D)  $J$ -integral program for LEFM, which they developed in their study for analysis of cracked structures and whose application was proved and verified. It was observed that, the determination of SIF for structures having two or more cracks would never take the total path  $J$ -integral because it was mathematically illogical and therefore such cases could be determined using superposition. All in all, the  $J$ -integral application in LEFM cannot be used in the analysis of elasto-plastic failure preceded by a significant amount of plasticity.

Xin *et al.* [32] applied a Cohesive Zone Model (CZM) based approach with a 3-dimensional (3D) finite element method (FEM) to simulate stable tearing crack growth events in Arcan specimen made of 2024-T3 aluminium alloy. With the same set of CZM parameter values, simulations were performed for mixed-mode I/II conditions. The results suggested that CZM based simulations could predict the critical CTOD values, which are conventionally used as input in CTOD-based stable tearing simulations and were obtained from experimental measurements. Analysis of stable crack growth plays an important role in assessing the structural integrity of critical engineering structures such as pressure vessels. However, the study did not establish the stable tearing crack growth shape sequence, which describes crack growth behaviour more clearly and conclusively.

#### IV. CONCLUSION

Highly tough and ductile materials are recommended for the construction of pressure. In the normal failure analysis of pressure vessels, LEFM approach is applied, though it is not suitable for addressing failures that are associated with ductile materials. LEFM is suitable and appropriate when dealing with failures of brittle or linear elastic materials. Sometimes, it is not possible to set clear boundaries between brittle and ductile or plastic materials, as one and the same material under certain circumstances may behave as brittle one, while under some other circumstances it may behave as plastic one. Therefore, it is possible to apply LEFM in cases where EPFM should have been applied or vice versa. Consequently, it becomes important to consider the extension of the available research work in a new direction of study that requires the understanding of the effects that occur due to the application of the wrong fracture of mechanics approach. Application of the wrong fracture mechanics can be occasioned by making wrong assumptions of the material's fracture behaviour during fracture analysis which would lead to some inaccuracies in the final analysis results. These inaccuracies need to be studied and investigated in an effort aimed at enhancing the structural integrity of the pressure vessels.

#### REFERENCES

[1] Vishal V., Saidpatil and Arun T. S. "Design and weight optimization of pressure vessel due to thickness using finite element analysis," *International Journal of Emerging Engineering Research and Technology*, vol. 2, pp. 1-8, 2014.

- [2] Prem N., "Pressure vessel design," tech. rep., Safetyline Institute Work and safety practitioner, Department of commerce State of Western Australia, 2012.
- [3] Anderson T.L, *Fracture Mechanics Fundamentals and Applications*. CRC Press, second ed., 1995.
- [4] Goran V. and Josip B., " $J$ -integral as possible criterion in material fracture toughness assessment," *Engineering Review*, vol. 31, Issue 2, pp. 91-96, 2011.
- [5] Somnath C., "Pressure vessels design and practice - overview of pressure vessels," tech. rep., Mechanical and Aerospace Engineering series, 2005.
- [6] Dennis M., *Pressure vessel design manual*, third edition. Gulf professional publishing, 2004.
- [7] Somnath C., "Ac 2008-2887: Material selection for a pressure vessel," tech. rep., American society for Engineering Education, 2008.
- [8] Mundhe N. D. and Utpat Abhay A., "Analysis of cracked cylindrical pressure vessel by using experimental approach," *International Journal of Latest Trends in Engineering and Technology (IJLTET)*, vol. Vol. 2 Issue 3, pp. 155-160, 2013.
- [9] Hearn E. J., *Mechanics of Materials 2 - The Mechanics of Elastic and plastic Deformation of solids and Structural Material*, 3rd edition. British library of congress.
- [10] Azhdari K. and Rastgu A., "Stress intensity factor and fatigue life prediction in thick wall vessels by using of weight function," *Proceedings of the 3rd BSME-ASME International Conference on Thermal Engineering*, pp. 1-7, 2006.
- [11] Moulick S. K. and Sahu Y. K., "Stress intensity factor for internal cracks in thick walled pressure vessels using weight function technique," *National Conference on Innovative Paradigms in Engineering & Technology (NCIPET)*, pp. 6-12, 2012.
- [12] Xian-Kui Z. and James A. J., "Review of fracture toughness ( $G$ ,  $K$ ,  $J$ , CTOD, CTOA) testing and standardization," *Engineering Fracture Mechanics*, vol. 85, pp. 1-46, 2012.
- [13] Goran V. and Josip B., " $J$ -integral as possible criterion in material fracture toughness assessment," *Engineering Review*, vol. 31, Issue 2, pp. 91 {96, 2011.
- [14] Nishioka T. and Atluri S. N., "Analysis of surface flaw in pressure vessels by a new 3-dimensional alternating method," *Journal of Pressure Vessel Technology*, vol. 104/299, pp. 1-9, 1982.
- [15] Hadi K. and Majid Reza A., "Finite element analysis of a semi-elliptical external crack in a buried pipe," *Transactions of the canadian society for mechanical engineering*, vol. 33, pp. 399-409, 2009.
- [16] Prasanta K. P., Shrivastava S. K. and Sumit B., "Numerical analysis of crack initiation and growth in cylindrical geometries with an axial flaw," *International Journal of Fracture.*, vol. 148, pp. 291-301, 2007.
- [17] Pineau A. "Modelling of ductile to brittle fracture transition in steels micromechanical and physical challenges," *International Journal of Fracture*, vol.150, pp. 129-156, 2008.
- [18] Shlyannikov V. N. and Chadaev D. A., "Analysis of shape variation of a fatigue surface crack in a pipeline," *Strength of materials*, vol. 35, pp. 490-499, 2003.
- [19] Yang Y. "Stress intensity factors of circumferential semi-elliptical internal surface cracks of tubular member subjected to axial tensile loading" *Msc. in Civil Engineering*, Faculty of Science and Technology, University of Macau, 2010.
- [20] Osama A., Terfas and Abdusalam A. A., "Ductile crack growth in surface cracked pressure vessel," *International Journal of Mechanical, Aerospace, Manufacturing, Industrial Science and Engineering*, vol. 7 No:1, pp. 27-33, 2013.
- [21] Sunghwan J. and Hyungyil L., "Crack-tip field characterization of crack-tip opening angle- based crack growth plane strain single-edge cracked specimen subject to pure extension," *Journal of Mechanical Science and Technology*, vol. 25 (5), pp. 1207-1213, 2011.
- [22] Matvienko YU.G. and E.M. Morozov, "Calculation of the energy  $J$ -integral for bodies with notches and cracks," *International Journal of Fracture*, vol. 125, pp. 249 {261, 2004.
- [23] Thakkar B. S. and Thakkar S. A., "Design of pressure vessel using ASME code, section viii, division 1," *International Journal of Advanced Engineering Research Studies*, vol. 1, pp. 1-7, 2012.
- [24] Sarka P. and Howard T. "Theoretical background of "leak before-break" as a concept in pressure vessels design," *Metal* 2002, vol. 5, pp. 14-16, 2002.

- [25] Tobias B., "Numerical simulation of ductile crack growth in residual stress fields," *Swedish Radiation Authority*, vol. 28, pp. 1-63, 2014.
- [26] Margolin B. Z., "Modeling of ductile crack growth in reactor pressure vessel steels and determination of  $J_R$  curves," *Strength of materials*, vol. 34, pp. 120-130, 2002.
- [27] Salam I., Abid M., Malik M. A., "Crack growth prediction in a thick cylinder under fatigue loading an FEA," *International Journal of Systems Applications, Engineering & Development*, vol. 3, pp. 51-55, 2007.
- [28] Emina S. D. and Jasmina V. L., "Structural integrity analysis of a cracked cylindrical pressure vessel  $J$ -integral," *Trends in the Development of Machinery and Associated Technology (TMT)*, pp. 599-602, 2012.
- [29] Iftikhar us S., Analysis of crack propagation in a thick-walled cylinder under fatigue loading. PhD thesis, College of Electrical and Mechanical Engineering National University of Sciences and Technology (NUST), 2008.
- [30] Guerrero M. A., Betegon C. and Belzunce J., "Fracture analysis of a pressure vessel made of high strength steel (HSS)," *Engineering Failure Analysis*, vol. 15, pp. 208-219, 2008.
- [31] Adnan Jamel N., Mad Husein A. and Akeel Abtan A., "Estimation of the life of thick cylinder subjected to internal pressure with manufacturing cracks using  $J$ -integral method," *Journal of Engineering*, vol. 11, pp. 79-89, 2005.
- [32] Xin C., Xiaomin D. and Michael A. S., "Simulation of stable tearing crack growth using the cohesive zone model approach," T. Proulx (ed.), *Experimental and Applied Mechanics, Conference Proceedings of the Society for Experimental Mechanics Series 9999*, vol. 6, pp. 537-542, 2011.
- [33] Marko R., Zorica C., Vencislav G., Milo K., "Micromechanism of ductile fracture initiation, void nucleation and growth," *FACTA UNIVERSITATIS – Mechanical Engineering series*, vol. 6, pp. 825-833, 2000.

# Simulation of Drying Uniformity inside Hybrid Solar Biomass Dryer using ANSYS CFX

Jackis Aukah., Mutuku Muvengei., Hiram Ndiritu and C. Onyango

**Abstract**— In a hybrid solar biomass system, a combined solar radiation with biomass heating source is employed in order to have a double heating of the drying air. The dryer is of tunnel type where the collector and the drying tunnel are fabricated as one unit. The trays in the drying chamber are arranged horizontally at the same level slightly above the absorber plate. Solar hybrid dryers present a viable option for drying of maize since continuous drying can be achieved. However, non-uniform drying of the product may occur in the drying chamber due to poor air flow distribution. The aim of this study was to develop a mathematical model for predicting the drying uniformity within the drying chamber of a hybrid solar biomass tunnel dryer. The model consists of the full set of partial differential equations that describe the conservation of mass, momentum and heat inside the dryer. The standard  $k-\epsilon$  model was used to describe turbulence in addition to the governing conservation equations. The simulation was done using ANSYS CFX which is a general purpose Computational Fluid Dynamics (CFD) package. The simulated air flow pattern and temperature distribution on the horizontal and vertical planes in the drying chamber was analyzed and the result revealed spatial homogeneity of drying air condition. However the velocity profile was higher at the inlet and outlet. The increase of the velocity at the exhaust stack was due to the reduction of flow cross-section area as well as chimney effect.

**Keywords**— ANSYS CFX, Drying uniformity, Hybrid solar biomass dryer, Simulation,

## I. INTRODUCTION

**D**RYING is an essential process used all over the world for the preservation of farm produce. It helps in reducing the water activity of the produce to a level below which deterioration does not occur for a definite duration [1]. The drying process helps to achieve better product quality, longer safe storage period and reduction in post-harvest losses. The reduction in post-harvest losses ensures more food availability for growing world population [2]. Various drying methods are employed to dry different types of food produce. Natural sun drying is the oldest method of food preservation. However, it

has several drawbacks, such as the difficulty to control the rate of drying, insect infestation and microbial contamination. Replacing natural sun drying by conventional dryers or by solar dryers can significantly reduce these drawbacks and the losses caused by them. Nevertheless, the drying air characteristics in solar dryers depend on ambient conditions, which can reduce the quality of the final product.

Conventional or mechanized drying requires higher operational costs and such units are beyond the reach of farmers with limited product volume and financial resources. Moreover, the increasing rate of fuel consumption in agriculture has made it necessary, not only to save energy by intensifying the drying process, improving designs and using renewable energy sources for drying processes [3]. Solar drying has been used for a very long time and it is an effective method to preserve farm produce. Solar dryers depend on the intensity of the solar radiation to heat up the air and effect drying, but the drying process is interrupted during cloudy, rainy seasons and at night. Therefore, integration of an auxiliary heating source is essential for solar dryers to operate continuously. In this context, hybrid solar dryers present an interesting solution [4]. In hybrid solar-drying the characteristics of the drying air can be controlled, hence improving the quality of dried products and reducing the drying costs. The key factors considered in the development of solar-assisted drying systems for agricultural produce are compact collector design, high efficiency, integrated storage, and long-life drying system. In hybrid dryers, the drying process is not so dependent on the incident solar radiation, since an auxiliary source of energy can be used to maintain uniform drying conditions.

In tropical and subtropical countries, a large proportion of grain (such as maize) is harvested and stored under hot and humid conditions, and most farmers lack proper knowledge, equipment and methods of drying grains [5]. Subsequently, grain is stored while still relatively moist and warm environment. However both warmth and high moisture contents can result in rapid deterioration of the grains and promote the growth of microorganisms (e.g. fungi and bacteria) and insects in the grains [6]. To maintain high quality maize during storage, maize should be protected from extreme weather (including relative humidity and temperature), growth of microorganisms, and insects [7]. Tuite and Foster [8] also reported that insects in grain enhance mould development because they increase moisture content and temperature, and open areas of the grain for attack. Fungal growth in maize is facilitated by hot and humid conditions. It has been reported in

Aukah J., Kenya Industrial Research and Development Institute, KIRDI (corresponding author to provide phone: +254072228281; e-mail: aukajakiz@gmail.com).

Muvengei M., Author, Department of Mechanical Engineering, JKUAT (e-mail: author@eng.jkuat.ac.ke).

Ndiritu H., Department of Mechanical Engineering, JKUAT (e-mail: authors@eng.jkuat.ac.ke)

Onyango C., Kenya Industrial Research and Development Institute, KIRDI (e-mail: author@eng.jkuat.ac.ke)

various studies that fungal infestation in maize results in colour changes, decrease in nutritional values, and reduction of overall quality of the maize [9].

Jackis et al. [10] designed a hybrid solar biomass tunnel dryer (HSBD) to address the challenges faced by rural maize farmers in Kenya. This dryer combines the advantages of solar- and biomass-powered drying systems. A biomass heating system was chosen for auxiliary heating source since biomass is locally available in rural areas and is often the cheapest source of energy. Solar tunnel dryers have previously been used with success for drying grain with considerable reduction in grain losses, and they offer numerous advantages such as protection of drying material from contamination, quick and uniform drying, and superior milling and germination qualities. One of the most important aspects of the drying technology, especially for industrial processes, is modeling of the drying processes. The purpose of modeling is to allow engineers to choose the most appropriate method of drying a given product, as well as suitable operating conditions. Full-scale experiments for different products and system configurations are sometimes costly and not feasible. Therefore, prediction of drying kinetics of specific crops under various conditions is very useful in design and optimization of dryers. The aim of this study was to develop a mathematical model for predicting uniform airflow distribution throughout the drying chamber using CFD simulation. Simulation was done in several horizontal planes inside the drying chamber to determine the tray position with better airflow distribution in the HSBD.

## II. METHODS AND SIMULATION

### A. Description of Experimental setup

The developed HSBD consists of three main parts namely; solar collector, drying chamber and biomass auxiliary heating chamber all fabricated as one single unit (Fig. 1).

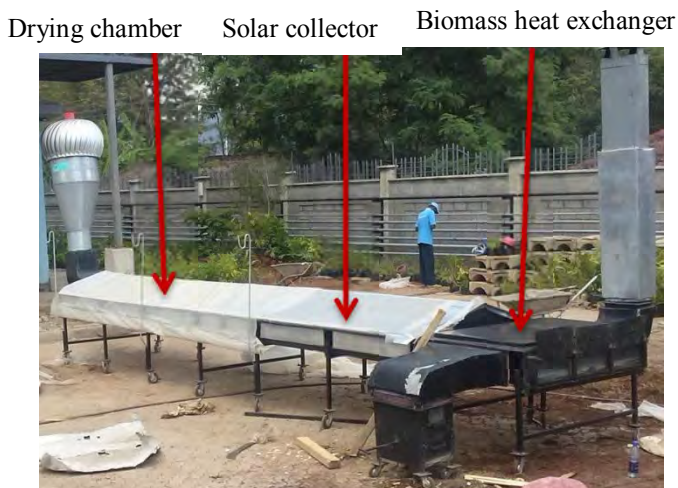

Fig. 1: Assembled biomass stove heat exchanger system

Each part of the dryer was designed to be detached and

assembled without difficulty for shifting purposes from one place to another and also mounted on caster wheels for easy mobility. The top surfaces of the collector and drying chamber was designed in triangular shape and both chambers covered with UV-stabilized plastic sheet. Black paint was used to help the plate to collect solar radiation and convert it into heat energy and transfer the heat to the air surrounding the plate during the day when sufficient solar radiation is available. The main tunnel dryer frame was made of mild steel square hollow tube and angle lines with pieces of hardwood arranged at the bottom part to act as insulation material to reduce heat loss from the bottom of the dryer. The pieces of the hardwood at the bottom were covered with alluminium painted galvanized iron sheet (GI) to reflect energy incident on the surface. Similarly, the side walls of the tunnel chamber were made of alluminium coated GI sheet riveted on the main frame.

The dryer was designed to dry approximately 15 kg (wet basis) of maize in one tray per batch. The drying chamber of the dryer can accommodate six trays made of perforated plastic mesh fixed on alluminium angle line frame as shown in Fig. 2. The trays are arranged horizontally at a higher level above the absorber plate to allow for smooth flow of drying air on top and beneath the maize preventing the need to turn it during drying as shown in Fig. 3.



Fig. 2: Tray details



Fig. 3: Tray arrangement in the drying tunnel of the HSBD

To reduce its dependence on solar radiation for operation and to improve the quality of drying, a biomass stove - heat exchanger system was incorporated in this dryer, thus converting it to a hybrid dryer. The biomass stove-heat exchanger system as shown in Fig. 4 was designed mainly to compliment the solar energy supply to the dryer, and to sustain the drying process during cloudy weather. In addition it can also be used to extend the period of drying beyond sunshine hours and during night as well, while drying high value addition crops.

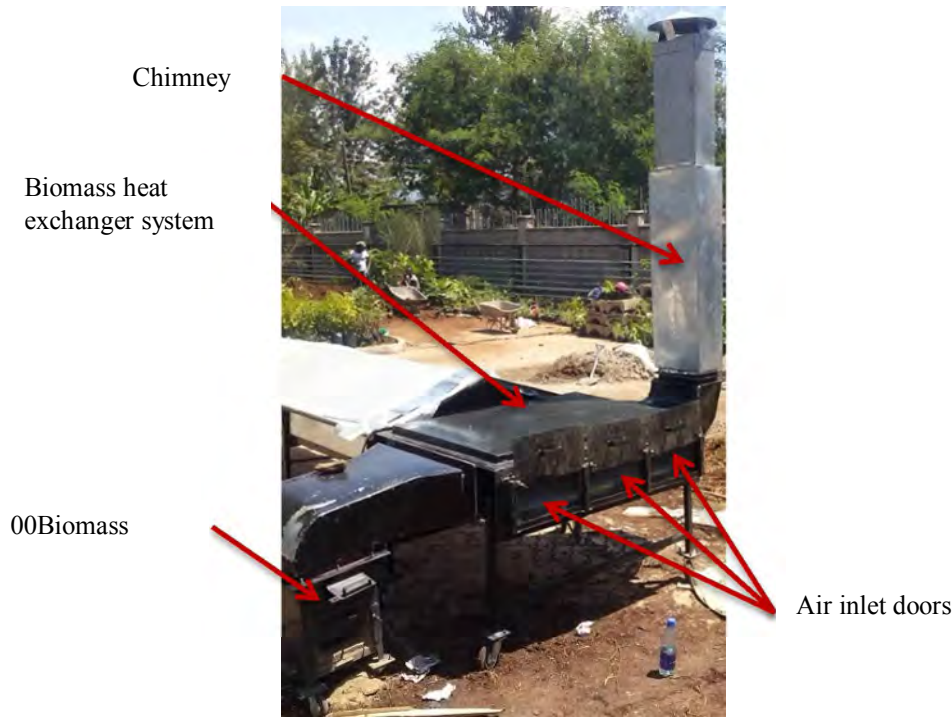

Fig. 4: Assembled biomass stove heat exchanger system

The whole dryer system was designed to be disassembled into small parts during transportation and also supported on a base frame mounted on castor wheels for easy mobility of the dryer as shown in Fig. 1. The tunnel dryer was also fitted with a turbo ventilator to provide the required air flow over the products to be dried. The turbo ventilator depends entirely on the wind effect and the exhaust air from the drying tunnel to operate. The centrifugal force caused by the spinning vanes creates a region of low pressure area which draws in ambient through the inlet door located at the other end of the dryer and exits hot air from the dryer.

*B. Mathematical model*

The differential equations which are solved express a

- Mass conservation equation:

$$\frac{\partial \rho}{\partial t} + \nabla \cdot (\rho U) = 0 \dots \dots \dots (1)$$

- Momentum conservation equation:

$$\frac{\partial(\rho U)}{\partial t} + \nabla \cdot (\rho U \otimes U) = -\nabla p + \nabla \cdot \tau + S_M \dots \dots \dots (2)$$

Where is the stress tensor given by:

$$\tau = \mu \left[ \nabla U + (\nabla U)^T - \frac{2}{3} \delta \nabla \cdot U \right]$$

principle of conservation and are known as continuity, momentum and energy equations. To discretize the governing equations the software ANSYS CFX makes use of an element-based finite volume method, which firstly involves discretizing the spatial domain using a mesh (Figure 2). The mesh is used to construct finite volumes, which are used to conserve relevant quantities such as mass, momentum, and energy. All solution variables and fluid properties are stored at the nodes (mesh vertices). A control volume is constructed around each mesh node and these equations are integrated over each control volume (ANSYS CFX, 2006). [11], [12]

The mass, momentum and energy equations are given in general form as:

- Energy conservation equation:

$$\frac{\partial(\rho h_{tot})}{\partial t} - \frac{\partial p}{\partial t} + \nabla \cdot (\rho U h_{tot}) = \nabla \cdot (\lambda \nabla T) + \nabla \cdot (U \cdot \tau) + U \cdot S_M + S_E \dots \dots \dots (3)$$

To describe turbulence and its effects on flows in the HSB, the standard turbulence model was adopted in this study since it is the most widely applied turbulence model to practical engineering flows as it is robust, economical and provides reasonable accuracy for a wide range of flows.

The turbulence model assumes conservation of turbulence kinetic energy,  $k$ , and its corresponding dissipation rate  $\epsilon$ , through the following relations:

$$\frac{\partial(\rho k)}{\partial t} + \nabla \cdot (\rho U k) = \nabla \cdot \left[ \left( \mu + \frac{\mu_t}{\sigma_k} \right) \nabla k \right] + P_k - \rho \epsilon \dots \dots \dots (4)$$

$$\frac{\partial(\rho \epsilon)}{\partial t} + \nabla \cdot (\rho U \epsilon) = \nabla \cdot \left[ \left( \mu + \frac{\mu_t}{\sigma_\epsilon} \right) \nabla \epsilon \right] + \frac{\epsilon}{k} (C_{\epsilon 1} P_k - C_{\epsilon 2} \rho \epsilon) \dots \dots \dots (5)$$

where:  $C_{\epsilon 1}$ ,  $C_{\epsilon 2}$ ,  $\sigma_k$  and  $\sigma_\epsilon$  are constants given as 1.44, 1.92, 1.0 and 1.3 respectively for most computations.

In (1)-(5);  $\rho$  is the mass density ( $Kg/m^3$ ),  $p$  is the static pressure (Pa),  $U$  is the velocity vector (m/s),  $S_M$  is the momentum source ( $Kg/m^2s^2$ );  $\mu$  is the coefficient of dynamic viscosity ( $Kg/m/s$ ), the superscript  $T$  denotes the transpose of the tensor,  $h_{tot}$  is the specific enthalpy ( $m^2/s^2$ );  $S_E$  is the energy source ( $kg/ms^3$ );  $T$  is the temperature ( $K$ );  $\lambda$  is the thermal conductivity ( $Kgm/s^3/K$ ),  $t$  is the time ( $s$ ),  $P_k$  is the turbulence production due to viscous and buoyancy forces ( $kg/m^3s^3$ ),  $\mu_t$  is the turbulent viscosity ( $kg/m/s$ ),  $\epsilon$  is the turbulence dissipation rate ( $m^2/s^3$ ) and  $k$  is the turbulence kinetic energy per unit mass ( $m^2/s^2$ )

edges and in the outlet air ducts (turbo ventilator stalk) where large gradients exist. The mesh size was decided after carrying out a preliminary grid independency analysis with different mesh resolutions. The mesh in the regions near walls, edges and at the turbo ventilator stack were refined. Fine mesh size with a total number of 9900 elements and 2567 nodes was used to provide more accurate results (Fig. 6).

### C. Simulation Procedure

#### a) Geometry

The geometry of the HSB was created using AutoCAD and then exported to ANSYS Design Modeler software which is specifically designed for the creation and preparation for simulation. The geometry of the HSB consisted of dryer and collector regions (Fig. 5). Each region was modeled as a fluid domain and then interfaced together using an option of domain interface during simulation. The complete model was then exported to the ANSYS ICEM for mesh development. The mesh density was increased in the region around the wall

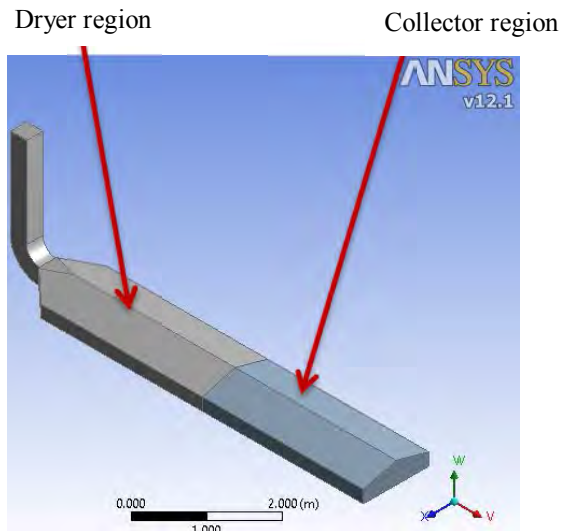

Fig. 1. Geometry of HSB imported to the design modeler

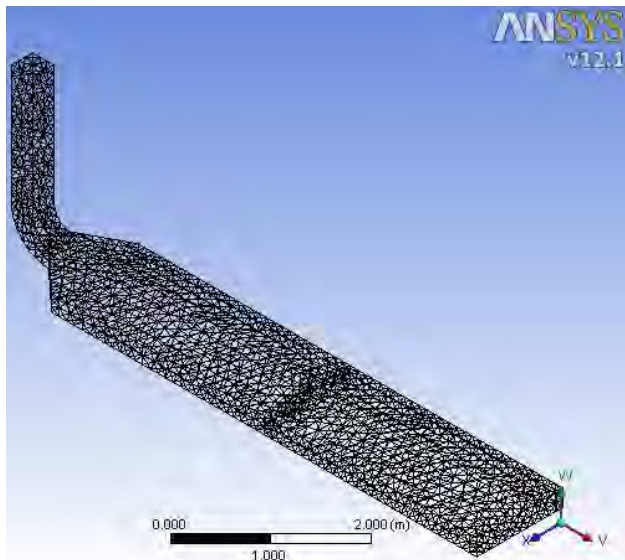

Fig. 2 Mesh from the geometry on ANSYS ICEM CFD

3D simulation analysis was carried out using the commercial CFD package ANSYS CFX 12.1. Model was used to model the effects of turbulence. The physics of the simulation domain was defined in CFX-Pre, the preprocessing module of ANSYS CFX. The two domains were specified as a Non-Buoyant; Stationary Fluid domain with working fluid was assumed as an Ideal gas at 25°C and reference pressure as 1 atm. The ANSYS CFX-Solver module of ANSYS CFX-12.1 was used to obtain the solution of the CFD problem. The solver control parameters were specified in the form of solution scheme and convergence criteria.

Upwind scheme was specified for the solution while for convergence the residual target for RMS values was specified as 10<sup>-6</sup>. The results were analyzed using CFX-post, the post processor module of ANSYS CFX-12.1. The numerical simulation of the dryer was performed in steady state conditions and then results analyzed.

#### b) Boundary conditions

The numerical solution of the above equations involves the use of specific boundary conditions, in particular at surfaces bounding of the domain. The set-up of boundary conditions was defined as follows:

##### Inlet:

The inlet velocity was set at 1 m/s with a turbulent intensity of 5%. The direction of flow was set normal to inlet and temperature of the air assumed to be 70°C.

##### Outlet:

A gauge pressure of 0 Pa was assumed at the outlet of the dryer (exhaust stack). The flow regime at both inlet and outlet boundaries was specified as subsonic.

##### Walls:

At the walls, no slip and smooth wall boundary conditions were used since the velocity near the walls were set at zero. The temperature at the walls was set out considering the measured experimental values and applying a boundary condition of Dirichlet type. At the UV sheet walls, the temperature was set at 55°C and Monte Carlo technique was used for the additional solar radiation modeling with directional radiation flux of 900 W/m<sup>2</sup>. At absorber plate the temperature was also set at 65°C from the experimental data. The other walls were treated with the default boundary conditions of no slip, with smooth and adiabatic walls due to insulation.

For the necessary turbulent quantities at boundaries the CFX default boundary conditions assumed for each turbulence model were employed. The models constants also were assumed as the default values considered in the CFX code.

### III. RESULTS AND DISCUSSIONS

The simulation was done in three dimensions to give the actual and detailed air flow in the dryer, but the results for temperature and velocity profiles were presented in two dimensions since the inlet position is not located at the same plane. The simulation of the dryer was performed without considering the trays and the products to be dried. The model solution in terms of streamlines, contours and vector plots at horizontal and vertical planes in the drying chamber was visualized using ANSYS CFX POST. The criterion of convergence of variables associated with the momentum, heat transfer and turbulence was achieved with 10<sup>-4</sup> in conjunction with a maximum of 10 iterations for each time. The convergence associated with the turbulence model was reached at about 10<sup>-5</sup>, which suggests that the implemented  $k-\epsilon$  model was appropriate. Further, the residuals associated with heat transfer values reached about 10<sup>-6</sup>, which also suggests that the heat transfer problem was well solved.

Fig. 7 and Fig. 8 shows the temperature distribution in the horizontal plane (at the position of the trays) and vertical plane (mid-section of the dryer) in the HSBP using contour plots respectively. A uniform temperature distribution field was observed along the drying chamber especially in the plane where the tray was fitted. The drying air temperature was between 342.1 K and 356.2 K in the drying chamber, whereas temperatures as high as 384.4 K were observed along the side walls of the dryer. It was observed that the temperature profile of exit air was well developed to affect drying; this indicates that the drying chamber length can be increased and more trays added without any significant drop in the temperature. The uniform temperature profile in the drying chamber could be as a result of additional solar radiation through the UV cover sheet.

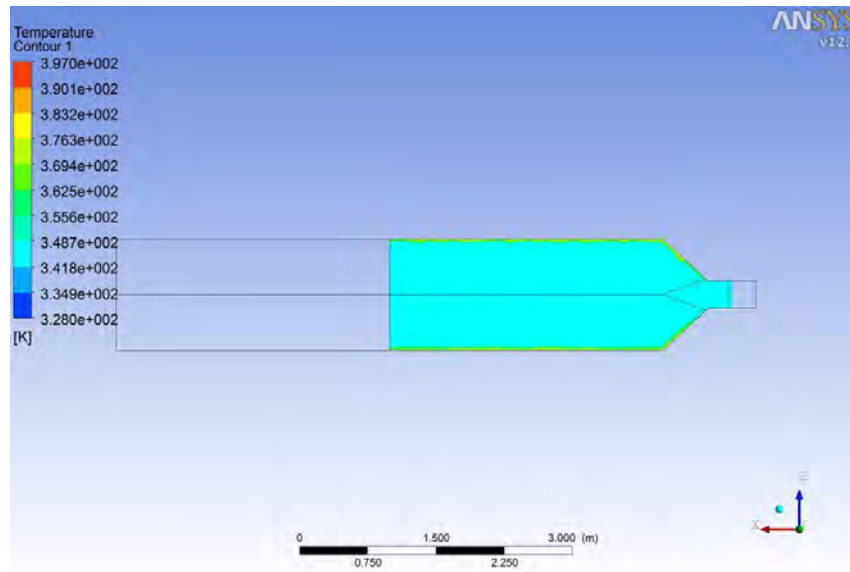

Fig. 3 Temperature distribution in the horizontal plane inside the drying chamber of the HSBD

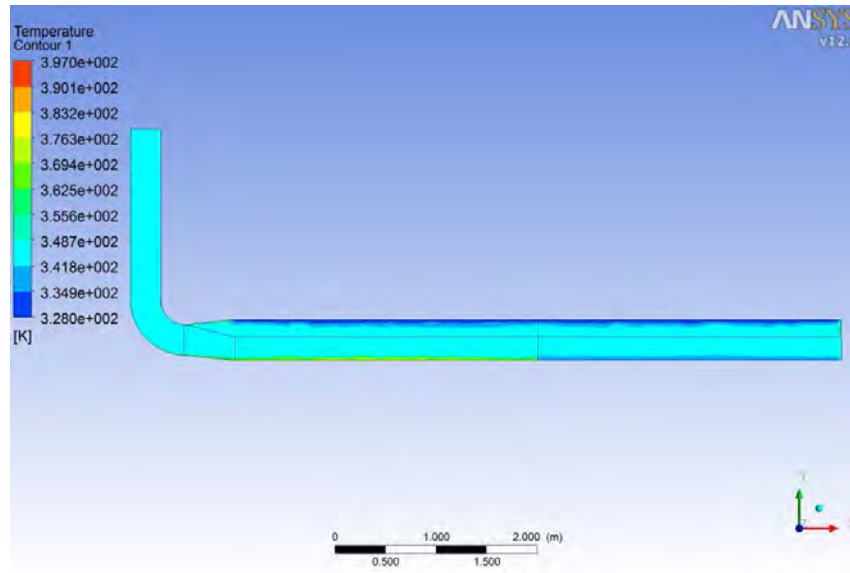

Fig. 4 Temperature distribution in the vertical middle section of the HSBD

Fig. 9 represents the velocity profile of the airflow in the middle section of the HSBD. The maximum air velocity that could be achieved in the drying chamber was 1.55 m/s. The velocity at the inlet as determined by the boundary condition decreased as it entered the solar collector section due to the increased cross sectional area. It was further noted that the velocity was homogeneous at the vertical plane both in the

collector and drying chambers. The highest air flow velocity occurred in the exit section of the dryer after it collided with the curved wall. This was due to the reduction in the cross section area as well as the chimney effect; hence the turbulent flows under the convection heat transfer occurred in the exhaust stack because it was in the high air flow region.



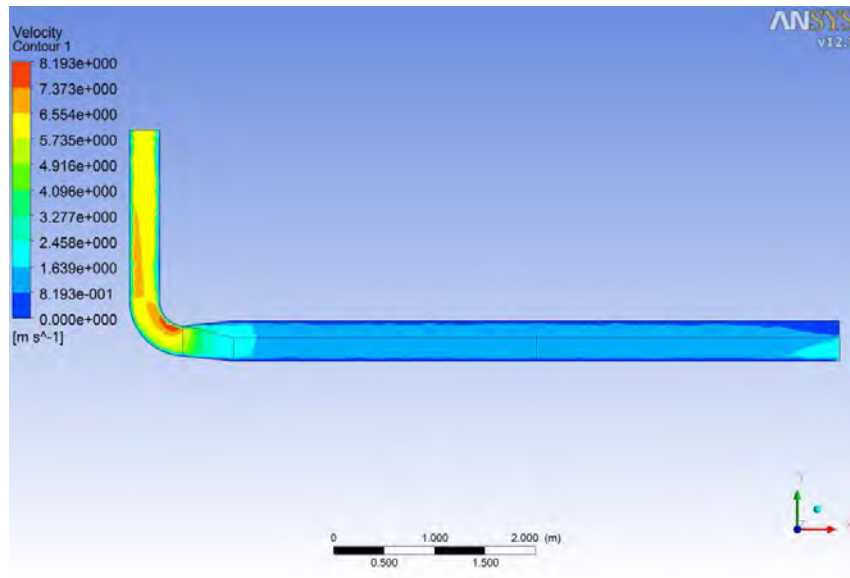

Fig. 5 Velocity profile of airflow in the vertical middle section of the HSBD

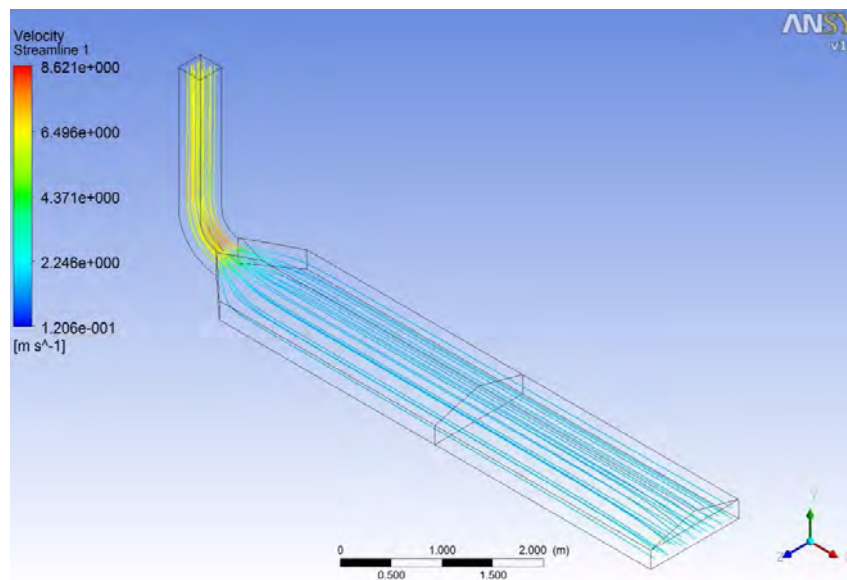

Fig. 6. 3D streamline of airflow inside the HSBD

The simulation result of 3D streamline of airflow in HSBD is as shown in Fig. 10. Streamlines show the movement pattern of the air particles inside the dryer. The streamline pattern inside the dryer showed a smooth and interrupted air

flow from inlet section to the exit section of the HSBD. Based on the streamline colour it can be noted that high air velocity was observed at the air exhaust stack. A uniform airflow was also observed throughout the dryer.

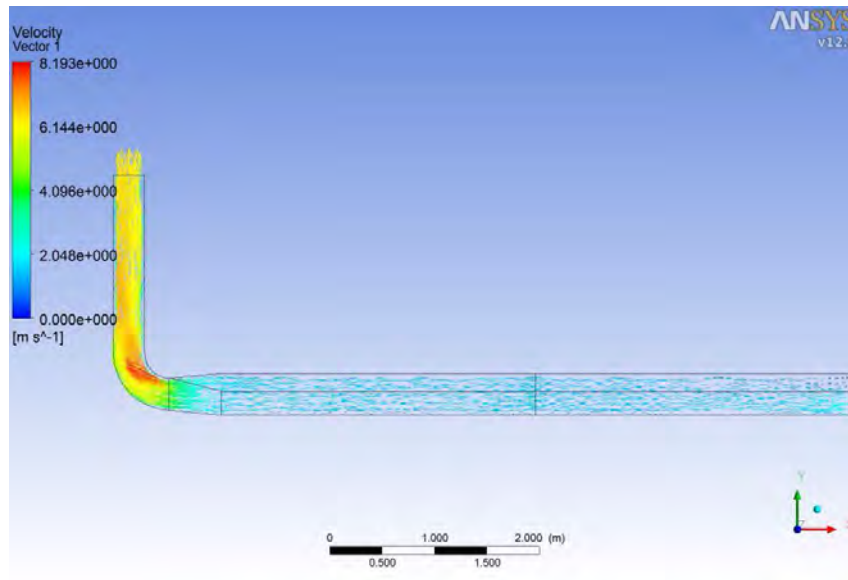

Fig. 7 Velocity vector plot at the vertical middle section of the dryer

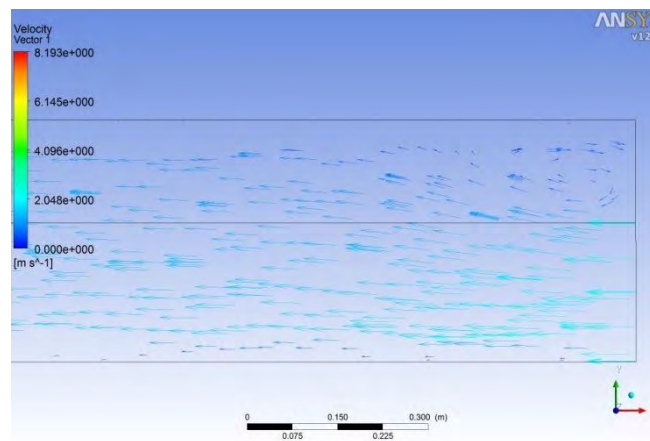

Fig. 8 Velocity vector plot showing recirculation of air in the dryer

Fig. 11 shows the velocity vector plot in the vertical plane at the middle section of the HSB Velocity vector plots are observed to get the clear picture of flow inside the dryer. The velocity vector plot also reflects whether the separation of flow and recirculation occurs or not. The velocity vector plot was nearly uniform in all the chambers but there was small recirculation of air at the inlet towards the top of the dryer (Fig. 12). The velocity vector plot was concentrated in the central region of both the collector and the drying chamber and less concentrated near the walls. This behaviour of the velocity vector plot is desirable for drying purposes.

#### IV. CONCLUSION

Hybrid solar dryers have proven to be successful in drying most agricultural produce. The additional biomass stove- heat exchanger system allows the continuous drying process at night and during wet seasons. This shortens the drying time

and improves the quality of product to be dried. CFD simulation is useful in predicting air velocity and temperature profiles in a drying chamber. The commercial CFD package ANSYS CFX-12.1 was used to predict the three dimensional flow in the HSB. Simulation in 3D provides superior results because it represents the actual problem. The result shows uniform temperature distribution of airflow throughout the dryer. The temperature was maintained almost constant from the collector to drying chamber due to additional heating of air by solar radiation through the UV cover sheet. The velocity of airflow was homogeneous throughout the dryer. This behavior is desirable and suitable for dryer purposes, since it guarantees a high-quality product and homogeneous drying process. The prediction of the airflow inside the dryer can assist to design the most suitable geometric configurations of HSBs and improve the drying process.

## ABBREVIATIONS AND ACRONYMS

CFD	Computational Fluid Dynamics
GI	Galvanized Ironsheet
HSBD	Hybrid Solar Biomass Dryer
UV	Ultra Violet
KIRDI	Kenya Industrial Research and Development Institute

## SYMBOLS

$C_{\varepsilon 1}$	Turbulent model constant
$C_{\varepsilon 2}$	Turbulent model constant
$h_{tot}$	Specific enthalpy [ $m^2 / s^2$ ]
$k$	Turbulence kinetic energy per unit mass [ $m^2 / s^2$ ]
$p$	Static pressure [ $Pa$ ]
$P_k$	Shear production of turbulence [ $Kg / ms^3$ ]
$S_E$	Energy source [ $Kg / m / s^2$ ]
$S_M$	Momentum source [ $Kg / m / s^2$ ]
$t$	Time [ $s$ ]
$T$	Transpose of tensor
$T$	Temperature [ $K$ ]
$U$	Velocity vector [ $m / s$ ]
$\lambda$	Thermal conductivity [ $W / mK$ ]
$\mu$	Coefficient of dynamic viscosity [ $Kg / m / s$ ]
$\mu_t$	Turbulent viscosity [ $Kg / m / s$ ]
$\rho$	Mass density [ $Kg / m^3$ ]
$\sigma_k$	Turbulent model constant for $k$
$\sigma_\varepsilon$	Turbulent model constant for $\varepsilon$
$\tau$	Stress tensor
$\varepsilon$	Turbulence dissipation rate [ $m^2 / s^3$ ]

## ACKNOWLEDGEMENT

The authors would like to thank Kenya Industrial Research and Development Institute (KIRDI) for sponsoring this work.

## REFERENCES

- [1] Prasad, J., Vijay, V.K., Tiwari, G.N. and Sorayan, V.P.S. (2006). Study on performance evaluation of hybrid dryer for turmeric (*Curcuma longa* L.) drying at village scale, *Journal of Food Engineering*, 75: pp. 497-502.
- [2] Barnwal, P. and Tiwari, G.N., \Grape drying by using photovoltaic-thermal (pv/t) greenhouse dryer," *An Experimental Study, Solar Energy*, vol. 82, pp. 1131 {1144, 2008.
- [3] Bena, B. and Fuller, R.J., \Natural convection solar dryer with biomass back-up heater," *Solar Energy*, vol. 72, pp. 75 {82, 2002.
- [4] Analysis of a Hybrid Solar-Electrical Dryer, 2007.
- [5] Weinberg, Z.G., Chen, Y., Finkelman, S., Ashbell, G. and Navarro, S., \The effect of moisture level on high-moisture maize (zea mays l.)

- under hermetic storage conditions in vitro studies," *Journal of Stored Products Research*, vol. 2, pp. 136 {144, 2008.
- [6] Ekechukwu, O.V. and Norton, B., \Review of solar energy drying systems ii: an overview of solar drying technology," *Energy Conversion and Management*, vol. 2, 615 {655, 1999.
- [7] Oyekale, K. O., Daniel, I.O., Ajala, M.O. and Sanni, L.O., \Potential longevity of maize seeds under storage in humid tropical seed stores," *Nature and Science*, vol. 8, 114 {124, 2012.
- [8] Tuite, J. and Foster, G.H., \Control of storage diseases of grain," *Annual Review of Phytopathology*, vol. 1, pp. 343 {366, 1979.
- [9] Rashad A. S., Kurt A. R., Carl J. B., Effects of Deterioration Parameters on Storage of Maize, *Agricultural and Bio systems Engineering Presentations, Posters and Proceedings*.
- [10] Aukah, J., Kerich, D. and Ogola, J. (2013). Development of solar biomass hybrid tunnel dryer for drying grains. In: *Trends and Opportunities in the Production, Processing and Consumption of Staple Food Crops in Kenya*. (Eds). C. Onyango, G. Unbehend and M. Lindhauer. Chapter 11, pp 111-129. . ISBN: 978-3-944331-17-1, TUD Press, Verlag der Wissenschaften GmbH, Dresden, Germany.
- [11] Kiranoudis, C.T., Karathanos, V.T. and Markatos, N.C., \Computational uid dy-namics of industrial batch dryers of fruits," *Drying Technology*, vol. 17(1&2), pp. 1 {25, 1999.
- [12] ANSYS - CFX Solver theory guide."

# Tool Wear, Wear Mechanism and Dimensional Accuracy in Machining Al<sub>2</sub>124SiCp MMC using CBN and PCD Tools

Muguthu Joseph Njuguna<sup>1\*</sup> and Dong Gao<sup>2</sup>

**Abstract**— The paper presents turning of Al<sub>2</sub>124SiCp (45%wt) Particulate Metal Matrix Composite using PCD, CBN-coated and CBN-uncoated tools. Tool wear, wear mechanism, surface roughness, and dimensional accuracy are investigated. Machining was performed at a feed rate of 8.3 mm/min with machining depth as 0.1, 0.2 and 0.3mm, cutting speeds of 40, 60, 80 and 100 m/min, using High Precision Lathe Machine Model No: CG6125C having span 250 and length 500 mm respectively. Results reveal that Tool wear mechanism observed while using CBN-uncoated and CBN-coated were abrasion, adhesion, chipping and fracture. While using PCD tool wear mechanisms observed were abrasion, adhesion and chipping. On the type of wear, for PCD tool flank and crater wear were observed while for CBN tools flank wear was observed. PCD tool produced the best surface finish followed by CBN-coated while CBN-uncoated tool produced the worst surface finish. On dimensional accuracy it was observed that PCD has the lowest diameter error followed by CBN-coated and lastly CBN-uncoated. It is concluded that in machining Al<sub>2</sub>124SiCp (45%wt) Particulate Metal Matrix Composite PCD tools are the best followed by CBN-coated and finally CBN-uncoated tools.

**Keywords**— Tool Wear; Wear Mechanism; Surface Roughness; Dimensional Accuracy; Al<sub>2</sub>124SiCp MMC

## I. INTRODUCTION

IN recent years there has been an increase in the amount of composite materials whose matrix is metal in substituting monolithic materials in various uses as vehicle and sports related industry [1]. Metal Matrix Composites (MMCs) are endowed with superior qualities which include reduced weight and higher strength, elastic modulus, excellent wear resistance to abrasion [2]. However their full potential has not been realized yet over monolithic alloys. Key reason to this setback is their machinability which still poses a significant setback [3; 4]. Because of irregular nature of abrasive reinforcements of MMCs, their machining poses a challenge [5]. Presence of reinforcement phase causes rapid abrasive tool wear [5; 6]. Metal Matrix Composite parts are cast to close tolerances and brought to final dimensional requirements by machining [5; 7].

Cemented carbide tools, widely used in metal cutting wear

rapidly while cutting particulate MMCs because of hard SiC particles present and surface produced is undesirable for specialized engineering work [5; 8]. In turning of MMCs poor surface is produced when coolant is used coupled with increased wear of the tool [6]. Through various researches diamond related cutting tools have been identified as the most effective and most preferred in machining Particulate MMCs [5].

Tool wear and breakage have been an issue with cutting tools since they were created. Tool wear weakens the cutting tool, increases the forces used in cutting and causes a lack of consistency in material removal. Parts and time lost to scrap and rework from tool wear are costly to manufacturing companies [9; 10]. Wear of cutting tools has been discussed by various authors who agree in principle that cutting tool wear constitutes abrasive, adhesive, diffusion, fracture and chipping mechanism of wear [9; 11].

Muthukrishnan N. et al [4] conducted experimental investigation involving turning of MMC (A356/SiC/10p). The researchers used PCD tool of grade 1500 and assessed surface finish, power consumption and tool wear.

Rajesh K. B. et al [12], studied effects of SiCp reinforcement to machining Al 7075 SiC (10%wt). The researchers assessed tool wear and surface finish in relation to feed, machining speed, and cut depth. Alakesh M. and Bhattacharayya B, [6] tested the ability to turn Al/SiCp (15%vol) using uncoated Rhombic carbide tool. The researchers observed that feed rate, turning speed and depth of cut had similar effect on part finish.

Dimensional accuracy in machining remains an important component in assessing quality related to a machined part. It can be resolved by measurements related to size and geometric or shape properties such as straightness, angularity, cylindricity and circularity. During machining, components actual size dimensions vary from those in design. This variation is referred to as dimensional error [13; 14]. Surface quality can be referred to as the condition of the machined surface which is generally explained as haphazard departure of variation from the nominal of a recurring surface. Surface texture is defined through the elements of roughness and waviness [13].

From literature involving turning particulate MMC, chips,

J. Muguthu, Department of Mechanical Engineering, Kenyatta University (254-710518439; e-mail: muguthu@yahoo.com, muguthu@gmail.com).  
Dong Gao, Graduate School, Harbin Institute of Technology, China

amount of reinforcement together with matrix material performance have an impact on the machining process. It is further observed that no literature is presented on machining Al<sub>2</sub>124SiCp (45%wt) PMMC using PCD, CBN-uncoated and CBN-coated to evaluate surface finish, wear mechanism and dimensional accuracy. This paper therefore seeks to assess tool wear, wear mechanism, surface roughness and dimensional accuracy while machining Al<sub>2</sub>124SiCp (45%wt) PMMC using PCD, CBN-coated and CBN-uncoated tools.

## II. EXPERIMENTAL SET-UP

### A. Component Design

Round bar of Al<sub>2</sub>124SiCp (45%wt) MMC 36.0 mm diameter and 78 mm long was used for this study. The reinforcement consisted of particulate SiC of grain size 5 to 8  $\mu$ m diameter. The amount of SiC in the MMC constituted (45% wt).

### B. Cutting Tools

Triangular shaped cutting tools consisting of CBN-coated, CBN-uncoated and PCD manufactured by Sumitomo Electric (Japan) were used. They consist of CBN-coated grade BNC 100 having relief angle of 00 and rake angle 00, CBN-uncoated of grade BN 700 having relief angle 00 and rake angle 00 and finally PCD of grade DA2200 having relief angle of 50 and rake angle of 100. The tools were mounted on PTTNR2525-33 tool holder.

### C. Machining and Measurement Procedure

The machining of the particulate MMC was carried out at four machining speeds of 40, 60, 80, and 100 m/min using High Precision Lathe Machine Model No: CG6125C with a span radius 250 mm and length 500 mm. Feed rate was set at 8.3 mm/min and cut depths used were 0.1, 0.2, and 0.3 mm. No coolant was used during the cutting test. Cutting force was measured using three-component tool force dynamometer which was mounted on the cross slide of the high precision lathe machine. During the experiment TR200 portable roughness equipment manufactured by Time Group Inc Australia and Form Talysurf PGI 1240 manufactured by Taylor Hobson Inc (USA) were used to measure work-piece surface finish. The worn tool tips were observed under CCD camera and the flank wear was measured through use of integrated scale. Diameter error was measured using API tracker 3 Ultra-Portable Laser tracking System Model No: Tripod SC11032 which was placed 2.5 m from the work-piece.

## III. RESULTS AND DISCUSSION

### A. Tool Wear

During machining Al<sub>2</sub>124SiCp (45%wt) MMC under current conditions dominant wear mode physically observed was flank wear although negligible crater wear was also observed. Figure 1 shows effect of machining speed to tool flank wear of CBN-uncoated, CBN-coated and PCD tools while cutting Al<sub>2</sub>124SiCp (45%wt) MMC. At varying cutting speed and constant feed at depth of cut 0.1mm, 0.2mm and 0.3mm the maximum flank wear is as follows. At 0.1mm depth of cut, CBN-uncoated has the highest flank wear of 0.22mm followed by CBN-coated 0.15mm and finally PCD 0.01mm. At 0.2 mm depth of cut, CBN-uncoated has highest the flank wear of 0.28mm followed by CBN-coated 0.24mm and finally PCD 0.014mm. While at 0.3mm depth of cut maximum flank wear for the CBN-uncoated is 0.35mm, CBN-coated 0.31mm and PCD 0.016mm. It is observed that CBN-uncoated has the highest wear at all cutting speeds and corresponding depths of cut. Flank wear increased gradually for PCD tool as the machining speed increased as well as depth of cut at constant feed rate of 8.3 mm/min, however for CBN-uncoated and CBN-coated tools flank wear increase is not gradual but irregular.

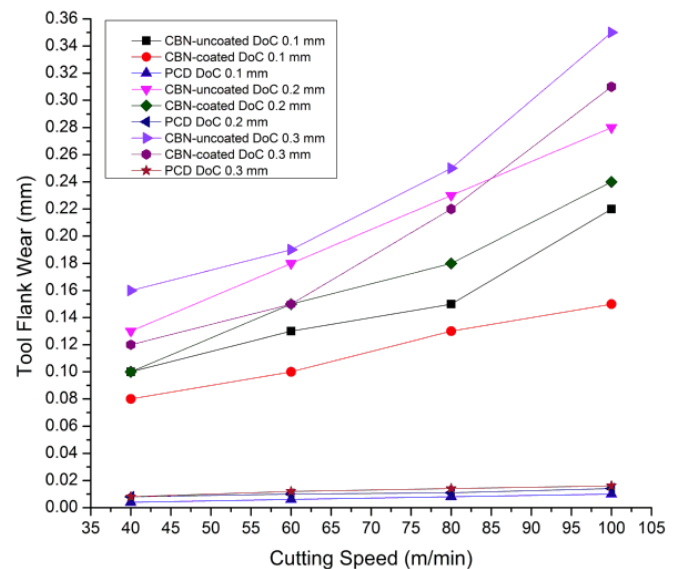

Fig. 1. Tool flank wear

The dominant wear mechanism for the tools is abrasion [5; 15], adhesion and chipping, however fracture is also observed. Figures 2, 3 and 4 show the various wear patterns on the three tools used in the experiment. From the images it can be construed that the dominant wear mechanism among all the tools is abrasion wear caused by hard SiC particles. Abrasion wear is commonly characterized by the presence of grooves parallel to the cutting direction on tool flank face [4]. Though CCD images of the tools were taken from the cutting tool rake, progressive wear of the cutting edge in this case is an indication of abrasive wear. CBN-uncoated tools showed

excessive flank wear at the same cutting time as compared to CBN-coated and PCD tools. Abrasive wear is evident in all the tools though it's more prevalent among CBN-uncoated and CBN-coated tools. As cutting speed increases, both the length and width of flank wear increases figure 2 revealed by the amount of flank wear. CBN-coated and CBN-uncoated tools show a relatively stable built up edge (BUE) figure 2 and 3 which enabled the tool to have longer life. However the BUE has an effect on the surface quality as some of the matrix material is deposited of the work surface hence lowering surface quality. It also causes adhesion wear of the tool as matrix material pulls out some tool material. Fracture wear of the tool is observed figure 3 (e) where the coating is fast worn out during machining. The presence of high percentage of hard SiC particles contribute to fast wear of the coating of CBN-coated. The worn tools reveal BUE on the cutting edge as shiny aluminum matrix material. Due to excessive tool wear for both CBN-coated and CBN-uncoated tools, cutting force is seen to increase as cutting progresses, however for PCD tool there no significant change in cutting force as machining progresses due to low wear effects.

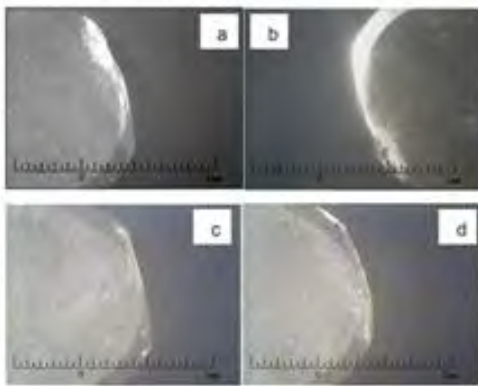

Fig.2. Wear on CBN-uncoated

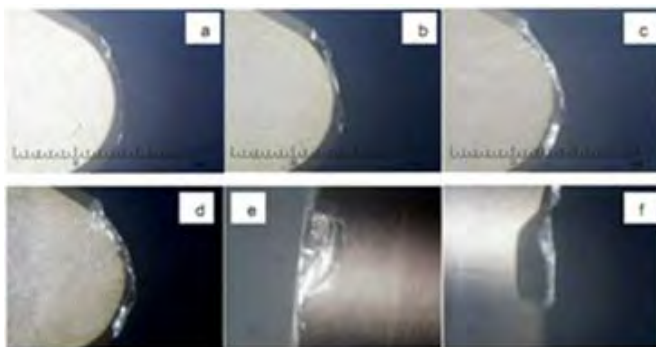

Fig.2. Wear on CBN-coated

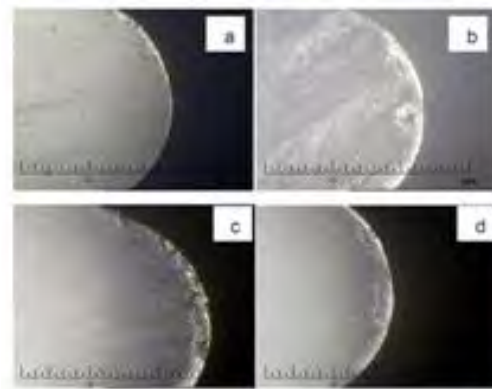

Fig.2. Wear on PCD

For PCD tool figure4 wear is quite minimal and the tool retains the cutting edge for a long time as compared to CBN-uncoated and CBN-coated tools. The mode of wear observed is abrasion and chipping of the cutting edge where chipping is shown by worn cutting edge in form of a rugged edge in the nose region. PCD tool wears through abrasion by the interaction of SiC and diamond particles [3]. Hardness of diamond is higher than that of SiC, therefore abrasion wear may be due to mechanical failure but not cutting at micro level [12]. This can be effective in two ways; two-body abrasion and three-body abrasion [4]. Rake face of PCD tool also encountered wear though minimal in form of crater wear Figure 4(a, b). Chipping is also observed in PCD tool which shows the worn machining edge which appears as rugged edge figure 4 (a, c). The impact between hard SiC particles and tool edge cause chipping wear of PCD tool [3]. Examination of the PCD tool revealed a relatively stable BUE at low cutting speed which is seen as a shiny part on the cutting edge. This cause adhesive wear of the PCD tool as matrix material pulls out some tool material [16]. However as cutting speed increased BUE disappeared with only traces of embedded matrix material. Comparing CBN-uncoated, CBN-coated and PCD tools it is observed PCD suffers lowest wear in the machining process and retains its cutting edge for a long time.

### B. Surface Roughness

Figure 5 shows the effect of turning speed and depth of cut on surface finish while dry turning Al<sub>2</sub>O<sub>3</sub>/SiCp (45%wt) MMC using CBN-uncoated, CBN-coated and PCD tools. Cutting parameters considered included feed rate of 8.3 mm/min cut depth of 0.1 mm, 0.2 mm and 0.3 mm while cutting speed was varied from 40 to 100 m/min. From figure 5 it is seen that the value Ra for surface varies with machining speed. For CBN-uncoated and CBN-coated the value Ra increases with increase in machining speed. This can be attributed to rapid wear of CBN tools and the effect of BUE where matrix material get embedded on to the work surface hence lowering surface quality. Comparing CBN-uncoated and CBN-coated it is observed that CBN-coated

produced better surface finish than that of CBN-uncoated. However for PCD tool, the value Ra for surface is observed to reduce when machining speed is increased. This agrees with observations made by Muthukrishnan N. et al [5] in machining of PMMCs using PCD tools. It can be concluded that machining speed is important to ensure quality surface finish while using PCD tools. While turning Al<sub>2</sub>124SiCp (45%wt) at low machining speed BUE forms which lead to poor surface finish. When machining speed is increased BUE disappears and a corresponding decrease in chip fracture thus improving finish. For all the tools when depth of cut is increased, surface roughness Ra also increases. PCD tools performed better than CBN tools removing more material than CBN tools and also preserved surface of the work-piece during the entire cutting process.

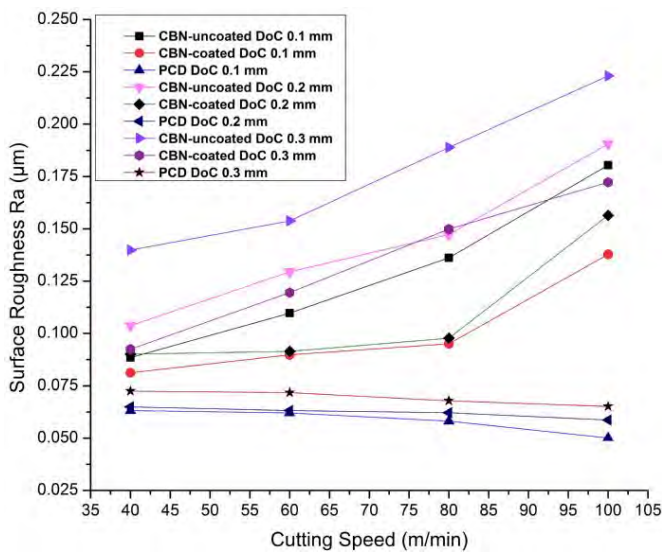

Fig. 5. Surface Roughness

### C. Dimensional Accuracy

Generally the quality of the machined components may be evaluated by important characteristics as dimensional accuracy as well as surface finish. Dimensional accuracy of machined components is established through measurement of size geometrical or shape properties such as straightness, angularity, cylindricity and circularity. However in most cases machined components actual size dimension differs from the designed size dimension [17]. This difference is known as size error and is often employed in verifying level of size dimension accuracy. In this experiment diameter error was assessed with reference to designed size as compared to machined size. Diameter error is chosen to assess dimensional accuracy in turning Al<sub>2</sub>124SiCp (45%wt) MMC. Diameter error refers to the deviation from designed size to the actual size. This quality aspect is vital of cylindrical parts required in fitting purposes [13].

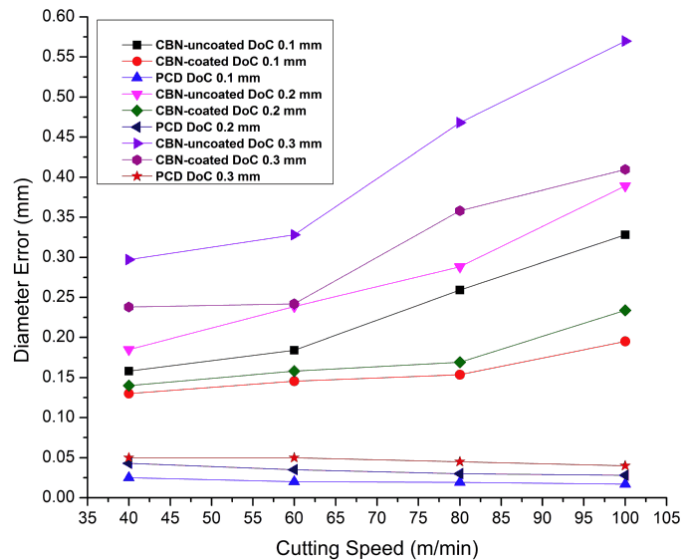

Fig. 6. Diameter Error

The effect of cutting speed and depth of cut on diameter error in dry turning Al<sub>2</sub>124SiCp (45%wt) MMC using CBN-uncoated, CBN-coated and PCD tools is shown in figure 6. Cutting parameters considered included feed rate of 8.3 mm/min, 0.1 mm, 0.2 mm and 0.3 mm depth of cut while cutting speed was varied from 40 to 100 m/min. It is observed the general trend in diameter error increase with increasing cutting speed for CBN-uncoated and CBN-coated tools at the considered depths of cut. This increase in diameter error may be due to rapid wear of CBN tools causing decrease in depth of cut as cutting progresses. Further this may be due to the effect of BUE where matrix material get embedded on to the work surface hence lowering surface finish hence dimensional quality. Comparing CBN-uncoated and CBN-coated tools it is observed that CBN-coated tool produced a better dimensional quality than that of CBN-uncoated tool. It is observed that for PCD tool, diameter error is quite negligible and decreased as the cutting speed changed at the selected depth of cut. This can be attributed to wear resistance of PCD tools as well as reduction in BUE at high cutting speeds. At low cutting speed BUE causes matrix material to be deposited on to the work surface hence affecting diameter. At high cutting speeds PCD tools produce better surface finish which is attributed to better dimensional quality. Thus cutting speed plays a crucial role in deciding dimensional accuracy while PCD tools are used. Comparing all the tools, increasing depth of cut causes a corresponding increase in diameter error. PCD tools performed better than CBN tools and maintained a good dimensional quality on the work-piece throughout the cutting process.

### IV. CONCLUSIONS

Tool wear and wear mechanism of CBN-uncoated, CBN-coated and PCD tools in turning Al<sub>2</sub>124SiCp (45%wt) Particulate Metal Matrix Composites were investigated.

Surface roughness and Dimensional accuracy were also investigated.

Tool wear mechanism observed while turning Al<sub>2</sub>O<sub>3</sub>/SiCp (45%wt) PMMCs using CBN-uncoated and CBN-coated were abrasion, adhesion, chipping and fracture.

Tool wear mechanism observed while turning Al<sub>2</sub>O<sub>3</sub>/SiCp (45%wt) PMMCs using PCD were abrasion, adhesion and chipping.

Dominant type of wear observed for PCD tool were flank and crater wear while for CBN tools were flank wear.

PCD tool produced the best surface finish followed by CBN-coated while CBN-uncoated tool produced the worst surface finish.

On dimensional accuracy it was observed that PCD has the lowest diameter error followed by CBN-coated and lastly CBN-uncoated.

#### REFERENCES

- [1] M. Kok, Modelling the Effect of Surface Roughness Factors in the Machining of 2024Al/Al<sub>2</sub>O<sub>3</sub> Particle Composites Based on Orthogonal Arrays, *Int J Adv Manuf Technol.* 55 (2011) 911-920.
- [2] A.Sajjad, J. Roohollah, N. Behzad and R. T. Mohammad, Manufacturing of High-Performance Al<sub>3</sub>Si/SiCp Composite by CAR Process, *Mater Manuf Process* 26 (2011) 902-907.
- [3] N. Muthukrishnan, M. Murugan and K. P. Rao, Machinability issues in turning of Al/SiC(10p) Metal Matrix Composite. *Int J Adv Manuf Technol.* 39 (2008) 211-218.
- [4] I. Ciftci, Cutting Tool Wear Mechanism when Machining Particulate Reinforced MMCs, *Technology.* (2009).
- [5] N. Muthukrishnan, M. Murugan, and R. K. Prahlada, An investigation on the machinability of Al-SiC metal matrix composites using ped inserts. *Int J Adv Manuf Technol.* 38 (2007) 447-454.
- [6] M. Alakesh and B. Bhattacharayya, Influence of machining parameters on the machinability of particulate reinforced Al/SiC-MMC, *Int J Adv Manuf Technol.* 25 (2005) 850-856.
- [7] T. Rajmohan and K. Palanikumar, Experimental Investigation and Analysis of Thrust Force in Drilling Hybrid Metal Matrix Composites by coated Carbide Drills, *Mater Manuf Process.* 26 (2011)961-968.
- [8] M. Dogra, et al., Finish Hard Turning of Continuous and Interrupted Surfaces with Cubic Boron Nitride (CBN) and Coated Carbide Tools, *Mater Manuf Process.* 27 (2012) 523-530.
- [9] R. Y. Patil, Cutting Tool Wear Mechanism, *J Sci Engg & Tech Mgt.* (2010).
- [10] S. Ercan, A. Kubilay, and C. Adem, Tool Wear Mechanism in Interrupted Cutting Conditions. *Mater Manuf Process.* 24 (2009) 476-483.
- [11] W. Xiaoyu, Design of Neural Network Based Estimator for Tool Wear Modelling in Hard Turning, *J Intell Manuf.* 19 (2008) 383-396.
- [12] K. B. Rajesh, K. Sudhir, and S. Das. Effect of machining parameters on surface roughness and tool wear for 7075 Al alloy SiC composite, *Int J Adv Manuf Technol.* 50 (2010) 459-469.
- [13] N. H. Rafai, and M. N. Islam, An Investigation into Dimensional Accuracy and Surface Finish Achievable in Dry Turnin, *Mach Sci Technol.* 13 (2009) 571-589.
- [14] N. H. Rafai, and M. N. Islam, Comparison of Dry Turning and Flood Turning in Terms of Dimensional Accuracy and Surface Finish of Turned Parts, *Lecture Notes in Electrical Engineering.* (2011).
- [15] R. Ramanujan, N. Muthukrishnan, and R. Raju, Optimization of Cutting Parameters for Turning Al-SiC(10%) MMC Using ANOVA and Grey Relational Analysis, *Int J Prec Engg Manuf.* 12 (2011) 651-656.
- [16] D. Guojun, Z. Haijun, Z. Ming, Z. Yuanjing, Experimental Investigation on Ultrasonic Vibration Assisted Turning of Sicp/Al Composites, *Mater Manuf Process.* (2012).
- [17] ASME. ASME Y14.5-2009, Dimensioning and Tolerancing, ASME. (2009).



# An Evaluation of Maintenance Practices in Kenya: Some preliminary results

A.K. Muchiri<sup>1</sup>, B.W. Ikua<sup>1</sup>, P.N. Muchiri<sup>2</sup>, P.K. Irungu<sup>2</sup> and K. Kibicho<sup>1</sup>

*Abstract*—Over time, the definition of maintenance has evolved from activities meant to keep equipment in an operable condition, to a set of activities required to keep the means of production in the desired operating conditions or to restore them to this condition. Further, all those systematic activities geared towards the actual execution and improvement of maintenance are referred to as Maintenance practices. There is a general assumption that maintenance practices in the developing world are below standard, when compared to what happens in the developed world. However, this is not a fact that has been determined empirically, but rather a perception. This paper presents the results of an assessment of maintenance practices in Kenyan industries, using a maintenance practices evaluation tool. The analysis provides a critical overview of the current status of maintenance practices and also how these maintenance practices compare with the best practices globally. The research was carried out through a survey, using a questionnaire developed to establish the maintenance practices in a number of Kenyan companies. The survey clustered into different categories, namely, service, power generation, food manufacturing and processing, agro/chemical, metal processing, motor vehicle assemblers, transport, maintenance and construction industries. The responses from the survey were analyzed using the three aspects of maintenance practices, namely, technical, managerial and human aspects. For each of these aspects, an evaluation index was developed and calculated. Subsequently, the general evaluation index was determined. This index showed that Kenyan companies are at the managed level of maintenance practices. At this level, the processes are partially planned and performance depends on the operators' experience and competence.

It is recommended that the companies aim at improving the index to the highest level, namely the optimizing stage.

*Keywords*—Maintenance practices, Evaluation criteria, Maintenance in Kenya

## I. INTRODUCTION

**T**HE core function of maintenance should be to preserve components and equipment so that they can perform their desired functions. This calls for good policies and strategies in the company. Also, due to the increasing demand on increased productivity, quality and availability, machines have become more complex and capital intensive [1]. Thus, there is need for improved maintenance techniques using advanced sophisticated equipments to diagnose and even repair the machines. Also, the manpower must be trained so that they can be able to use the advanced monitoring and diagnostic equipment.

In view of the above, a good maintenance policy is a necessity in the work environment for increasing the availability of

the equipment. Unfortunately, most individuals or companies perform maintenance after an emergencies or breakdown, but mostly because it has to be done. In an effort to increase the profit and maximize availability of the equipment, maintenance is only done when the operators are not present e.g. over the weekends or on public holidays. This leads to unexpected breakdowns or poor performance because the operators do not have the actual performance history of the machine.

Maintenance practices have been defined in literature as the systematic activities that are geared towards the execution and improvement of maintenance. The two perspectives of maintenance practices are maintenance execution and maintenance improvement [2]. A company must adopt good maintenance practices in order to achieve its goals of production.

Maintenance engineering is a new area of research in Kenya. Previously, maintenance was handled as a topic in the various engineering courses. This has led to local graduates being employed without a firm grounding in maintenance. This has had a significant contribution to how maintenance is handled. Unless there is failure, no effort is made to check the probabilities and effects of a failure occurring. This is an undesirable approach to maintenance.

## II. PROBLEM STATEMENT

The world has become a global market today. Thus, for the local companies to compete with others, their production costs must be kept low. One of the major areas in reduction of cost is effective maintenance. There is, therefore, a need to establish how maintenance is practiced in Kenya. Also, an area of interest is how the country compares with other nations in terms of maintenance practices.

This paper aims at establishing the maintenance practices used in Kenya, and evaluating these practices with the aim of determining how the country compares with developed economies.

### A. Significance Of The Research

This research will provides an in depth analysis of the local maintenance practices and the level of these practices. Also, an evaluation of these practices has been made with the best practices globally. This knowledge gap lacks in the former research work done in the country.

## III. EVALUATING MAINTENANCE PRACTICES

Over the years, the concepts of maintenance have undergone many major developments. Thus, several maintenance

<sup>1</sup>A.K. Muchiri, Department of Mechanical Engineering, JKUAT (phone: +254722217209; fax: +2546752711; e-mail: muchiri@eng.jkuat.ac.ke).

<sup>2</sup>P.K. Irungu, Department of Mechanical Engineering, DeKUT (e-mail: irungupk@gmail.com).

approaches, strategies, policies, methodologies and philosophies have been implemented. These concepts are normally developed with a managerial perspective, and little is known about the execution perspective, i.e. what actually is done on the shop floor.

A lot of literature has been written in the field of maintenance. Macchi and Fumagalli [3] evaluated maintenance in terms of managerial, organizational and technological capabilities. They further developed the five levels of maintenance maturity. However, their main focus was on maintenance management. Areas not covered in their study included maintenance practices with regard to activities that happen on the shop floor. Tahboub [4] investigated maintenance practices and the problems faced by Jordanian industries. The key finding of his research was that most industries had maintenance departments but did not allocate sufficient budgets to them. This research did not assess maintenance practices.

There is also a lot of literature on maintenance modeling and optimization, but for evaluation purposes there is a gap when it comes to the observable actions and practices in the manufacturing industries.

This research intends to establish the maintenance practices in Kenyan industries, and to evaluate them against a pre-defined criteria.

#### IV. METHODOLOGY

This paper forms part of a larger research on optimization of maintenance practices in the developing world, and specifically in Kenya. The main objective of this paper is to assess the level of maintenance practices in the Kenyan manufacturing industries. For this purpose, a theoretical framework for assessment of maintenance was used. A survey was conducted in several companies as a sample of the population. The results of this survey are presented later in this paper.

##### A. The Assessment Framework

Muchiri et al [2] proposed a five-level framework for classifying maintenance practices.

The framework on Table I suggests that an organization at level 1 has poor maintenance practices, and one at level 5 utilizes best maintenance practices. However, it is possible for an organization at this highest level to utilize all strong practices from the levels below. It is also possible that an organization at a lower level employs some of the practices associated with higher levels [2].

##### B. Data Collection

A quantitative approach was used to achieve the objectives of the research. A survey questionnaire was developed to assist the researcher to collect the quantitative data regarding the maintenance level, the operations of the maintenance department, the workforce in the department, the tools and equipment used etc. The questionnaire had 38 questions, subdivided into five sections, namely: introduction, the technical evaluation, the managerial evaluation, the human related evaluation and finally comments of the interviewee. Direct

TABLE I  
THE FIVE-LEVEL FRAMEWORK FOR CLASSIFYING MAINTENANCE PRACTICES [2]

Stage	Classification	Description
Level 1	Basic practices	Practices employed tend to be unplanned and unpredictable. Performance of tasks is very subjective to the person assigned.
Level 2	Repeatable practices	Practices associated with repetitive maintenance practices. Partial planning of processes, and practices related to process monitoring is utilized.
Level 3	Proactive practices	Practices associated with planning and implementation according to organizational objectives. Use of quantitative analysis to plan and define maintenance tasks
Level 4	Managed practices	Practices related to managing and controlling maintenance, by planning based on feedback data from various maintenance processes.
Level 5	Optimum practices	Practices related to continuous improvement of maintenance and quality control, failure analysis, defect analysis, future improvements, Design Out Maintenance (DOM) practices also utilized. Testing of new maintenance methods and techniques may also feature.

interviews with the maintenance engineer or personnel was used to collect the opinions of the interviewee and their explanations on information which may not be clear from the data collected.

This approach has been used by a number of researchers in the field of maintenance engineering [4]–[9].

The questions were formulated to bring clarity on elements of the maintenance practices. The analysis of the questions answered the following:

- 1) The maintenance activities performed in the industry under investigation.
- 2) The details of the maintenance programs pursued.
- 3) The extent of the application of maintenance concepts.
- 4) The level of improvement on the maintenance concepts.
- 5) The cost elements of maintenance and budgetary provisions.
- 6) The performance measurement system used.

#### V. RESULTS

A total of 78 companies were approached to participate in the survey. 50 out of 78 companies responded to the survey. This represents a 64.1 % response, which is sufficient to provide a critical analysis of the maintenance practices being employed in the industries. The analysis of the responses is as shown in Table II.

The results of the survey were analyzed based on the three aspects of maintenance practices, i.e. technical, managerial and human aspects [2]. The evaluation index (E.I) as per an individual aspect was then calculated using the formula 1

$$E.I. = \frac{\text{question score} \times \text{weighting} \times \text{number of responses}}{\text{total number of questions}} \quad (1)$$

TABLE II  
RESPONSE PER CATEGORY OF INDUSTRY

Category of industry	Number of questionnaires sent	Responses
Service industry	8	50
Power generation plants	5	80
Food manufacturing industries	35	79.1
Metal processing industries	5	80
Agro/Chemical industries	3	66.7
Motor vehicle assemblers	4	50
Transport industries	4	100
Maintenance industries	8	75
Construction industries	6	66.7
<b>Total</b>	<b>78</b>	<b>64.1</b>

Thereafter, a combined General Evaluation Index (G.E.I) was determined, as an arithmetic average of the three aspects evaluation indexes.

#### A. Technical Aspects

The above aspects were covered by questions 7 to 20 of the questionnaire. The cumulative responses totaled 699. A summary of the responses is presented on Table III.

TABLE III  
RESPONSES ON TECHNICAL ASPECTS

QUESTION NUMBER	NUMBER OF RESPONSES PER MAINTENANCE LEVEL					No. of responses
	L1	L2	L3	L4	L5	
7	9	16	5	13	7	50
8	8	18	8	9	7	50
9	9	15	3	16	7	50
10	8	15	12	5	10	50
11	5	19	3	20	3	50
12	13	3	15	5	14	50
13	9	10	12	7	12	50
14	2	6	9	16	17	50
15	4	10	12	7	17	50
16	3	4	7	18	18	50
17	16	9	9	7	9	50
18	9	15	15	1	9	49
19	5	2	25	8	10	50
20	0	2	14	11	23	50
<b>TOTAL</b>	<b>100</b>	<b>144</b>	<b>149</b>	<b>143</b>	<b>163</b>	<b>699</b>

1) *The Technical Evaluation Index (T.E.I)*: The T.E.I was calculated using equation 1, and found to be **2.398**. The following rules can be defined with regard to determining the Level (L) for a given aspect:

$$\begin{aligned}
 & \text{if } 1 \leq EI \leq 2 \text{ then } L = 1 \\
 & \quad 2 \leq EI \leq 3 \text{ then } L = 2 \\
 & \quad 3 \leq EI \leq 4 \text{ then } L = 3 \\
 & \quad 4 \leq EI \leq 5 \text{ then } L = 4 \\
 & \text{otherwise } L = 5
 \end{aligned} \tag{2}$$

Based on equation 2, the Level for technical aspects will be **2**.

According to Table I, the Technical aspects of maintenance practices are at the *managed level*.

Some deductions from the responses are as follows:

- (i) Maintenance and repair activities generally follow the OEM maintenance specifications, with very little innovation or modification.

- (ii) The re-ordering of spare parts is mainly done using the minimum stock levels based on experience, and very little automation to such a process is applied
- (iii) Job cards are used, and repairs are monitored based on time.
- (iv) There is a high dependency on highly specialized and experienced teams for any specialized maintenance and repair.
- (v) There is a very low utilization of CMMS/ERP among respondents. Also, modern diagnostic equipment are also not commonly used. Subsequently, failure records are poorly maintained, with a majority using manual record keeping.
- (vi) A majority of the companies have safety rules and regulations, which are also reviewed regularly.

#### B. Managerial Aspects

The above aspects were covered by questions 21 to 30 of the questionnaire. The cumulative responses totaled 437. A summary of the responses is presented on Table IV.

TABLE IV  
RESPONSES ON MANAGERIAL ASPECTS

QUESTION NUMBER	NUMBER OF RESPONSES PER MAINTENANCE LEVEL					No. of responses
	L1	L2	L3	L4	L5	
21	3	3	25	11	7	49
22	2	8	2	16	21	49
23	0	14	5	15	14	48
24	12	1	5	18	13	49
25	10	9	8	10	12	49
27	10	8	10	2	19	49
28	1	7	6	19	15	48
29	5	5	1	6	32	49
30	5	5	5	16	16	47
<b>TOTAL</b>	<b>48</b>	<b>60</b>	<b>67</b>	<b>113</b>	<b>149</b>	<b>437</b>

1) *The Managerial Evaluation Index (M.E.I)*: The M.E.I was calculated using equation 1, and found to be **2.94**. Based on equation 2, the Level for technical aspects will be **2**. According to Table I, the managerial aspects of maintenance practices are at the *managed level*.

Some deductions from the responses are as follows:

- (i) Maintenance manuals a generally used, but some improvements have been made on them based on experience.
- (ii) Training of maintenance personnel s normally planned and done continuously on and off the shop floor. Where diagnostic equipment is used, training is properly structured.
- (iii) Technicians work with minimum supervision, and maintenance procedures are reviewed continuously
- (iv) Companies have safety and environmental policies which are reviewed regularly.
- (v) Most companies are certified both locally and internationally.

#### C. Human Aspects

These aspects were covered by questions 33 to 35 of the questionnaire. The cumulative responses totaled 140. A summary of the responses is presented on Table V.

TABLE V  
RESPONSES ON HUMAN ASPECTS

QUESTION NUMBER	NUMBER OF RESPONSES PER MAINTENANCE LEVEL					No. of responses
	L 1	L 2	L 3	L 4	L 5	
33	1	4	27	10	5	47
34	2	11	15	10	9	47
35	7	2	16	0	21	46
<b>TOTAL</b>	<b>10</b>	<b>17</b>	<b>58</b>	<b>20</b>	<b>35</b>	<b>140</b>

1) *The Human Evaluation Index (H.E.I)*: The M.E.I was calculated using equation 1, and found to be **2.564**. Based on equation 2, the Level for technical aspects will be **2**. According to Table I, the managerial aspects of maintenance practices are at the *managed level*.

Some deductions from the responses are as follows:

- (i) Companies had a well defined organization structure
- (ii) Companies pay enough attention to detail when interviewing their technical personnel.
- (iii) Most of the companies do have safety and environmental officers.

*D. The General Evaluation Index (G.E.I)*

The GEI can now be determined from the average of the TEI, MEI and HEI. This was found to be **2.634**. Again, this value is classified under **L 2**. Processes are partially planned and performance analysis depends on the operator experience and competencies. Process management is weak due to deficiencies in the organizational or technical systems.

*E. Index Analysis Per Category Of Industry*

In order to gain a deeper understanding of the maintenance practices in different industrial sectors, an analysis is done per industrial category. Table VI presents this analysis.

TABLE VI  
EVALUATION INDEX PER INDUSTRIAL CATEGORY

Category of industry	T.E.I.	M.E.I.	H.E.I	G.E.I.
Service industries	2.114	2.9	2.111	2.375
Power generation industries	2.586	3.9	2.9	3.129
Food processing industries	2.529	3.193	2.884	2.869
Metal processing industries	1.95	1.689	1.533	1.724
Agro/Chemical industries	2.957	3.989	1.633	2.86
Motor vehicle assembly	2.614	2.367	3.1	2.695
Transport	2.896	3.178	2.9	2.991
Maintenance industries	2.229	2.619	2.478	2.442
Construction industries	1.636	2.106	2.178	1.973
MEAN	2.3901	2.9400	2.4130	2.562
STANDARD DEVIATION	0.6442	0.8549	0.7409	0.6692
VARIANCE	0.4150	0.7308	0.5478	0.4478

From the tabulated data in Table VI, the construction industries are the lowest rated in terms of technical aspects. Practically, the construction sector uses a lot manual labor with very little mechanization. The highest rated is the Agro/chemical industries. The explanation may also be that due to the nature of the products, then, the use of sophisticated machines is not an option. As regards managerial aspects, the Agro/chemical industries are the highest rated with the metal processing

industries rated the lowest. Lastly, the motor vehicle sector becomes the best in terms of human aspects with the metal processing industries coming last in this category. This is also illustrated on Figure 1.

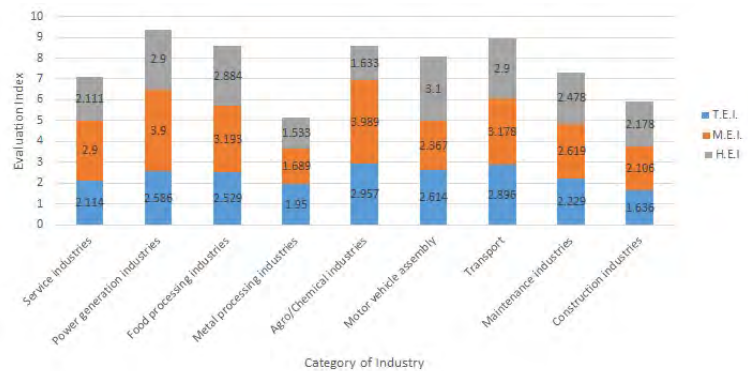

Fig. 1. Maintenance practice aspects of different categories

Where the General evaluation indexes are concerned, the power generation companies have the best general index. The Metal processing industries returned the poorest score, with a level 1

*F. Other observations from the questionnaire*

The questionnaire also provided an area for the assessment of the maintenance personnel in terms of professional qualifications. This is necessary because the quality of work will be affected by the experience and qualifications of the workforce. Figure 3 illustrates the distribution in terms of numbers of the various cadre of professionals working in the maintenance department.

From the data provided, the ratio of engineers, technologist, engineering technician, and craft person/artisans is 1:1:3:6. According to Some [10], the ideal ratio for a developed country should be 1:2:4:16. He farther proposes that a more realistic ratio for a developing country is 1:3:12:60. Thus, industries should employ more craftsmen and artisan to improve the quality of work.

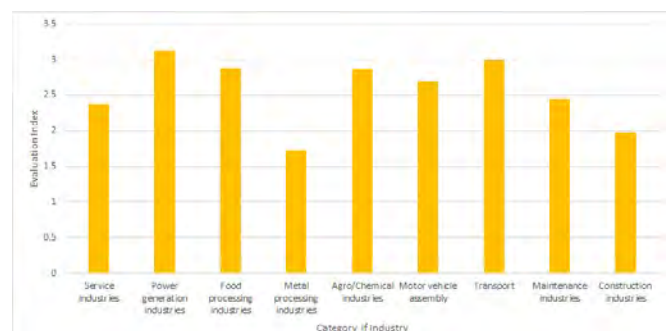

Fig. 2. The General Evaluation Index for different categories

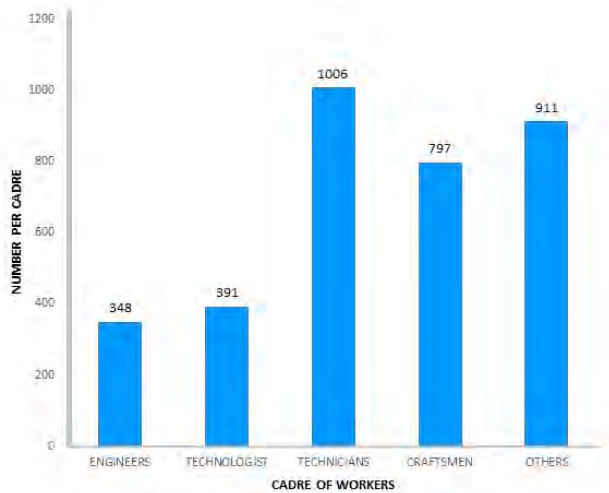

Fig. 3. Number of Maintenance personnel cadres

## VI. CONCLUSIONS AND RECOMMENDATIONS

The research evaluated the maintenance practices applied in the Kenya by using the criteria referred to earlier. The G.E.I was found to be at level 2. The technical aspects (T.E.I.) ranked the lowest, with the managerial aspects (M.E.I.) ranking the best among the three aspects. The companies must aim at achieving the highest standard at level 5.

Based on the survey results, the following are recommendations that can be made to improve maintenance practices in Kenya:

- 1) Computer based Maintenance Management Systems (CMMS) and Enterprise Resource Programs (ERP) need to be introduced in many industries in the country. This should be complemented by additional training on the use of such systems on the shop floor in order to reap maximum benefits from them
- 2) There is a deficiency of craftsmen/women, and more need to be employed.
- 3) Diagnostic equipment should be introduced in the maintenance departments.
- 4) The methods of record keeping in the maintenance department should be improved.

## ACKNOWLEDGMENT

The authors would like to acknowledge the National Commission for Science and Technology, (NACOSTI, REF: 3rd CALL PhD/068), Wärtsilla (EA) Ltd and the Jomo Kenyatta University of Agriculture and Technology (JKUAT) for the support given towards this research.

## REFERENCES

- [1] A. Labib, "World-class maintenance using a computerised maintenance management system," *Journal of Quality in Maintenance Engineering*, vol. 4, no. 1, pp. 66–75, 1998.
- [2] A. Muchiri, B. Ikua, P. Muchiri, and P. Irungu, "Development of a theoretical framework for evaluating maintenance practices," *International Journal of System Assurance Engineering and Management*, 2015.
- [3] M. Macchi and L. Fumagalli, "A maintenance maturity assessment method for the manufacturing industry," *Journal of Quality in Maintenance Engineering*, vol. 19 No. 3, pp. 295–315, 2013.
- [4] K. K. Tabboub, "An assessment of maintenance practices and problems in Jordanian industries," *Jordan Journal of Mechanical and Industrial Engineering*, vol. 5, no. 4, pp. 315–323, 2011.
- [5] E. Mjema and A. Mweta, "An analysis of economics of investing in it in the maintenance department: An empirical study on a cement factory in tanzania," *Journal of Quality in Maintenance Engineering*, vol. 9, no. 1, pp. 411–435, 2003.
- [6] E. Mjema, "Analysis or personnel capacity requirement in maintenance department using simulation method.," *Journal of Quality in Maintenance Engineering*, vol. 8, no. 3, pp. 253 – 273, 2002.
- [7] T. Reiman and P. Oedewald, "Assessing the maintenance unit of a nuclear power plant - identifying the cultural concepts concerning the maintenance work and the maintenance organization," *Safety Science*, vol. 44, pp. 821–850, 2006.
- [8] P. Muchiri, *Performance modeling of manufacturing equipment with focus on maintenance*. PhD thesis, Katholieke Universiteit Leuven, Arenberg Doctoral School of Science, Engineering & technology, 2010.
- [9] K. Pinjala, L. Pintelon, and A. Verrecke, "An empirical investigation on the relationship between business and maintenance strategies," *International Journal of Production Economics*, vol. 104, pp. 214–229, 2006.
- [10] D. Some, "Tertiary education in kenya - what the future holds for us," in *19th Engineers international conference*, IEK, 2012.

# Application of Taguchi method in optimization of Electrical Discharge Machining of AlSiC Metal Matrix Composites

Mwangi J. W, Ikuu B. W, Nyakoe G. N, Kabini S. K and Makenzi M. M

**Abstract**—The recent trends in manufacturing are geared towards miniaturization of products. This has brought about the need to explore new high performance novel materials with desirable mechanical and electrical qualities even in the micro or nano scale. These materials include composites, ceramics and shape memory alloys. Aluminium Metal Matrix Composites (AMMCs) fit this bill well since they have desirable characteristics such as high toughness, high strength to weight ratio, high wear resistance, low value of coefficient of thermal expansion and thermal stability. These qualities have rendered them as suitable candidates for application in automotive, aerospace, defense, nuclear and medical fields.

In this paper, Taguchi method has been used to optimize electrical discharge machining process for aluminium silicon carbide metal matrix composites. Experiments were carried out on AlSiC (AMC225XE) material using high precision micro-erosion machine with a spindle rotation speed of 834 revolutions per minute and workpiece vibration with a vibration frequency of 900 Hz. The parameters to be optimized are gap voltage, pulse time, discharge energy and gain voltage. The results from Taguchi optimization indicate that discharge energy largely influences the output parameters namely MRR, TWR and surface quality. The gap voltage has a significant influence on the MRR whereas the pulse time has a significant influence on the surface quality. Gain voltage has the least influence on the response parameters. Optimum conditions for machining were identified as follows; discharge energy of  $44.7 \mu\text{J}$ , pulse duration of  $3 \mu\text{s}$  and gap voltage of 50 V. These resulted in MRR of  $0.255 \text{ mm}^3/\text{min}$ , TWR of  $0.018 \text{ mm}^3/\text{min}$  and SQ of  $0.89 \mu\text{m}$  which compared favorably to the experimental confirmation tests. The findings of study will be of immense benefit to the industries involved in precision machining of items such as moulds and dies.

**Keywords**—AlSiC Metal Matrix Composite, Electrical Discharge Machining, Material Removal Rate, Surface Quality, Taguchi optimization, Tool Wear Rate

## I. ELECTRICAL DISCHARGE MACHINING

**E**LECTRICAL discharge machining is a process that removes unwanted material by means of a series of recurring electrical discharges between a tool electrode and the workpiece in the presence of a dielectric fluid [1]. This method is mainly used to produce dies, punches, moulds, parts for

aerospace and automotive industry, and surgical components. It is used to machine electrically conductive parts [2].

EDM has important machining parameters which include [3]: Pulse on time, pulse off time, spark gap, discharge current, discharge voltage and duty cycle.

The basic set up of a die sinking electrical discharge machining unit is as shown in Figure 1.

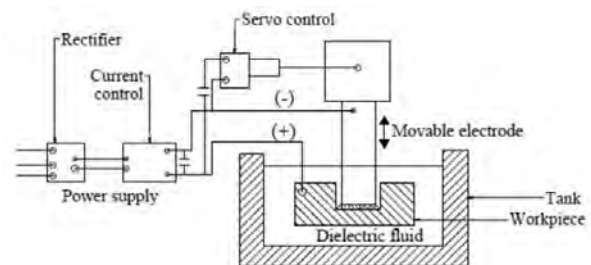

Fig. 1. Setup of an electrical discharge machine

In EDM, like in other machining methods, the important performance measures include material removal rate, surface quality and tool wear rate. In an attempt to improve the performance measures namely MRR, TWR and surface roughness, the challenge encountered is the trade off between the performance parameters. Increasing MRR deteriorates the surface roughness and vice versa. There is therefore a need to get the optimum machine settings. EDM development has looked into hybrid machining whereby other machining methods like ultrasonic machining and chemical machining have been incorporated with EDM.

### A. Working principle of Electrical Discharge Machining.

EDM operates on the principle that when an electric current is applied between a workpiece and an electrode, submerged in a dielectric fluid and separated by a spark gap, a potential difference is created. This potential difference results in pulsed electric discharges which cause material to be removed from the workpiece. The removed material is flushed away from the workpiece by use of the dielectric fluid.

As shown in Figure 2, electrical discharges occur between the tool electrode and the workpiece electrode placed in a dielectric fluid. A voltage is applied between the two electrodes and when it reaches the breakdown voltage of the dielectric medium, a plasma channel is established which allows a current to flow thereby causing a discharge to take

Mwangi J. W, Department of Mechatronic Engineering, JKUAT (phone: +2540724607624; fax: (+25467)52164, 52544; e-mail: jwamai@jkuat.ac.ke).

Ikuu B. W, Department of Mechatronic Engineering, JKUAT (e-mail: ikua\_bw@eng.jkuat.ac.ke ).

Nyakoe G. N, Department of Mechatronic Engineering, JKUAT (e-mail: nyakoe@eng.jkuat.ac.ke).

Kabini S. K, Department of Mechatronic Engineering, JKUAT (e-mail: kkabini@eng.jkuat.ac.ke ).

Makenzi M. M, Department of Mechatronic Engineering, JKUAT (e-mail: macbenmm@gmail.com ).

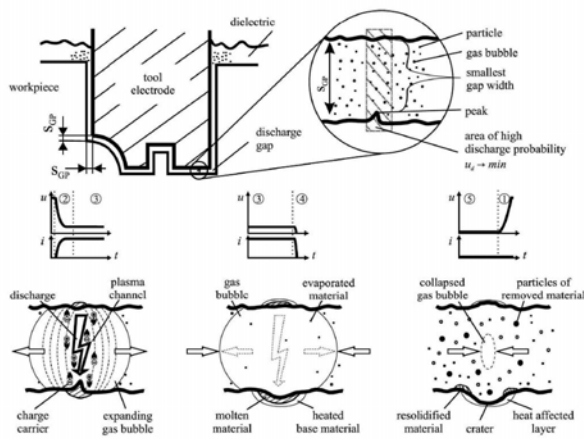

Fig. 2. Material removal mechanism in EDM [4]

place. Localized temperature of over  $10,000^{\circ}\text{C}$  can be reached at the base of the plasma, hence melting and evaporating the workpiece electrode material. The dielectric fluid helps to cool the workpiece and tool by quenching the spark. After stopping the energy input, the discharge ends leading to a collapse of the plasma channel as well as the surrounding gas bubble. A reflow of the dielectric medium occurs which cools the electrode surface and also causes the liquid material to be flushed away. This marks the end of one discharge and when a voltage is attached to the electrodes again, the setup is prepared for the next discharge. A discharge will naturally take place where the breakdown barrier is lowest and this is when the spark gap is the smallest. A constant repetition of the process causes the tool electrode to be reassembled in the workpiece resulting in a transfer of geometry. Essentially, due to the nature of the EDM process, the surface is an assembly of single discharges hence the crater like topology that is observed when the machined surface is viewed under a microscope. As a result, the geometrical accuracy and surface roughness depends on the crater shape and size [4].

EDM has an estimated discharge efficiency ratio of between 30-50% which essentially means that the rest of the discharges are not optimal. The presence of short circuits, open circuits and long arc discharges affect not only machining but also electrode wear, form distortion and MRR. It is therefore very important to optimize the process to deliver optimal or at least constant environmental parameters in order to find a suitable machining set up [4].

## II. OPTIMIZATION METHODS

Since there are quite a number of input and output parameters involved in EDM, it is very difficult to relate input and output parameters manually [5], which necessitates the need for optimization processes.

There are two categories of optimization namely modeling techniques and novel techniques. Modeling techniques deal with mathematical modeling, artificial intelligence and optimization techniques whereas novel techniques deal with other machining principles that can be used in conjunction with

EDM to improve efficiency of the process by offering better MRR and surface quality [6].

Several techniques have been used in optimizing performance parameters in electrical discharge machining. The most commonly used are Taguchi method, fuzzy logic control, genetic algorithm, adaptive fuzzy control and artificial neural networks (ANN). These methods are explained in the next sub-section.

### A. Fuzzy Logic Control

Fuzzy logic is a tool that can be used to deal with decision making problems that are uncertain, imprecise or qualitative. It uses heuristic information and provides a convenient method for the design and implementation of nonlinear controllers. A Fuzzy Logic Controller (FLC) comprises of 4 functional blocks namely fuzzification, inference engine, rule base and defuzzification [7].

The advantages of fuzzy logic control include its capacity to represent inherent uncertainties of the human knowledge with linguistic variables, easy interpretation of the results, easy extension of the rule base of knowledge and robustness in relation to the possible disturbances in the system [8]. However, fuzzy logic control has the limitations that it is incapable of generalizing since it only responds to what is written in its rule base [8].

### B. Genetic Algorithm

Genetic algorithm (GA) is an evolutionary algorithm that uses genetic operators to obtain optimal solutions without any assumptions about the search space. GA works with a population of feasible solutions and, therefore, it can be used in multi-objective optimization problems to capture a number of solutions simultaneously [9].

Due to its robust nature, GA is best suited to solve problems in which the objective function is discontinuous, non differentiable, stochastic or highly nonlinear. The main characteristic of GA is that it operates simultaneously with a large set of search space points and employs multiple starting points thereby speeding up the search process [10]. However, GA has the limitations of complexity especially when the evaluation requires an extensive computation [11].

### C. Artificial Neural networks

Artificial Neural networks optimization method is based on biological neural networks which try to shape the functions of the human brain. Neurons are idealised as discrete units of distributed processing and local or global connections inside a network are also idealized leading to the capacity of the system in assimilating, learning or to foreseeing reactions or decisions to be taken. Adaptive Neural Fuzzy Inference System (ANFIS) combines aspects of Neural Networks and Fuzzy Logic. It uses fuzzy if-else rules to model the qualitative aspects of human knowledge and reasoning to control a system without employing precise qualitative analysis [12]. Neural networks have the advantages that they have a learning capacity, a generalization capacity and are robust in relation to disturbances.

They however have a limitation in their complexity since it is difficult to determine the number of layers and number of neurons in a network [8].

### III. TAGUCHI OPTIMIZATION

Taguchi is an optimization method developed by Genichi Taguchi [13]. It is an important tool for quality improvement in product and manufacturing process design [14]. In this method, the experimental values are transformed into a signal-to-noise (S/N) ratio whereby the term “signal” represents the desirable value for the output characteristic and the term ‘noise’ represents the undesirable value for the output characteristic.

There are three categories of the performance characteristics in the analysis of the S/N ratio, that is, “lower-the-better” (LB), “nominal the better” (NB) and “the higher-the-better” (HB). These are defined by Equation 1, 2 and 3, respectively. LB represents the better machining performance in the case of surface roughness (SR), spark gap or gap width (Wg) and gap current (Ig) whereas HB represents the better machining performance in the case of MRR. After conducting a S/N analysis, ANOVA is performed to see which process parameters are statistically significant [13].

$$S/N_{LB} = -10\log_{10} \left[ \frac{\sum_{i=1}^n y_i^2}{n} \right] \quad (1)$$

$$S/N_{NB} = 10\log_{10} \left[ \frac{1}{S^2} \right] \quad (2)$$

$$S/N_{HB} = -10\log_{10} \left[ \frac{1}{n} \left( \sum_{i=1}^n \frac{1}{y_i^2} \right) \right] \quad (3)$$

where:  $y_i$  is the value of the response,  $i$  is the  $i^{th}$  experiment condition, with  $i = 1, 2, 3, \dots, n$  and  $S^2$  is the sample mean and variance.

Jawalkar *et al.* [15] carried out optimization of process parameters to minimize the surface roughness of the rapidly resolidified layer of Al 7075 MMC while machining using EDM process using the Taguchi technique. The gap current, pulse on-time and pulse off-time were considered as process parameters and the formation of resolidified layers was investigated in terms of the surface roughness. They reported that pulse on-time had the least influence on recast layer surface roughness inside the hole whereas gap current had the least influence on recast layer surface roughness near hole surface. They however did not report on the optimization of other response parameters which are key to the machining output namely MRR and TWR

Khan and Singh [16] used Taguchi method in EDM machining of Al/SiC MMC using non rotating and rotating electrodes. Material removal rate and electrode wear rate were the response variables under investigations whereas the machining parameters studied included pulse on time, pulse off time, voltage and peak current. The results indicated that the most dominant factors which affect the MRR and TWR were peak current and pulse on time.

In the present study, Taguchi method has been applied in the optimization of electrical discharge machining of aluminium silicon carbide metal matrix composites.

### IV. EXPERIMENTAL PROCEDURE

Experiments were designed using Taguchi method using an L9 orthogonal array since it allowed for the study of the four different factors under consideration in this study i.e discharge energy, gap voltage, pulse time and gain voltage.

The design layout was generated using Stat- Ease Design software and is as shown in Table I.

TABLE I  
L9 DESIGN LAYOUT

Factor name	Levels		
	1	2	3
Gain (V)	250	450	650
Gap (v)	25	50	75
Discharge energy level	104	202	302
Pulse time, $\mu$ s	3	4	5

A design matrix was generated as shown in Table II. It specified the different combination of parameters to be chosen for each experiment.

TABLE II  
DESIGN MATRIX OF L9 ORTHOGONAL ARRAY

Exp. No.	Parameters			
	Gain (V)	Gap voltage (v)	Discharge energy level	Pulse time ( $\mu$ s)
1	250	25	104	3
2	450	75	104	4
3	450	25	202	5
4	250	50	202	4
5	650	50	104	5
6	650	25	302	4
7	450	50	302	3
8	250	75	302	5
9	650	75	202	3

The responses to be optimized were material removal rate, tool wear rate and surface quality. In order to calculate the S/N ratio for each response, the minimum change the design should detect as statistically significant (signal) as well as the estimated standard deviation (noise) was determined as shown in the Table III.

TABLE III  
S/N RATIO FOR RESPONSES UNDER INVESTIGATION

Response name	Minimum change to detect (Signal)	Estimated standard deviation (noise)	signal/noise ratio
MRR, (mm <sup>3</sup> /min)	2	0.5	4
TWR (mm <sup>3</sup> /min)	2	0.5	4
SQ ( $\mu$ m)	2	0.5	4

A Signal/Noise ratio of 4 was chosen for each response which results in a 92.2% Taguchi design power. This is well above the recommended power of 80%.

The EDM machine used (SARIX-100) had provisions for selecting the desired energy level through the control panel. Once the desired parameters were selected, experiments were



conducted and an oscilloscope was used to study the pulses generated.

Typical curves of discharge current versus time for different energy levels are shown in Figure 3. These curves helped in establishing the current and pulse time associated with each discharge energy level and aided in calculation of the actual discharge energy for each level as shown in Table IV.

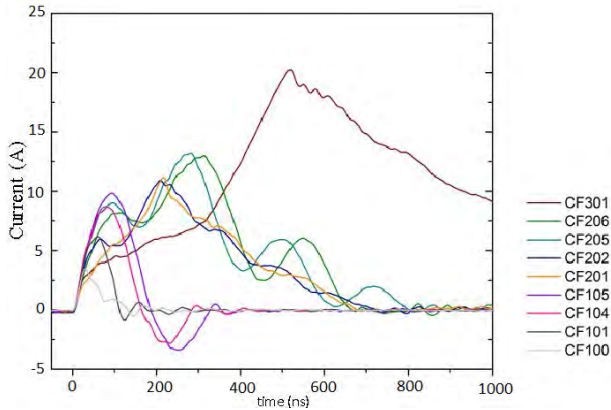

Fig. 3. Discharge current vs time for different discharge energy levels

In order to avoid systematic errors, the experiments were performed randomly. After conducting the experiments, the results were analysed to establish the optimum machining conditions. Each response parameter was analysed separately with an aim of establishing the machining parameters that are statically significant.

To establish the values for MRR, the volume,  $V_m$  of each bore was measured using the volume measurement function of MountainsMap<sup>®</sup> scanning topography surface analysis software and calculated as shown in Equation 4.

$$MRR = \frac{V_m}{t_m} \quad (4)$$

TWR was calculated using Equation 5.

$$TWR = \frac{\pi \times r^2 \times (l_s - l_f)}{t_m} \quad (5)$$

where:  $r$  is the radius of the electrode,  $l_s$  is the electrode length before machining,  $l_f$  is the electrode length after machining and  $t_m$  is the machining time.

Bore surface topographies and roughness were measured using 3D laser scanning microscope, (Keyence VK-9700), and analysed using MountainsMap<sup>®</sup> scanning topography software.

## V. ANALYSIS

### VI. TAGUCHI DESIGN ANALYSIS

After the optimization experiments, the MRR, TWR and Surface Quality were calculated and tabulated as shown in Table V. MRR was calculated as the volume of material removed over the machining time whereas TWR was calculated as the volume of tool wear over the machining time. Surface quality was calculated by getting the arithmetic average of the absolute values of the peaks and the valleys in the surface

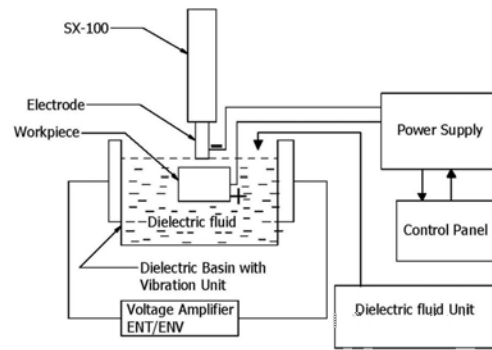

Fig. 4. Layout of experiments

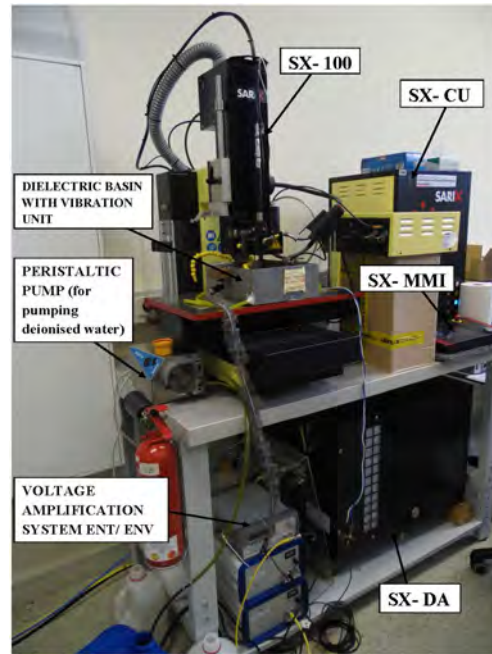

Fig. 5. Equipment setup for experiments

under study. It can be seen that MRR and TWR increase with increase in the discharge energy level. Gain voltage was not statistically significant in all the response parameters namely MRR, TWR and surface quality.

### A. Material Removal Rate

The first step was to check whether a transformation was needed or not. In this design, the MRR response range was very large prompting the need for a natural log transformation.

After identifying the statistically significant values, a half normal plot of the effects was drawn as shown in Figure 6. ANOVA and statistical analysis was then done to check the probability (“p-value”) for the model. Values of  $\leq 0.5$  were considered to be significant. For MRR, both discharge energy and gap were found to be statistically significant.

An interaction of the two significant factors was drawn as shown in Figure 7. It was seen that increase in discharge energy resulted in increase in material removal rate. Also, an increase in gap voltage resulted in an increase in material

TABLE IV  
ENERGY ASSOCIATED WITH EACH ENERGY LEVEL (CF)

ENERGY LEVEL	CF100	CF101	CF104	CF105	CF201	CF202	CF205	CF206	CF301
ENERGY ( $\mu J$ )	2.6	6.9	16.9	26.3	47.7	44.6	51.2	47.3	228.0

TABLE V  
EXPERIMENTAL RESULTS FOR TAGUCHI OPTIMIZATION

Exp. No.	Factor 1	Factor 2	Factor 3	Factor 4	Response 1	Response 2	Response 3
	Gain, V	Gap, v	Discharge energy level	Pulse, $\mu s$	MRR, $mm^3/min$	TWR, $mm^3/min$	SQ (Ra), $\mu m$
1	250	25	104	3	0.0235	0.0013	0.50
2	450	75	104	4	0.0396	0.0024	0.57
3	450	25	202	5	0.1402	0.0167	0.97
4	250	50	202	4	0.2716	0.0115	0.95
5	650	50	104	5	0.0401	0.0022	0.63
6	650	25	302	4	0.3995	0.0393	1.42
7	450	50	302	3	0.6633	0.0726	1.38
8	250	75	302	5	0.7242	0.0967	1.43
9	650	75	202	3	0.2412	0.0229	0.89

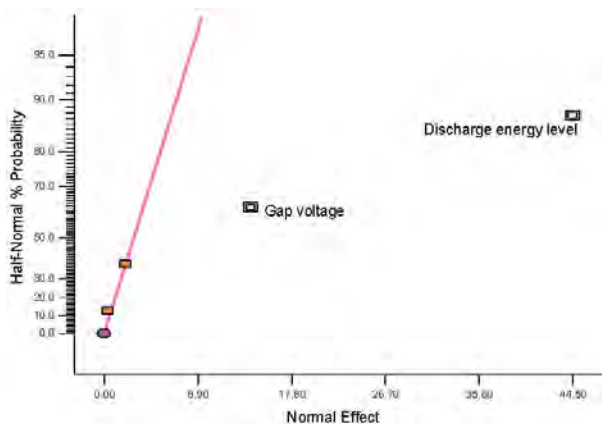

Fig. 6. MRR half normal plot

removal rate up to a maximum after which a further increase resulted in a decrease in MRR. This could be because a very small spark gap results in a lot of short circuits whereas a big spark gap results in very few discharges [17].

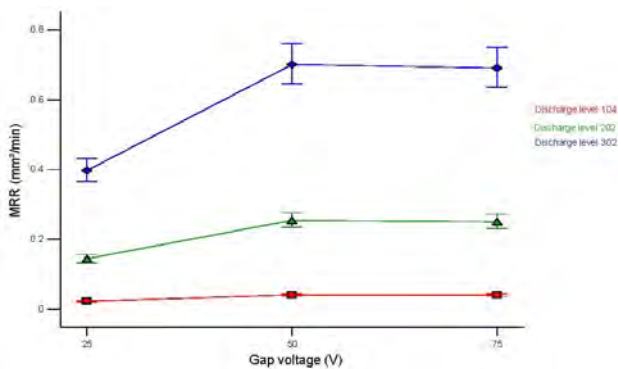

Fig. 7. Gap voltage vs MRR for different discharge energy levels

### B. Tool Wear Rate

The natural log transformation was also chosen for TWR analysis since the response range was from 0.001281 to 0.0967  $mm^3/min$  with a ratio of 75.5. For TWR, only discharge energy level was found to be statistically significant as can be seen in Figure 8.

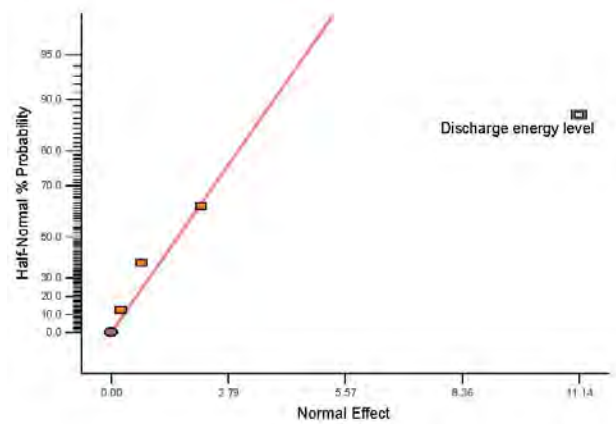

Fig. 8. TWR half normal plot

A graph of discharge current versus the tool wear rate was drawn as shown in Figure 9. From the graph, it can be seen that tool wear rate increases with increase in discharge energy.

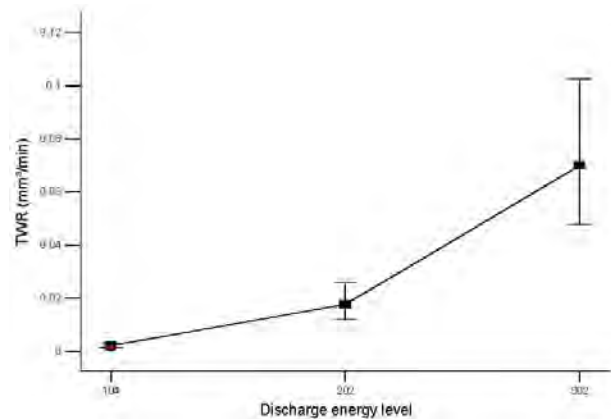

Fig. 9. Effect of discharge energy level on TWR

### C. Surface quality

Owing to a small response range, no transformation was required for surface quality analysis. As shown in Figure 10, both the discharge energy as well as the pulse duration were found to be statistically significant with regard to the surface quality.

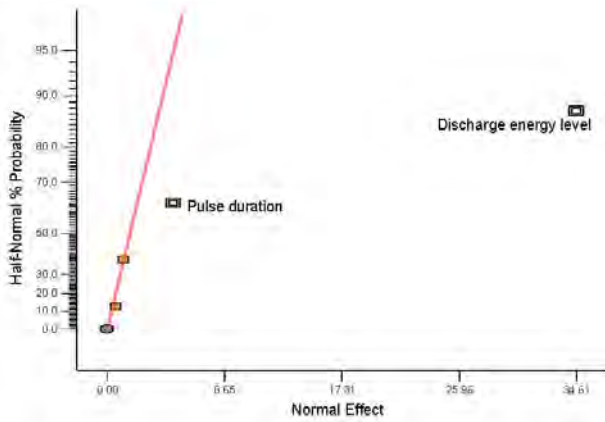

Fig. 10. Surface quality half normal plot

An interaction of discharge current and pulse time is drawn as shown in Figure 11. It was seen that increase in discharge energy and pulse time resulted in an inferior surface quality.

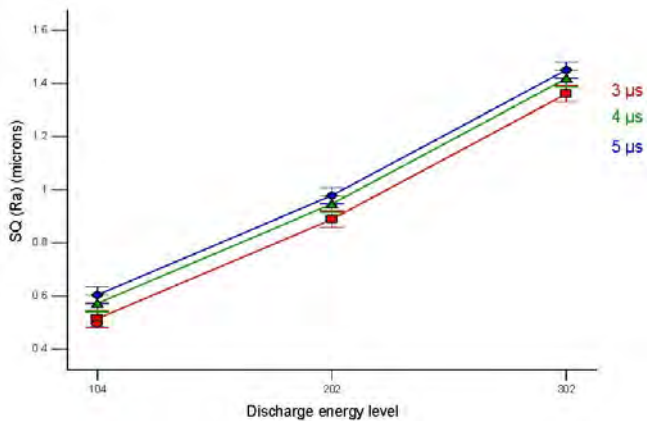

Fig. 11. Surface quality vs discharge energy level for different pulse times

#### VII. TAGUCHI DESIGN OPTIMIZATION

“The higher the better” setting was chosen for material removal rate whereas “the lower the better” setting was chosen for both tool wear rate and surface quality.

Figure 12 shows the established optimum machining conditions for each machining parameter (factor) whereby the optimum level (treatment) for each factor is identified by a dot. It can be seen that a discharge energy of 44.6  $\mu\text{J}$ , a gap voltage of 50 V and a pulse duration of 3  $\mu\text{s}$  were the optimum machining conditions resulting in an MRR of 0.255  $\text{mm}^3/\text{min}$ , TWR of 0.018  $\text{mm}^3/\text{min}$  and SQ of 0.89  $\mu\text{m}$ . These conditions are for a case where MRR, TWR and SQ are all equally important response parameters.

Where the aim is to maximise MRR and where TWR and SQ are not important, a discharge energy of 228  $\mu\text{J}$ , a gap voltage of 50 V and a pulse duration of 3  $\mu\text{s}$  would be the suitable choice of machining parameters resulting in an MRR of 0.701  $\text{mm}^3/\text{min}$ , TWR of 0.070  $\text{mm}^3/\text{min}$  and SQ of 1.36  $\mu\text{m}$ .

Where the aim is achieve the best surface quality and where TWR and MRR are not important, a discharge energy of 16.9

$\mu\text{J}$ , a gap voltage of 50 V and a pulse duration of 3  $\mu\text{s}$  would be the suitable choice of machining parameters resulting in an MRR of 0.041  $\text{mm}^3/\text{min}$ , TWR of 0.002  $\text{mm}^3/\text{min}$  and SQ of 0.51  $\mu\text{m}$ .

These three cases demonstrate a trade off between MRR and SQ in that, in order to get a better surface quality, one must compromise on MRR and vice versa.

#### VIII. CONFIRMATION EXPERIMENTS

The optimum conditions established in Taguchi optimization were used to machine AISiC MMC in order to verify them experimentally. As shown in Table VI, actual experimental values resulted in an MRR of 0.291  $\text{mm}^3/\text{min}$ , TWR of 0.165  $\text{mm}^3/\text{min}$  and SQ of 0.94  $\mu\text{m}$ . These values are comparable to the Taguchi optimization values and hence indicate that this method can be suitably used to optimize the EDM of AISiC process.

TABLE VI  
COMPARISON OF PREDICTED AND ACTUAL RESPONSE PARAMETER VALUES

Response parameters	Taguchi optimisation values	Experimental values	% difference
MRR ( $\text{mm}^3/\text{min}$ )	0.255	0.2913	14.2
TWR ( $\text{mm}^3/\text{min}$ )	0.0176	0.0165	6.3
SQ ( $\mu\text{m}$ )	0.889	0.941	5.8

#### IX. SUMMARY

In this study, Taguchi optimization was used to establish the optimum machining conditions. These optimum conditions were then experimentally verified and found to be comparable. Therefore, the objectives of this study were successfully realized.

#### X. CONCLUSION

In this paper, Taguchi method was used to optimize the electrical discharge machining method while machining aluminium silicon carbide metal matrix composites. From the analysis, the following conclusions can be drawn.

- Discharge energy largely influences all the response parameters namely material removal rate, tool wear rate and the quality of the surface generated. An increase in discharge energy results in an increase in both material removal rate and tool wear rate. It also results in an inferior surface quality.
- The longer the pulse duration, the poorer the surface finish.
- Increase in gap voltage results in an increase in material removal rate up to a maximum after which a further increase results in a decrease in material removal rate.
- The optimum machining conditions for machining of AISiC are a discharge energy of 44.6  $\mu\text{J}$ , a gap voltage of 50 V and a pulse duration of 3  $\mu\text{s}$ . Under these conditions, the MRR is 0.255  $\text{mm}^3/\text{min}$ , the TWR is 0.018  $\text{mm}^3/\text{min}$  and the resulting surface will have a surface roughness of 0.89  $\mu\text{m}$ .

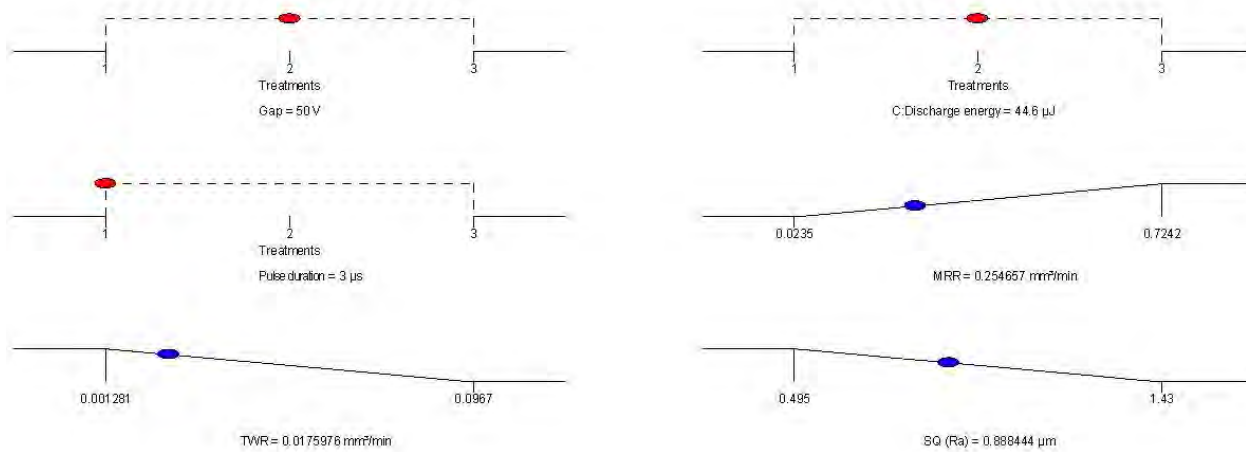

Fig. 12. Optimum machining conditions

## XI. RECOMMENDATIONS

- Further research is required to establish if the optimum machining parameters established in this study on machining of AISiC MMCs can be extended to other materials.

## ACKNOWLEDGEMENTS

This researchwork was co-financed by the German Academic Exchange Service (DAAD) and Jomo Kenyatta University of Agriculture and Technology (JKUAT). The authors gratefully recognize the support and contribution from the Professorship of Micromanufacturing Technology at Technische Universität Chemnitz where the experiments were done.

## REFERENCES

- [1] A. Pandey and S. Singh, "Current research trends in variants of Electrical Discharge Machining : A review," *International Journal of Engineering Science and Technology*, vol. 2, no. 6, pp. 2172–2191, 2010.
- [2] K. Ojha, R. K. Garg, and K. K. Singh, "MRR Improvement in Sinking Electrical Discharge Machining : A Review," *Journal of Minerals & Materials Characterization & Engineering*, vol. 9, no. 8, pp. 709–739, 2010.
- [3] N. M. Dhirendra, A. Bhatia, and R. Vaibhav, "Study on Electro Discharge Machining ( Edm )," *The International Journal Of Engineering And Science*, vol. 3, no. 2, pp. 24–35, 2014.
- [4] A. Schubert, H. Zeidler, M. Hackert-Oschätzchen, J. Schneider, and M. Hahn, "Enhancing Micro-EDM using Ultrasonic Vibration and Approaches for Machining of Nonconducting Ceramics," *Journal of Mechanical Engineering*, vol. 59, no. 3, pp. 156–164, 2013.
- [5] Y. Chowdary, C. Yuvaraj, K. Rao, and B. Durgaprasad, "Neural Network for Prediction of EDM of Al/Sic-Graphite Particulate Reinforced Hybrid Composites," *Citeseer*, vol. 2, no. 12, pp. 730–739, 2012.
- [6] V. Sreebalaji and R. Saravanan, "Advanced electrical discharge machining and TRIZ," *The TRIZ Journal*, pp. 1–9, 2009.
- [7] Y. Bai and D. Wang, "Fundamentals of Fuzzy Logic Control - Fuzzy Sets, Fuzzy Rules and Defuzzifications," in *Advanced Fuzzy Logic Technologies in Industrial Applications*, pp. 17–36, Springer, 2006.
- [8] J. Vieira, F. M. Dias, and A. Mota, "Neuro-fuzzy systems: a survey," in *5th WSEAS NNA International Conference on Neural Networks and Applications, Udine, Italia*, 2004.
- [9] D. Kanagarajan, R. Karthikeyan, K. Palanikumar, and J. P. Davim, "Optimization of electrical discharge machining characteristics of WC/Co composites using non-dominated sorting genetic algorithm (NSGA-II)," *The International Journal of Advanced Manufacturing Technology*, vol. 36, pp. 1124–1132, Jan. 2007.
- [10] F. Kolahan, "Modeling and optimization of process parameters in PMEDM by genetic algorithm," *World Academy of Science, Engineering and ...*, pp. 480–484, 2008.
- [11] C. Z. Janikow, "A knowledge-intensive genetic algorithm for supervised learning," *Machine Learning*, vol. 13, no. 2-3, pp. 189–228, 1993.
- [12] J.-S. R. Jang, "ANFIS: Adaptive- Network - Based Fuzzy Inference System," *IEEE Transactions on Systems, Man, and Cybernetics*, vol. 23, no. 3, pp. 665– 685, 1993.
- [13] V. Saini, Z. Khan, and A. Siddiquee, "Optimization of Wire Electric Discharge Machining of composite material (AL6061/SICP) using Taguchi method," *irnet.sg*, pp. 61–64, 2013.
- [14] K.-L. Tsui, "An overview of Taguchi method and newly developed statistical methods for robust design," *Iie Transactions*, vol. 24, no. 5, pp. 44–57, 1992.
- [15] R. S. C. S. Jawalkar, R. R. Mishra, A. K. Sharma, and P. Kumar, "Study of Recast Layers and Surface Roughness on Al-7075 Metal Matrix Composite during EDM machining," *International Journal of Recent advances in Mechanical Engineering*, vol. 3, no. 1, pp. 53–62, 2014.
- [16] E. F. Khan and E. B. Singh, "Machining of Al / Sic MMC on EDM," *International Journal of IT, Engineering and Applied Sciences Research*, vol. 1, no. 2, pp. 28–30, 2012.
- [17] J. W. Mwangi, G. N. Nyakoe, B. W. Ikua, H. Zeidler, and K. S. Karanja, "Effect of Low Frequency Vibration in Electrical Discharge Machining of AISiC Metal Matrix Composite," *Journal of Sustainable Research in Engineering*, vol. 1, no. 2, pp. 45–50, 2014.

# Scouring abandoned mines in search for elusive metal (gold) in Kakamega's Rosterman area - A case study in Kenya

Mathew Ndeto Kyalo, Irene Fedha Munyerere, B. Rop and S. M. Maranga

**Abstract**—Artisanal and small scale gold mining (AGSM) is an economic activity carried out by thousands of people across the globe. In Kenya these activities are concentrated in the Western and Northern regions. One of these areas is the Kakamega County in specific the Rosterman area. The name originates from a British gold mining company, Rosterman Gold Mines which was licensed to mine gold in 1930s before Kenyans independence. Since the exit of the company operations in 1952, small scale miners have been mining on the tailings of the abandoned mines to date. The activity is mostly poverty-driven and the small scale miners face a myriad of problems including rudimentary mining methods, poor processing practices and exploitation by brokers. The mining activities pose negative impacts to the environment and human health. This paper highlights the challenges and gives some achievable solutions to improve the mining activity as well as the living standard of the locals.

**Key words:** AGSM, Comminution, Mercury, Gold resource centre

## I. INTRODUCTION

Gold is a rare element. The average concentration of gold in the earth's crust is 0.004g/tonne (0.004 grams of gold in one tonne of rock) [1]. A gold deposit becomes interesting for economic exploitation with grades usually above 0.2g/tonne. A rich gold deposit has gold grades above 10 g/tonne. The extraction of gold does not depend only on the gold grade but also the mineralogy of the gold (i.e. how the gold occurs in the ore, as well as the accessibility and infrastructure of the site).

Mankind has been extracting gold from hard rock and alluvial deposits for more than three thousand years. Impure gold, as it commonly occurs in deposits, has a density of 16 to 18, whereas the associated waste rock (gangue) has a density of about 2.5 [2]. The difference in density enables gold to be concentrated by gravity and permits the separation of gold from clay, silt, sand, and gravel by various agitating and collecting devices such as the gold pan, rocker, and sluice box.

Unaffected by air, moisture, heat or cold, this noble metal does not tarnish, rust or corrode. It is the most malleable and ductile of metals. Its rating is 2.5 – 3 on Moh's scale of hardness. It has a specific gravity of 19.3 in its pure form compared to 14.0 for mercury and 11.3 for lead.

Mathew N. Kyalo, Irene F and S. M. Maranga, Department of Mechanical Engineering, JKUAT (corresponding author to provide phone: +2540706518947; fax: +2546752711; e-mail: mnkyalo@jkuat.ac.ke).

B. Rop., Department of Mining, Materials and Petroleum Engineering, JKUAT

Gold is used globally as a monetary equivalent in different currencies for prospective purposes. It also finds application in jewelry and allied wares, electrical-electronic applications. It is also used in medical fields such as dentistry, and in the ancient times it was used for healing therapy when worn as bracelet. It is also used in the aircraft-aerospace industry, the arts, décor (as in Buddhist temples in the east) and chemical fields.

In Kenya, gold is known to occur in gold bearing greenstone rocks of Nyanzian Craton in Western Kenya [3]. Areas with alluvial gold are being harvested by local miners through conventional panning in the northern part of the country. The counties with gold deposits are: Kakamega, Migori, Transmara, Bondo, Siaya, Pokot and minor indications in Nandi area. Gold panning in Turkana was first reported in 2005 as occurring at Lochoremoit, Namoruputh, Lokiriama and Ngakoriyeik [4]. In these counties artisanal and small scale mining (AGSM) activities exists as a major economic activity and in many cases as a major source of livelihood [5]

This paper explores AGSM in Kakamega's Rosterman area, outlining the activities carried out, the challenges faced and finally proposes recommendations addressing these challenges. These challenges are not unique to the location but are similar to those faced by AGSM in other areas. The recommendations are obtained from past research and customized to suit the particular setting. They are also in line with proposed government policies of the National Economic and Mineral Policy.

### A. History Rosterman Area

Kakamega County, (0.2833° N, 34.7500° E) in western Kenya Gold mining in Kakamega District was started by a British company by the name Rosterman Gold Mines, incorporated and licensed in early 1930's to prospect and mine gold ores. Since the exit of the British company, the interest in exploring gold deposits was left to area residents and other small-scale miners. The villagers have for years been scouring the abandoned mines in search of this elusive mineral to date.

### B. Mining methods

The artisanal and small-scale miners process two major categories of gold ores: alluvial and hard rocks. The mining in this area can be categorized into alluvial mining and hard rock mining. Alluvial mining involves digging ore from the slow moving sections of river Isiukhu. The gravels of the ore excavated from these river and tailings on site are usually carried to suitable locations for processing either by sluicing or panning. In some places, work is organized in 'family' groups with the men digging the ore and the women doing the sluicing and panning, while in others areas, women only carry the ore from the pits to the processing site.

The hard rock, which may be lode or reefs, could be free milling or refractory ores. Hard rock mining is an underground operation which features in open pits with the overburden removed manually by the miners. Others methods feature narrow, vertical/inclined shafts or adits for access to the ore body. The miners deploy a variety of tools (shovels, picks, hammers, axes, chisels, metal bars, mattocks, among others.) to loosen and excavate the ore, especially when in the form of weathered quartzite veins. The ore is then shoveled into sacks and buckets and transported to the shaft.

### C. Ore Processing

After mining, the ore is processed to liberate or separate gold grains. In the case of alluvial ores, liberation is accomplished by scrubbing and washing, while comminution is used for hard rock. Primary separation is generally conducted in sluice boards and the sluice concentrate is cleaned in pans before amalgamation. The processing sites are separate from the mining areas and at the proximity of sources of water and power. Some sites act as independent central processing centers that provide a service and treat ore from different sites in their vicinity. The ore is either transported using hired trucks or hand carts, and if within a reasonable distance, carried in sacks.

### D. Washing and Screening

The main pre-concentration processes performed on alluvial material are washing and screening. Washing is carried out mainly on alluvial gold ores to remove pebbles, break up clay and remove slimes. The extent and mode of washing usually depends on how strongly the clay adheres to the surface of the gold. If the clay content is low and adhesion to the mineral surface is weak, washing and screening are done simultaneously, usually by shaking a hand held screen (with the material in it) in water. Other miners perform this operation by pounding and shearing the material with their feet in basins after pre-soaking with water. The process continues until the gravel and sands are relatively clean. Screens used in gold processing are usually selected on the basis of gold particle size in the area under consideration (with 'nuggety' areas using screens with larger openings). Most small scale miners use metal woven screens for coarse separation and rayon-type material for fine screening.

### E. Communication

Liberation from hard rock ores begins with comminution. Size reduction is done using hammers and ball mills. The big rocks are crushed manually while secondary milling, ball mills acquired mostly from Tanzania are used for grinding the ore into fine particles. In most processing centers, the units may only work for part of the day, unless there is sufficient ore available for continuous operation.

### F. Concentration

The miners use crude homemade sluices made of wood sluice boxes lined with either a basic blanket, towel, carpet or jute material. Most sluices seen during the survey only had one type of lining that is not applicable to all particle sizes. In most sites visited, the sluiced tailings are scavenged several times before they are finally discarded to increase retrieval of gold particles lost in previous operations. There is a lot of scope for improving the design of the sluice boxes used.

After the first separation operation such as sluicing, concentrates consisting of black sands with a small percentage of gold are produced. These are generally cleaned by hand panning in wooden or rubber pans (cut from rubber sheets). This panning produces a gold-rich concentrate but this still contains a lot of black sand. Separating the gold from this concentrate is easy if the gold is coarse but a major problem when it is very fine grained. In most places, miners use mercury amalgamation to separate the gold from the black sands.



Fig. 1: Sluice used for concentration of gold ore

## II. CHALLENGES FACING AGSM

Small-scale mining can be extremely damaging to environmentally with serious health and safety consequences for workers and surrounding communities [6]. AGSM can play a crucial role in poverty alleviation and rural development; most of those involved are poor and mining represents the most promising, if not the only, income generating opportunity available [7]. However, the sector is

perhaps better known for its high environmental costs and poor health and safety record [8].

#### *A. Prospecting and Mining*

Exploration is one of the most difficult aspects of mining. ASGM mainly relies on prospecting by trial and error - walking the ground and testing for gold content. In general, there is little regard for proper health and safety procedures, and underground mining in particular is a dangerous and hazardous activity. The miners face daily and immediate danger of rock falls that kill or maim instantly. Technology in mining has increasingly advanced leaving many small scale miners still using rudimentary mining methods partly due to poverty and ignorance. The miners often work as a team using open pit method. The gangue is removed manually to unravel gold veins. The gold is crushed and then carried to a nearby Isukhu river to pan and separate the gold. This method of mining requires a great amount of labor, and is very slow, time consuming and not very profitable. Working inside these mining pits is the most dangerous method of gold mining with frequent cave-ins and suffocation from carbon monoxide emitted by generators [9]. The miners are exposed to other hazards and uncomfortable conditions on the mine [10]. The act of drilling produces large quantities of dust.

#### *B. Processing*

After mining the process of crushing and grinding (comminution) the gold ore follows. The processing method involves grinding, panning in the river and use of mercury to amalgamate gold. The grinding process involve milling machines whose efficiency is not optimized leading to wastage of energy and direct increase in cost. These mills break down and require repairs on a very frequent basis. There are extremely high levels of airborne dust at the centralized processing plants as this grinding is invariably dry. In many cases, the comminution is carried out inside huts or buildings with no proper ventilation to remove the dust. In such places, the workers are exposed to dangerous levels of siliceous dust and high noise levels but are rarely suitable. Personal Protection Equipment (PPE), dust masks or ear plugs. The noise level is very high as shown in Table A1 shows the noise levels in decibels as measured from a ball missing site in Rosterman area. Prolonged exposure to unacceptable noise levels and can lead hearing damage [7].

Panning is a gold processing method which involves separating gold particles from the ore by gravity. The process requires a lot of water and is done on the river which has led to shrinking of the river. Although other activities like deforestation and poor farming methods have contributed to shrinking of the river, the gold processing activities have also added a share to the shrinking of the river.

#### *C. Mercury Use and Environmental Effects*

Mercury vapors in the air around amalgam burning sites can be alarmingly high and almost always exceed the WHO limit for public exposure of  $1.0 \mu\text{g}/\text{m}^3$  [8]. These exposures affect not only ASGM workers but also those in the communities surrounding the processing centers. The

vaporized mercury eventually settles in soil and the sediment of lakes, rivers, bays, and oceans and is transformed by anaerobic organisms into methyl mercury. Mercury exposure in ASGM communities is associated with adverse health effects including kidney dysfunction, autoimmune dysfunction, and neurological symptoms [9]. Mercury that poses long term hazard from a slow cumulative poison may seem a comparatively small risk. Mercury is toxic and inhalation can harm nervous, digestive and immune systems, lungs and kidneys, according to the World Health Organization. Inhaled mercury can be fatal, according to the World Health Organization (WHO).

#### *D. Economics*

Many of the potential economic benefits of the small-scale mining sector are lost through poor practice in mining, processing and marketing the target minerals. They then add mercury to the metal and wait for middle-men who come to the site mostly in the evening to buy the commodity. The miners work in groups, and distribute ground ore equally to individuals or smaller groups. The miners market the gold through brokers, who frequent the mining sites in the evening. Exploitation by middlemen and cartels means that the benefits rest buried in pockets foreigners. However since gold marketing is unregulated, tonnes of gold produced by small-scale miners is said to be smuggled out of the country by dealers who have put out gold smith shops in Kakamega town.

#### *E. Social Problems*

The dangers of involving children in gold mining areas are common. Thus they lose school days and in the process damage their health. Welfare officers rely on the goodwill of people to report cases but this doesn't happen often because parents encourage their children to seek employment at the mines. The children are involved either in actual extraction or in ancillary services such as selling food. Besides working in unhygienic conditions, workers have abandoned social life responsibilities to be at the mines looking for this 'black gold'.

### III. PROPOSED IMPROVEMENTS

Engaging all small-scale miners at the exploration stage could support efforts to reduce and eliminate mercury use. Planning how best to extract a deposit will help to maximize the resource, minimize land use, and improve gold production, which in turn will make mercury use more affordable and sustainable. Ore deposit type dictates the type of extraction possible, which in turn dictates how mercury is used (and potentially eliminated). Best practices in one situation cannot necessarily be applied elsewhere. Mercury reduction approaches must fit the ore type and current practices. Mercury is effective in extracting very small gold particles. For an effective and safe process, mercury should be reclaimed instead of vapourising it into air.

Grain size of the gold particles must be investigated and understood so that adequate and efficient liberation of the gold particles is accomplished during milling. Running tests on gold liberation and recovery is important and will reveal how to improve gold recovery. A programme of gold grain size measurement, therefore, can be carried out. Samples of gold

concentrate can be collected from mine sites to establish a baseline of gold grain size data. There was virtually no information available about the grain size of gold ores from the ASM mining region

Alternative, effective and safer substitutes for mercury in gold processing like the well-known retorts can virtually eliminate the release of mercury from the final stages of gold ore processing but projects to introduce them as a best practice in AGSM areas have met limited success. The borax method has been suggested where borax is used as a flux for smelting gold out of heavy mineral concentrates. The alternative methods encourage reduction of mercury use, re-use of mercury or its elimination.

Mercury pollution problems are generally caused by socio-economic barriers to the adoption of better practices. Periodic trainings should be mounted for the miners, where the miners will be engaged and trained on the mining, processing and safety and environmental protection. However, even with education, environmental-impact arguments are often not enough to convince miners to swap to non-toxic gold extraction methods because these often require financial investments which most small scale miners are not able or willing to make. Hence active research on methods of extraction at low cost can be undertaken.

The comminution process should be improved through development of affordable and efficient machinery for the miners. Control technology should aim at reducing noise to acceptable levels by action on the work environment. The miners should be urged to use masks to avoid inhaling dust and mercury fumes and use plastic gloves when handling mercury

Most of the minerals, especially non-industrial ones, produced in the country are used locally and/or exported without value being added owing to inadequate capacity to do so. A gold resource centre targeting small scale miners can be established in the relevant counties these centers can offer technical support, value addition and act as accumulation centers where miners can have access. These will shorten the marketing chain and increase the benefits to the miners and bring ASGM into the formal economy thus representing an excellent method of transferring wealth to rural communities: These methods, which detect and measure the amounts of other elements as well as gold, include atomic absorption spectrometry, neutron activation, and inductively coupled plasma-atomic emission spectrometry. These methods enable rapid and extremely sensitive analyses to be made on large samples

The gold resource centre should be established with collaboration between county governments and Higher learning institutions. The institution can mount relevant research geared toward practical solutions to problems of AGSM. The proposed research and educational measures should include; training of small-scale mining personnel, planners and consultants in suitable educational facilities, for example in the areas of gold analysis, geology, mineral-deposit, geological mapping and mineral exploration organization and techniques in mining and beneficiation, work safety, marketing and mineral economics. Other areas are mercury usage and effects to the environment, Impacts of

mining, mining methods, gold particle size, processing methods, noise and dust control and smelting of gold.

There are other measures which the government has been encouraging like fencing off mining areas, covering tunnels, timbering of tunnels to avoid caving in, digging of breathers for pumping air into the mines to avoid suffocation and use of strong and fastened hand pulleys. In addition the miners have been directed to mine during daytime, anchor generators and draining pipes on the ground surface to avoid accumulation of fumes in the holes, use protective clothing, avoid working under the influence of alcohol and ensure they have a well-equipped first aid kit on site. These efforts have not yielded much success hence the approach in training and awareness must be evaluated to yield measurable success.

#### IV. CONCLUSION

AGSM miners face challenges running from prospecting, mining processing and marketing with social problems. A holistic approach can be used to solve this challenges. Empowering AGSM with knowledge and protecting them from exploitation will play a major role in empowering the rural population. If the miners are economically stable they will be able to acquire gold mining equipment now available to the formal ASM sector, including sluices and shaking tables, jigs, gold savers and centrifugal concentrators. The challenges facing small scale miners are not unique to the case study.

The proposed Mining bill 2014 policy for to assist the Artisanal and Small-Scale Mining Operations, mainstream and formalize artisanal and small scale mining operations. Small-scale mining operations undertaken by Kenyans offer opportunities to support rural livelihoods and develop entrepreneurship. The government must assist their efforts to operate in an economically and environmentally sustainable manner through enforcement of the new bill once enacted.

#### ACKNOWLEDGEMENT

We would like to acknowledge JKUAT for sponsoring research in Rosterman area in Kakamega County. We would also like to appreciate Hon. Peninah Mukabane Minister for Energy and Environment Kakamega County, other team members, , Mr Tom Waka, Alvin Bett who have given ardent support for the research.

#### REFERENCES

- [1] M. V. Marcello, M. M. Stephen, F. B. Randy and . K. Bern, Manual for Training Artisanal and Small-Scale Gold Miners, Vienna: UNIDO, 2006.
- [2] K. Harold, L. N. William and P. A. Roger , "History of gold".
- [3] R. o. K. Kenya, "Promotion of extractive and mineral processing industries in the eac, Kenya status," 2013.
- [4] D. J. Watson and B. J. van , Review of VSF-Belgium's Turkana Emergency Livestock Off-take Intervention, 2005, ILRI (aka ILCA and ILRAD), 2008.
- [5] M. V. Marcello and F. B. Randy, "Protocols for Environmental and Health Assessment of Mercury



- Released by Artisanal and Small-Scale Gold Miners,"  
Protocols for Environmental and Health Assessment of  
Mercury UNIDO, Vienna, 2004.
- [6] W. H. Organization, "Mercury Exposure and Health  
Impacts among Individuals in the Artisanal and Small-  
Scale Gold Mining (ASGM) Community," Public Health  
and Environment, 20 Avenue Appia, 1211 Geneva 27,  
Switzerland, 2013.
- [7] W. A. Peter and N.-O. Leoncio , "The Borax Method of  
Gold Extraction for Small-Scale Miners," *Blacksmith  
Institute Journal of Health & Pollution*, vol. 3, June  
2012.
- [8] H. Thomas , H. Felix and P. Michael , Artisanal and  
Small scale mining: Challenges and opportunities,  
London, 2003.
- [9] C. Machandara, "Rush for gold claims three lives at  
Rosterman in kakamega town," *Kakamega times*, 14  
April 2011.
- [10] C. Mahandara, "Gold miners seek state help," *Kakamega  
Times*, 27 August 2011.
- [11] U. N. E. Programme, Reducing Mercury Use in Artisanal  
and Small-Scale Gold Mining: A Practical Guide, 2012.
- [12] A. Oketch, "Kakamega's gold belt holds no glitter for  
impoverished miners," 21 September 2014.
- [13] A. Kareithi, "Kenya can produce 12 tonnes of gold every  
year, says mines commissioner," *Standard digital News*,  
11 04 2014.
- [14] H. . H. Colin and . I. G. Berenice, "ENGINEERING  
NOISE CONTROL".
- [15] S. W. S. Australia, "NOISE IN THE WORKPLACE,  
What you should know," 2008.
- [16] "MINERALS AND MINING POLICY ZERO DRAFT,"  
2013.
- [17] "Humanitarian news an analysis," 9 February 2012.
- [18] "Gold mining beats school any day," *humanitarian news  
and analysis*, 9 February 2012.

# Prediction of in-cylinder Conditions for a 2-stroke Marine Diesel Engine

Elijah Musango Munyao, Jiang Guohe, Meshack Hawi, John Gerald Odhiambo

**Abstract**—Valuable information about the effect of engine design change, fuel type and engine operating conditions on the combustion process and engine performance, can be obtained by use of different established models. Among these models, the first law single zone is the easiest and simplest tool to use for quick preliminary analysis of engine performance. To test this model, geometrical parameters for a marine diesel engine, 6S35ME, manufactured and distributed by Man & Diesel Company were used. However, the model is flexible in that it can be used with engines of different geometrical configurations. It is formulated to be used with liquid fuels, like light diesel oil and Marine Diesel Oil.

The single zone combustion models are used in Matlab formulation. The output from the model includes the cylinder volume variation, apparent heat release, heat losses, in-cylinder pressure and average gas temperature. These are presented in this paper, from which the performance of the engine at the design stage or during working life can be approximated. The information obtained in this work can also be used as boundary conditions in thermal and structural analyses to determine the strength of engine components.

**Keywords:** Single Zone Combustion Models, Engine performance, in-cylinder conditions.

## NOMENCLATURE

Q	Heat input used in ideal engine process models, KJ
T	Temperature, K
$C_p$	Specific heat capacity at constant pressure, KJ/kgK
$C_v$	Specific heat capacity at constant volume, KJ/kgK
$R_g$	Gas constant, KJ/kgK
$\gamma$	Specific heats ratio
$\eta_c$	Combustion efficiency
V	Cylinder volume, m <sup>3</sup>
r	Compression ratio
$V_d$	Displaced cylinder volume, m <sup>3</sup>
$V_c$	Clearance volume, m <sup>3</sup>
$V_t$	Total cylinder volume, m <sup>3</sup>
B	Cylinder diameter, m
l	Connecting rod length, m
a	Crank radius, m
L	Stroke length, m
A	Heat transfer area, m <sup>2</sup>
$A_{ch}$	Combustion chamber Area, m <sup>2</sup>
$\theta$	Crank angle, degrees
s	Piston position, m
$\lambda$	Stoichiometric mixture excess air coefficient

m	Constant used in equation 11
$C_2$	Constant used in Equation 8
$h_{-t}$	Heat transfer coefficient for in-cylinder gases, W/m <sup>2</sup> K
LHV	Lower heating value of the fuel oil, kJ/kg
m	Mass of air in the cylinder contents, kg
$M_f$	Mass of fuel in the cylinder, kg
N	Engine speed, revolutions per minute
P	In-cylinder pressure, Pa
$Q_{ht}$	Heat transfer, kJ
$Q_{in}$	Heat added from burning fuel used in computational engine analysis, kJ
$Q_{loss}$	Heat losses, kJ
$T_r$	Reference state gas temperature, K
$T_i$	Inlet temperature, K
$T_w$	Cylinder wall temperature, K
$C_m$	Mean speed of piston, m/s
$V_r$	Reference state volume, m <sup>3</sup>
U	Average cylinder gas velocity, m/s
W	Work, kJ
$\theta_{sc}$	Start of combustion, degree
$\theta_d$	Duration of combustion, in degrees
x	Non- dimensional burn-fraction

## ABBREVIATIONS

EPO	Exhaust Port opens
EPC	Exhaust Port closes
TDC	Top Dead Center
ATDC	After Top Dead Center
BDC	Bottom Dead Center
ABDC	After Bottom Dead Center
AFR	Air-fuel ratio, dimensionless

## I. INTRODUCTION

Experimentally tested and proven models have been used by researchers to simulate variation of thermodynamic process parameters for internal combustion engines with the crankshaft position; for instance the pressure, temperature and heat flux [1], [2], [3]. The pressure variation over an engine cycle is a function of volume changes, gross heat released from the burning fuel, the heat release rate, heat losses from the cylinder, crankshaft revolution speed, specific heats ratio, among other important factors. The heat generated during combustion depends on the mass and calorific value of fuel injected into the cylinder, quality of the charge air and combustion efficiency. The relationship between mass of air in the cylinder chamber and the fuel injected is usually more conveniently described using the air fuel ratio; however the equivalence ratio and the excess air coefficient have been widely used [4]. Computational thermodynamic analysis of

E. M. Munyao, Author, Department of Marine Engineering, JKUAT  
J. Guohe, Shanghai Maritime University, Merchant Marine College  
M. Hawi, Department of Mechanical Engineering, JKUAT  
G. Odhiambo, Department of Marine Engineering, JKUAT

internal combustion engine process has been used widely to study how changes of different parameters of the engine affect the overall performance of the engine.

This paper used this approach to determine the instantaneous values of engine cylinder pressure, temperature and heat transfer coefficient as functions of the crank position over a crank cycle. The engine geometries and thermodynamic models were used in the cycle modeling process with emphasis being put on the compression, combustion and the expansion phases of the engine cycle. The computational thermodynamic approach is greatly useful during the engine development phase, where the engine process modeling is used to predict the overall performance of the engine. This is important since cost and development time is greatly reduced. The cost factor is reduced, since the need to use physical engine models is reduced or completely eliminated.

## II. THE ENGINE GEOMETRY

The piston moves back and forth inside the cylinder and transmits force via the connecting rod and crank mechanism to the driving shaft. The steady rotation of the crank produces a cyclical motion of the piston. The piston comes to rest at the TDC crank position and at the BDC crank position when the cylinder volume is minimum and maximum respectively. The minimum cylinder volume is the clearance volume. The volume swept out by the piston, that is, the difference between  $V_t$  and  $V_c$ , is the swept or displaced volume. More about the geometrical properties of reciprocating engines is discussed in [4].

The cylinder volume  $V$  at any position  $\theta$  is given by:

$$V = V_c + \frac{\pi B^2}{4} (l + a - s) \quad (1)$$

In equation 1,  $s$  is the distance between the crank axis and crosshead pin. It is given by:

$$s = a \cos \theta + (l^2 - a^2 \sin^2 \theta)^{1/2} \quad (2)$$

In terms of the crank angle,  $\theta$ , equation 1 can be rewritten as:

$$\frac{V}{V_c} = 1 + \frac{1}{2} (r - 1) \left[ \frac{l}{a} + 1 - \cos \theta \left( \left( \frac{l}{a} \right)^2 - \sin^2 \theta \right)^{1/2} \right] \quad (3)$$

At any crank angle position, the combustion chamber surface area  $A$  can be written as:

$$A = A_{ch} + A_p + \pi B(l + a - s) \quad (4)$$

## III. THERMODYNAMIC ANALYSIS OF THE ENGINE CYLINDER CONDITIONS

Using the first law of thermodynamics for a closed system, the governing equation for the rate of change of in-cylinder pressure with the crank angles is:

$$\frac{dP}{d\theta} = \frac{\gamma - 1}{V} \left( \frac{dQ_m}{d\theta} - \frac{dQ_{ht}}{d\theta} \right) - \frac{\gamma P}{V} \frac{dV}{d\theta} + \frac{P}{\gamma - 1} \frac{d\gamma}{d\theta} \quad (5)$$

In equation 5,  $\frac{dQ_m}{d\theta}$  is the rate of heat loss expressed as:

$$\frac{dQ_{ht}}{d\theta} = h_c A(\theta) (T - T_w) \left( \frac{1}{\omega} \right) \quad (6)$$

The convective heat transfer used is as given by woshni [5], [6]:

$$h_c = 0.820 B^{-0.2} P^{0.8} U^{0.8} T^{-0.55} \quad (7)$$

The characteristic velocity of burned gas  $U$  is given by:

$$U(\theta) = 2.28 C_m + C_2 \left( \frac{V_d T_r}{P_r V_r} \right) (P(\theta) - P_m) \quad (8)$$

The quantities  $T_r$ ,  $V_r$ ,  $P_r$  are determined from a known reference position, for instance at inlet valve closure or start of combustion.  $P_m$  - the motoring pressure.  $C_2 = 0.00324$  during combustion and expansion processes.

The mean piston velocity was taken as:

$$C_m = \frac{2LN}{60} \quad (9)$$

The mass of fuel injected into the combustion chamber,  $M_f$  is calculated using the ideal gas relation using the instantaneous values at the beginning of fuel injection, given by:

$$M_f = \frac{PV}{R_g T} (\lambda (AFR))^{-1} \quad (10)$$

The Wiebe function is useful in predicting the burn fraction and burn rate in internal combustion engines operating with different combustion systems and fuels [7]. For the non-dimensional burn fraction  $x$  as a function of crank angle position [8]:

$$x = 1 - \exp \left( -6.908 \left( \frac{\theta - \theta_{sc}}{\theta_d} \right)^{m+1} \right) \quad (11)$$

The burn rate is given by the derivative of equation 11 as:

$$\frac{dx}{d\theta} = \frac{6.908(m+1)}{\theta_d} \left( \frac{\theta - \theta_{sc}}{\theta_d} \right)^m \exp \left( -6.908 \left( \frac{\theta - \theta_{sc}}{\theta_d} \right)^{m+1} \right) \quad (12)$$

The gross heat released in the cylinder due to combustion is given by:

$$Q_{in} = M_f LHV \quad (13)$$

Taking combustion efficiency into consideration, equation 13 becomes:

$$Q_m = \eta_c M_f LHV \quad (14)$$

Finally, the transient temperature of the gases in the cylinder as a function of crank angle can be determined using the equation of state expressed as:

$$T = \frac{P(\theta)V(\theta)}{mR_g} \quad (15)$$

#### IV. ENGINE PROCESS SIMULATION

Equations 1 through 15 were used in a MATLAB code to simulate the engine process. The cylinder temperature was taken as 485K [4]. A stoichiometric mixture excess air coefficient was used ( $\lambda=1$ ) and a constant specific heats ratio of 1.4 assumed in the simulation. Air-Fuel ratio was determined from previous test-runs of the engine. The LHV of the fuel, scavenging air pressure and temperature were obtained from the engine's specifications manual. Exhaust port closure time (EPC), exhaust port opening time (EPO) were taken as  $62^\circ\text{ABDC}$  and  $130^\circ\text{ATDC}$  respectively. The start and end of combustion times were taken as  $10^\circ\text{BTDC}$  and  $20^\circ\text{ATDC}$  respectively, which translates to combustion duration of  $30^\circ$ . This is within the range of  $30^\circ\text{-}50^\circ$  [4]. The fuel injection was taken to commence  $10^\circ\text{BTDC}$ . 98% combustion efficiency was assumed [4]. The conditions of the engine at specified maximum continuous rating (SMCR) were used.

TABLE 3-1 SHOWS THE ENGINE GEOMETRICAL AND OPERATIONAL SPECIFICATIONS USED IN THE ANALYSIS.

Engine model	Man & Diesel 6S35ME-B9
Cylinder bore*stroke	350mm*1,500mm
Power at SMCR (KW)	3570 @142rpm
Ambient Temperature	45°C
Connecting Rod length	1,550mm
Firing order	1-5-3-4-2-6 (clockwise when viewed from ship fore)
Scavenging pressure at SMCR	2.65bars
Atmospheric pressure	1.01bars

#### V. RESULTS

From the simulation, in cylinder parameters of the test engine were predicted as shown in figures 1 through 4.

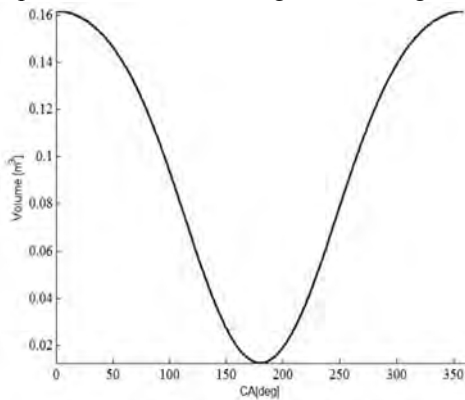

Figure 1: Cylinder volume vs. Crank angle

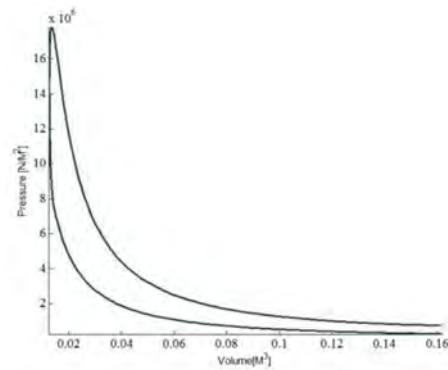

Figure 2: Cylinder Pressure vs. Crank angle

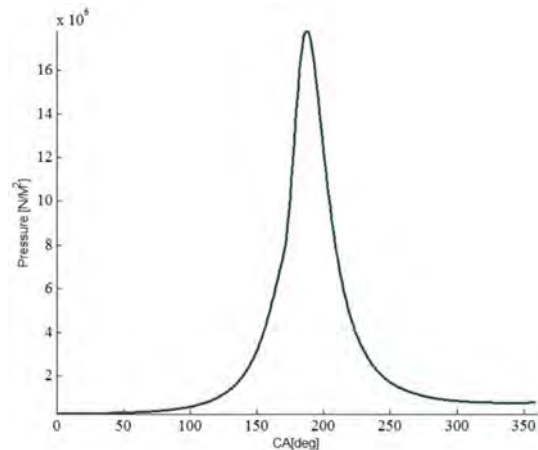

Figure 3: Cylinder Pressure vs. Crank angle

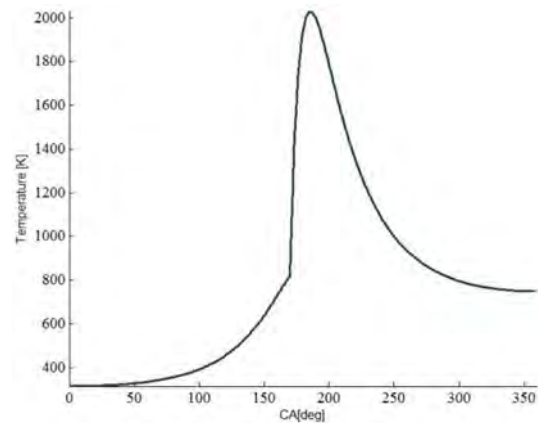

Figure 4: Cylinder Temperature vs. Crank angle

#### VI. DISCUSSION

Figure 1 shows the cylinder volume cycle, ( $t = 0$  seconds) and decreases to the minimum volume halfway of the cycle duration, then increases to maximum volume at the end of the cycle ( $t=0.4225$  seconds). The calculated peak pressure was 17.056MPa, while the stated value from the engine manual was 18MPa. The maximum pressure occurred at  $6^\circ\text{ATDC}$ . From literature review, it is pointed out that maximum pressure of a diesel engine occurs between  $5\text{-}10^\circ\text{ATDC}$  [4]. Figures 3 and 4 show the temperature and convective heat transfer coefficient respectively. The maximum calculated

transient temperature was 2050K and the maximum transient heat transfer coefficient was found to be 1580KW/M<sup>2</sup>K. All these values occurred at/ close to the crank angle at which the maximum pressure was attained. Although the models obtained using computational thermodynamic analysis of the engine were simplified by making some assumptions, the integrity of the analysis was sound and the results obtained were reliable.

## V. CONCLUSION

Computational thermodynamic analysis of the engine process is also useful in providing realistic estimations of other performance parameters of the engine, such as break mean effective pressure, thermal efficiency and engine power.

The results from this analysis can be used as thermal and structural boundary conditions in a finite element analysis of the engine components. This can be done during the engine design stage to ascertain that the final engine design will withstand the combustion pressures and temperatures or during the engine's operating period to predict the state of the engine components.

## RECOMMENDATIONS

In this prediction model, the ratio of specific heats is assumed constant ( $\gamma=1.4$ ). However, this is a function of the prevailing cylinder temperature. Therefore this prediction model can be improved by having the ratio vary with the prevailing cylinder temperature over the crank cycle.

## REFERENCES

- [1] A. Sakhrieha, E. Abu-Nadab, I. Al-Hintic, A. Al-Ghandoord and B. Akashe, "Computational Thermodynamic Analysis of Compression Ignition Engine," *International Communications in Heat and Mass Transfer*, pp. 299-303, 2010.
- [2] B. V. Rao, K. M. Murthy and G. A. P. Rao, "Modeling Diesel Engine Flow Processes for Performance and Emissions," in *International Conference on Trends in Industrial and Mechanical engineering (ICTIME)*, Dubai, 2012.
- [3] E. Abu-Nada, I. Al-Hinti, A. Al-Sarkhi and B. Akash, "Thermodynamic Modeling of Spark Ignition Engine: Effects of Temperature Dependant Specific Heats," *International Communication in Heat and Mass Transfer*, pp. 1264-1272, 2006.
- [4] J. B. Heywood, *Internal Combustion Engine Fundamentals*, New York: McGraw Hill Inc., 1988.
- [5] C. Fergusson and A. Kirkpatrick, *Internal Combustion Engines: Applied thermo-sciences*, New York: Wiley, 2001.
- [6] M. A. Ceviz and I. Kaymaz, "Temperature and Air-Fuel Ratio Dependent Specific Heat Ratio Functions for Lean Burned and Unburned Mixture," *Energy Conversion and Management*, pp. 2387-2404, 2005.
- [7] E. Abu-Nada, B. Akash, I. Al-Hinti and A. Al-Sarkhi, "Performance of Spark Ignition Engine under the Effect of Friction using a Gas Mixture Model," *Journal of Energy Institute*, vol. 4, no. 8, 2009.
- [8] J. I. Ghojel, "Review of The Development and Applications of the Wiebe Function: A Tribute to the Contribution of Ivan Wiebe to Engine Research," *International Journal of Engine Research*, vol. 11, pp. 298-312, 2010.
- [9] A. F. P S Shenoy, "Dynamic analysis of loads and stresses in connecting rods," *Journal of Mechanical Engineering*, pp. 615-624, 2006.
- [10] P. S. Shenoy, "Dynamic Load Analysis and Optimization of Connecting rod," 2004.

# In-situ Synthesis of Al-based Composites Reinforced with TiB<sub>2</sub>-TiC- Al<sub>2</sub>O<sub>3</sub> Ceramic Particulates

Takahiro A.<sup>1\*</sup>, Tonoko K.<sup>1</sup>, Onda T.<sup>1</sup>, and Chen Z.<sup>1</sup>

**Abstract** - Metal matrix composites (MMCs) reinforced with ceramic particulates have been attractive as high specific strength materials utilized in automobile and aerospace industries. In order to enhance refinement and dispersibility of the ceramic particulates, the synthesis process with in-situ reactions has been investigated. The in-situ synthesis can avoid complex and harmful processes of powder handling and produce fine inclusions in the matrix with rather lower costs than conventional fabrication methods. In this study, the Al-based composites with TiC, TiB<sub>2</sub> and Al<sub>2</sub>O<sub>3</sub> particulates have been prepared by the following reaction,  $(x+4)Al + 3TiO_2 + B_4C \rightarrow x Al + 2TiB_2 + TiC + 2Al_2O_3$ , where x determines the ratio of ceramic reinforcements and Al matrix. Compacts of the mixed powders were sintered at various temperatures ranging from 800 to 1200°C for 10 minutes in a reducing atmosphere (Ar-5%H<sub>2</sub>).

The reaction path has been elucidated by XRD measurements. It was found that the reaction mentioned above has completed at 1200°C and the temperature could be reduced when finer powder was used as the starting material. The obtained porous sintered samples were subjected to subsequent extrusion processing. The extrudates containing ceramic reinforcements up to 20 vol% exhibited high density and homogeneous microstructures with fine ceramic particulates. The mechanical properties such as tensile strength were remarkably improved when the ceramic particulates were induced by in-situ reactions, as a result of enhanced dispersion strengthening.

**Keywords**- Metal matrix composite, in-situ synthesis, ceramic particulate, reinforcement.

<sup>1</sup>Department of Mechanical and Aerospace Engineering, Tottori University, Tottori, Japan (Corresponding Author E-mail: akao@mech.tottori-u.ac.jp)

1. Shadrack Kimanthi - Department of TIE, JKUAT
2. Kenneth Kamumbu - IEET, JKUAT
3. Philip Kiprono Talam - GEGIS, DEKUT
4. Richard N. Mbiu - Department of Mechanical Engineering, JKUAT
5. Anil Kumar - Dept of Chemical & Process Engineering, Moi University
6. Suleiman Iguda ladan - Department of Basic and Applied Sciences Hassan Usman Katsina Polytechnic Katsina, Katsina State Nigeria
7. Lucas O. Mogaka - Department of Electrical and Electronics Engineering, TUM
8. Benard Mumo Makaa - Department of Telecommunication & Information Engineering, JKUAT
9. Charles Mwaniki - Department of Electrical and Electronics Engineering, JKUAT
10. Akinyele A. Idowu - Nigeria
11. Douglas Osiemo - Department of Physics, University of Eldoret
12. Ruth Kara Njeri - Department of Electrical and Electronics Engineering, JKUAT
13. Bernard Rop - Department of Mining, Materials and Petroleum Engineering, JKUAT
14. Seroni Anyona - Department of Geological Science, School of Earth Sciences, Institute of Mining and Mineral Processing Southern Eastern Kenya University
15. Mary Kamunyu - GEGIS, DEKUT
16. Gilbert Kipng'etich Bett, - Department of Mining, Materials and Petroleum Engineering, JKUAT
17. Atsutaka Tamura - Department of Mechanical and Aerospace Engineering, Graduate School of Engineering, Tottori University, JAPAN
18. Faith Jeruto Birir - GEGIS, DEKUT
19. Magdalene Wanjagi Njuki - GEGIS, DEKUT
20. Adline Kerubo Bikeri - Department of Electrical and Electronics Engineering, JKUAT
21. Charles Ndungu - Kenya Power
22. Joseph Nanzala Munyendo - GEGIS, JKUAT
23. Kabini Samuel Karanja - Mechatronic Engineering, JKUAT
24. Kevin Mwongera - Department of Telecommunication & Information Engineering, JKUAT
25. Henry Abuga - GEGIS, DEKUT
26. Rehema Ndeda - Department of Mechanical Engineering, University of Botswana
27. Antony N. Kamau - IEET, JKUAT
28. Enoch Kimanzi - Department of Mechanical Engineering, JKUAT
29. Peter M. Macharia - School of Pure and Applied Sciences, Pwani University
30. Timothy Kiptui Kangogo - Department of Mechanical Engineering, JKUAT
31. Richard N. Kariuki - Nairobi Institute of Technology
32. John Gerald Odhiambo - Department of Marine Engineering and Maritime Operations, JKUAT
33. Bernard O. Owiti - Department of Mechanical Engineering, JKUAT
34. Meshack Hawi - Department of Mechanical Engineering, JKUAT
35. Allan Mugambi Kaburu - Department of Civil, Construction and Environmental Engineering, JKUAT
36. Ogongo Bernard Ochieng - Department of Natural Product and Post-Harvest Technology, Coastal and Marine Fisheries Programme, KMFRI
37. James Kinyua Muriuki - Kenya Power
38. John Otieno Odhiambo - Department of Marine Engineering and Maritime Operations, JKUAT
39. Ariel Mutegi - Department of Electrical & Electronic Engineering, JKUAT

40. Oteri Omae - Department of Telecommunication and Information Engineering, JKUAT
41. J. Bittar Odoyo - Department of Extra Mural Studies, University of Nairobi
42. Jackis Aukah - Kenya Industrial Research and Development Institute
43. Abraham Chirchir - Department of Chemical and Process Engineering, Moi University
44. Anthony K. Muchiri - Department of Mechanical Engineering, JKUAT
45. Takahiro Akao - Department of Mechanical and Aerospace Engineering, Graduate School of Engineering, Tottori University, JAPAN
46. Joseph Muguthu - Department of Mechanical Engineering, Kenyatta University, Nairobi Kenya
47. Matthew Ndeto Kyalo - Department of Mechanical Engineering, JKUAT
48. James Wamai Mwangi -Department of Mechatronic Engineering JKUAT





JSRE is an international peer reviewed open access journal that publishes high quality research quarterly.

The journal enjoys a global list of prestigious academic reviewers drawn from leading international universities and the editors are committed to a fair and efficient handling of manuscripts received.

We have an online manuscript management where authors can submit and track their manuscripts editorial process through our portal.

JSRE is currently receiving submissions for Vol 2, Issue 1 at <http://www.jkuat-sri.com/ojs/index.php/>

Tel. No.:+254 0202574960